

A novel dielectric sensor for process monitoring of carbon fibre composites manufacture

K. I. Tifkitsis*, A. A. Skordos

School of Aerospace, Transport and Manufacturing, Cranfield University, Bedford, MK43
0AL, UK

*corresponding author's email: k.tifkitsis@cranfield.ac.uk; Tel: + 44 (0) 1234 750111;

Abstract

A dielectric sensor appropriate for process monitoring of composites manufacture with carbon reinforcement has been developed in this study. The sensor concept overcomes problems of electrical sorting and interference with the electric field occurring when electrical/dielectric sensors are used with carbon reinforcement. The sensor comprises two uniformly twisted insulated copper wires. Two sensor designs based on the same concept have been implemented; a lineal sensor for flow front position tracking and a woven sensor used to monitor the cure. Resin Transfer Moulding (RTM) processing has been employed to evaluate the lineal sensor performance against visual monitoring of the flow front. Vacuum Assisted RTM (VARTM) has been carried out to validate the results of the woven cure sensor against calorimetric cure kinetics models. Both the lineal flow and woven cure sensors provide accurate monitoring signals.

Keywords: A. Carbon fibres; B. Curing; E. Resin Transfer Moulding (RTM); D. Process monitoring.

1. Introduction

The development in recent years of process monitoring techniques appropriate for continuous fibre composite manufacture has been motivated by the need to track critical manufacturing parameters such as flow front position and cure reaction progress. Lineal and spot sensors have been developed for monitoring the filling in liquid moulding processes. Lineal sensors

based on dielectrics [1,2], fibre optics [3], time domain reflectometry [4] and DC [5,6] methods can perform continuous monitoring of the flow front position mainly in the presence of glass fibre reinforcement. Local sensors, such as thermocouples [7], fibre optic sensors [8,9] and pressure transducers [10–12], implemented in the filling stage can instantly provide information of resin arrival, whilst the technology applied is in a mature stage for integration in industrial applications.

Cure monitoring systems are based on tracking the evolution of a physical quantity connected either directly or indirectly to the cure state. Near-infrared [13–15] and infrared spectroscopy [16,17] provide direct chemical information on the cure evolution. The correlation between fluorescence and viscosity has been used as the basis for monitoring of the cure [18–20]. Similarly, the sensitivity of ultrasonic wave propagation to macroscopic polymer structure, viscosity and modulus has been used to capture the evolution of the curing reaction [21,22]. The refractive index is directly related to the density of the resin and can be used for cure monitoring through fibre optic sensors based on the densification occurring during cross linking [9,23]. Dielectric cure monitoring methods are based on the dependence of the electric and dielectric properties on structural properties of the resin and have been used successfully to follow the degree of cure, viscosity and vitrification [24–31]. Monitoring based on impedance/dielectric spectroscopy is considered advantageous due to the high sensitivity of sensor response, the robustness and low cost of the measurement setup and the capability for incorporation on tooling.

High specification parts, which are the primary target of monitoring methodologies, usually involve carbon fibres. The conductive nature of carbon fibres introduces measurement issues in cases where the sensing system operation is based on measuring the electromagnetic or optical response of the resin system. Lineal dielectric flow sensors and cure dielectric

sensors are appropriate for use with non-conductive reinforcement [1] as presence of carbon disturbs the electric field, whilst using the conductive reinforcement as one of the electrodes of the sensing system involves significant practical complexity as it requires electrical insulation of the reinforcement from the tooling assembly [2]. The solution adopted for carbon composites in cure applications is to cover the sensor with a permeable non-conductive material such as glass cloth or a polymer weave [24,29,30]. This type of solution increases the intrusiveness of the sensing system and causes a difference between the material monitored and the material of the composite. Fibre optics techniques for flow monitoring rely on the evanescent field around the optical fibre [8,9], which is also disturbed by absorption by the carbon. Vacuum sensors [32], pressure sensors [12], ultrasonic [33] or thermal probes [7] are not affected by the presence of carbon fibre, and thus can be utilised for this purpose. The implementation of pressure transducers within the mould provides local information regarding the resin arrival [11], whilst 2-D pressure sensors allow the mapping of pressure distribution within the mould cavity area and thus the resin filling pattern. However, the accuracy of the measured flow front depends on the sensitivity of the monitoring system [34, 35].

Furthermore, the implementation of 2-D pressure sensors requires significant adjustments and modifications of the mould cavity, increasing the monitoring system complexity. The utilisation of thermocouples placed in discrete positions within the part for monitoring of resin arrival does not depend on fabric type, but it is limited only to cases in which there are high temperature differences between resin and the mould [7,36]. Furthermore, the integration of thermocouples within the preform induces local disturbances in preform architecture. The local character of these sensors makes them not appropriate to monitor continuously the flow front, whilst the implementation of multi spot sensor arrays at sufficient resolution within the

tooling assembly is cumbersome in practice and increases the intrusiveness of the monitoring system.

The present study focuses on the development of a dielectric sensor capable of operating with the presence of carbon reinforcement. The main concept is used for the design of two sensor types; a lineal sensor used to monitor the flow front and a woven arrangement able to track the cure. Sensor signals are analysed using the corresponding equivalent circuits. The lineal sensor is validated in RTM processing against visual monitoring. The cure sensor is evaluated in isothermal neat resin cure experiments and in VARTM processing of carbon fibre composites.

2. Sensor set-up

2.1 Principle of operation

The design of the dielectric sensor is illustrated in Figure 1a. It comprises two twisted solid copper wires coated by an insulator. The insulating coating prevents contact of the copper wire with the conductive fibres. An electric field is formed between the wires upon application of voltage. The field goes through the insulating coating and penetrates the gaps between wires. The twisting enhances the robustness and sensitivity of the sensor. The signal strength is proportional to the actual length of wires and of the corresponding contact region (L_{act}) which depends on the wire diameter (D) and twist per unit length (T) as follows [37]:

$$L_{act} = L\sqrt{1 + \pi^2 D^2 T^2} \quad (1)$$

where L denotes the length of the sensor. Increasing the twist per unit length results in greater actual length, which leads to higher sensitivity.

The twisting makes the pair more robust and eliminates the need of additional bonding needed to hold the wires in places. In comparison to a pair of parallel wires, the twisted configuration is also advantageous in terms of interference of carbon reinforcement with the field. The gaps

formed between parallel wires are exposed to carbon reinforcement reducing the signal strength. In the case of a twisted pair the reinforcement interferes with the fringing field; however, the constantly changing orientation of the gap between the wires keeps limits the penetration of reinforcement in this region. The sensor principle can be adapted to address both flow and cure monitoring applications.

A lineal sensor made using the twisted pair can be used to monitor the resin flow front position. An example of the configuration of the lineal sensor in an RTM tool is presented in Figure 1b. The measurement area of the sensor is divided into two parts: the wetted area impregnated by resin which fills the gaps between the wires and the dry in which the gaps are filled with air. As the flow process progresses the wetted area percentage increases, whilst the dry area decreases. The very large contrast in dielectric properties between liquid resin and air results in significant sensitivity of the sensor response to its covered length. The sensor can be placed either on the tool surface in contact with the carbon fabric or between two layers of reinforcement. One potential configuration is where the sensor is placed on the lower tooling in contact with the fabric as illustrated in Figure 1b, in which case the presence of the sensor only causes a small disturbance to the fibre architecture, similar in size to the diameter of the wires. If the wire diameter is significantly smaller than that of the tow width the disturbance is negligible and similar to the resin rich channels that are present in the composite material.

In the case of cure monitoring, the local material state is estimated based on the sensitivity of electrical properties on cure progress. For the sensing concept based on the twisted pair proposed here, the strength of the signal is governed by the total length of the sensor. Utilising a woven configuration allows fitting a large length within a small area. This results in sufficient sensitivity combined with local cure sensing.

2.2 Analysis of lineal flow sensor signal

The lineal sensor response has been examined following the analysis in [1]. The electric circuit representing the sensor response is illustrated in Figure 2. The wetted and dry part of the sensor are connected in parallel, whilst within each part the element corresponding to the gaps and the element corresponding to the coating are connected in series. The admittance per unit length of the wetted part is:

$$y_w = \frac{y_{wg}y_c}{y_{wg}+y_c} \quad (2)$$

and of the dry part

$$y_d = \frac{y_{dg}y_c}{y_{dg}+y_c} \quad (3)$$

where y_c is the admittance per unit length of the coating, y_{wg} the admittance per unit length of the filled gaps and y_{dg} the admittance per unit length of the dry gaps.

The admittance measured by the sensor is:

$$Y = L_w \frac{y_{wg}y_c}{y_{wg}+y_c} + (L - L_w) \frac{y_{dg}y_c}{y_{dg}+y_c} \quad (4)$$

where the length of the sensor is L and the length covered by resin L_w . Eq (4) considering Eq (2) and (3) can be rearranged as follows:

$$L_w = \frac{Y - Y_o}{Y_f - Y_o} L \quad (5)$$

where $Y_f = Ly_w$ is the admittance of the fully wetted sensor and $Y_o = Ly_d$ the admittance of the dry sensor.

Eq (5) describes the linear response of sensor measurement to flow front position and allows the online estimation of the length of sensor covered by resin using the measured admittance, the admittance of the dry sensor and the admittance of the fully wetted sensor. It should be noted that the latter two need to be determined for the conditions of the measurement, matching the reinforcement architecture and pressure applied during impregnation.

2.3 Analysis of cure sensor signal

In order to uncover the quantitative characteristics of the resin reaction during cure process it is necessary to translate the dielectric/impedance signal to information related to resin reaction state. The behaviour of a thermoset under an AC excitation is governed by three phenomena: dipolar relaxation; charge migration and; electrode polarisation. These phenomena can be represented by the equivalent circuit illustrated in Figure 3a [38]. The circuit comprises constant phase elements (CPE) representing the electrode-material interface connected in series with a sub-circuit corresponding to dipolar relaxation and migration charges. It is expected that the action of the insulating coating will be incorporated into this part of the equivalent circuit coating, with the CPE representing both electrode effects and the capacitive response of the insulator. The presence of dipolar relaxation is represented by introducing a capacitance (C_{sd}), in series with a resistance (R_{sd}) which corresponds to static dipoles due to molecular asymmetry of the material, connected in parallel with a capacitance of the dipoles induced by electric field (C_{id}). The migrating charges mechanism is accounted by a resistor (R_m) connected in parallel with the sub-circuit of dipolar relaxation. The imaginary part of the complex impedance of the equivalent circuit can be expressed as follows:

$$Z'' = \frac{R_m[\omega^3 C_{sd}^2 R_{sd}^2 R_m C_{id} + \omega R_m (C_{id} + C_{sd})]}{\omega^2 (C_{sd} R_m + C_{sd} R_{sd} + C_{id} R_m)^2 + (\omega^2 C_{sd} R_{sd} R_m C_{id} - 1)^2} + \frac{2}{(A_e \omega)^n} \quad (6)$$

where A_e and n are coefficients of the constant phase element and ω the angular frequency.

For a lossy dielectric such as a curing epoxy resin with electrical behaviour dominated by migrating charges and a small contribution by dipolar relaxation, the equivalent circuit can be simplified by replacing the sub-circuit corresponding to dipolar relaxation and migration charges with a parallel R-C circuit [39]. Hence, Eq (6) is transformed as follows:

$$Z'' = \frac{\omega CR_m^2}{1 + \omega^2 C^2 R_m^2} + \frac{2}{(A_e \omega)^n} \quad (7)$$

The first term in the left hand side of Eq (7) denotes the material impedance (Z_m'') and the second term the constant phase element. Figure 3b illustrates the imaginary impedance spectrum of the simplified equivalent circuit. The imaginary impedance decreases linearly in a log-log plot with a slope equal to the exponent of the electrode polarisation and coating term (n) in the low frequency zone of the spectrum where this term dominates the signal. The peak region is dominated by migrating charges, whilst the local imaginary impedance maximum (IIM) is related directly to the resistor corresponding to migrating charges ($Z_{max}'' \approx R_m/2$) [39]. The high frequency zone is governed by the capacitive elements of the circuit, which in the case of the simplified spectrum expressed by Eq (7), is manifested as a line with a slope of -1 in a log-log plot. In the case of the more complex behaviour represented by Eq (6), the high frequency response incorporates a small shoulder corresponding to dipolar relaxation with a linear behaviour with a slope of -1 at very high frequencies.

The imaginary impedance maximum is used in practice to monitor the cure based on the dependence of resistivity on migrating charges mobility, which in turn depends on local material viscosity [40]. This can be implemented through a normalised form of the IIM [26,27,39] or through treating its time derivative as a signal equivalent to heat flow in differential scanning calorimetry [41].

2.4 Experimental set-up

The evaluation of the lineal sensor was performed during RTM processing of two carbon fibre/epoxy composite panels under different injection pressures. The RTM tool is a rectangular cavity with dimensions 900×340×3.3 mm. The reinforcement material was a 5H satin weave carbon fabric (Hexcel HexForce® G0926) with an areal density of 375 g/m² [42]. The resin system was Hexcel HexFlow® RTM6 epoxy [43]. The preform with dimensions

800×340×3.3 mm comprised nine fabric layers in a [(0F/90F)₂/0F/(90F/0F)₂] sequence resulting in a volume fraction of 57%. The filling was carried out at a constant temperature of 120 °C under a pressure of 2 and 3 bar for the first and second RTM run respectively, with the simultaneous application of vacuum at 10 mbar. The curing was performed after the end of filling at 160 °C for 2 h where the heating ramp was equal to 1.5 °C/min. The lineal sensor was made by twisting two 136-AWP solid copper wires with polyurethane enamel coating [44] using a hand drill. The diameter of each wire is 127 μm, whilst the pitch of the twist is 500 twists/m as illustrated in Figure 4. The lineal sensor with length 800 mm was placed in the centre of cavity of the RTM tool as illustrated in Figure 5 and was connected to a Solartron 1260 Impedance Analyser. Impedance data were acquired over seven frequencies swept logarithmically in the 100 Hz - 100 KHz range. The analyser communicates with a computer via an IEEE interface. An in-house code developed in LabVIEW was utilised to drive the measurements and acquire the data. The code controls the data acquisition from the impedance analyser and thermocouples where necessary. It operates in a loop from the highest frequency to the lowest frequency, triggering a measurement and the corresponding acquisition at each frequency, followed by acquisition of temperature data where applicable. The impedance analyser data are acquired in the form of a resistance and capacitance of the overall system, which are assumed to be connected in parallel. These are subsequently translated to real and imaginary values for further processing of results. A toughened glass top plate was used in the RTM tool to allow the visual measurement of the flow front for validation purposes using a digital camera acquiring images during the filling. Eq (5) was used to calculate the flow front position from the admittance data for the two RTM runs. The experimental set-up and the data acquisition system are illustrated in Figure 6.

The cure sensor was made using 1.2 m of twisted wire and a nominal weaving distance of 2 mm. The miniature loom illustrated in Figure 7a is made of ABS (Acrylonitrile Butadiene Styrene) filament and was produced in a Lulzbot TAZ 5 3D printer. Figures 6a and 6b present the sensor production and the resulting woven configuration with dimensions 20×20×0.25 mm. Two isothermal experiments were carried out at 150 °C and 160 °C using neat RTM6 resin to establish the cure monitoring capability of the woven sensor. The experimental set-up used comprises a Eurotherm 2408 controller and a heating mantle mounted on a hollow copper cylinder with a diameter of 5 mm. The cure sensor connected to the impedance analyser was immersed in a glass tube, with a diameter of 5 mm, containing the liquid resin placed in the heated copper cylinder. In addition to the control thermocouple placed in the copper cylinder, a thermocouple was placed in the tube to measure the actual thermal profile the resin follows.

The response of the cure sensor in the presence of carbon reinforcement was assessed in VARTM processing of a carbon fibre/epoxy composite plate. The preform, with in-plane dimensions of 150×75 mm, comprised six plies of Hexcel HexForce® G0926 woven fabric in a [0F/90F]₃ layup sequence resulting in a total thickness of 2.2 mm and fibre volume fraction of 57%. Infusion with Hexcel HexFlow® RTM6 resin was carried out at 120 °C under vacuum and cure at 160 °C for 2 h. A flow media (VACslip 10P1-1420 PTFE coated glass fabric) was placed on top of the preform to assist the flow of the resin. A thermocouple was placed on the lower tool of the VARTM process in contact with the fabric to monitor the temperature evolution during the process. The cure sensor was placed centrally on the tooling lower side of the VARTM assembly. Impedance data were acquired over 25 frequencies swept logarithmically in the 1 Hz - 1 MHz range using the Solartron 1260 Impedance Analyser. The

results of temperature monitoring were used to compute the evolution of the degree of cure based on a non-parametric kinetics model of the cure of the resin system of this study [45].

3. Results and discussion

3.1 Flow monitoring

The evolution of the flow front for the case of the 3 bar injection is shown in Figure 8. It can be observed that there is race tracking on the sides of the mould, affecting the flow in a region extending to about 80 mm from the edge by the end of filling. The filling pattern is uniform in the central region of the mould where the sensor is placed. The filling pattern is similar in the case of the 2 bar filling. It is expected that variations in the flow front position across the thickness direction are negligible due to the low thickness of material (3.3 mm).

Figure 9 illustrates the lineal sensor response for the 2 and 3 bar RTM experiments and compares it with the visual flow front measurements. It can be observed that the sensor response represented as real length using Eq (5) follows closely the parabolic behaviour of the flow front position during the whole duration of the impregnation stage. The sensor signal is sensitive to changes in flow front speed with an error that never exceeds 5% of the actual front position measured visually.

According to Eq (5) the length estimated using the admittance measurements is the ratio of two complex numbers. In an ideal situation, in which the sensor field, material state and environmental conditions are identical across the length of the sensor, the numerator and denominator of the ratio are in phase resulting in a negligible imaginary part of the estimated length. Deviations from these ideal conditions, as well as measurement noise, cause higher values of imaginary length. Consequently, the sensor response provides a direct indication of measurement and corresponding analysis errors [1]. In the results presented in Figure 9 the imaginary impedance length is predominantly between -10 and 10 mm with a few extreme

values reaching an absolute value of 25 mm. This is below 3% of the overall length, indicating a high quality estimation based on the real part of the length computed using Eq (5).

The results obtained using the flow sensor show clearly that the concept developed is applicable to liquid moulding of carbon composites under industrial conditions. The sensor withstands RTM level pressures, whilst its placement between the metal tool and the carbon fabric tested here is the worst case scenario in terms of potential interference by conductors as well as potential damage to the insulating coating. The air/resin pockets formed around the sensor by the fabric are sufficient to guarantee high sensitivity to filling state. The disturbance in the fabric architecture caused by the presence of the sensor is minimal, whilst the sensor is easily removed after curing if it is placed on the surface. The fabric conforms around the sensor forming a groove with a maximum dimension of around 250 μm as illustrated in Figure 10. The dimension of the disturbance is governed by the wire diameter, which can be minimised by selection of a thinner coated wire for the twisted pair.

3.2 Cure monitoring

The evolution of the imaginary impedance spectrum during the isothermal cure of neat resin at 150 °C and 160 °C is illustrated in Figures 11a and b respectively. A linear log-log reduction of imaginary impedance at low frequency is observed as expected. At intermediate frequencies, the plot shows a shoulder at the location where the local imaginary impedance peak is expected, whilst at high frequency the plot reverts to a linear log-log behaviour. The manifestation of migrating charges as a shoulder in the spectrum instead of a peak, which is the case of standard sensors [41], can be attributed to the insulating coating of the twisted wires, which behaves as an additional - mostly capacitive - element acting alongside electrode polarisation and results in a higher effective value of A_e in the equivalent circuit. In terms of

physical phenomena the presence of the coating limits direct charge migration towards the electrodes, with the migration mostly occurring up to the boundary of the coating and the curing material and limited by the polarisation of the insulating layer as the field alternates. As the curing progresses the spectrum shifts to lower frequencies and high impedances. This behaviour, which is the same as observed with conventional sensing elements, is attributed to the effect of increasing viscosity during the cure, which results in reduced mobility of charge carriers and increased timescale in their response.

The manifestation of migrating charges as a shoulder instead of a peak in imaginary impedance does not allow use of the conventional analysis based on the IIM to monitor progress of cure [26,27,39]. For the spectra obtained by the sensor presented here, this is carried out by estimating the values of A_e and n for the CPE element of the equivalent circuit from the low frequency response and subtracting the contribution of the constant phase element corresponding to electrode polarisation and the insulating coating from Eq (7). Using the log-log plot of imaginary impedance versus frequency at low frequencies and linear regression, the values of A_e and n were found to be constant during the experiments and equal to $100 \text{ MOhm/s}^{0.96}$ and 0.96 respectively. The resulting spectrum of material impedance after subtraction of the constant phase element from Eq (7) is illustrated in Figure 12 alongside the original spectrum. The material impedance spectrum incorporates a pronounced peak which can be used instead of the IIM for estimating the state of cure.

Figures 13a and b illustrate the evolution of the maximum of Z_m'' for the two isothermal neat resin experiments and compare it with the results of the cure kinetics model based on calorimetric data [45]. In both temperatures the response of the cure sensor follows closely the resin reaction. The results highlight the cure sensor efficiency in terms of monitoring the degree of cure evolution during the whole process.

Imaginary impedance spectroscopy can also be used for identifying the vitrification point of the resin during the cure. This follows from the influence of vitrification on dipolar relaxation and is manifested as a secondary shoulder in the evolution of imaginary impedance at fixed frequency [46]. Figures 14a and b illustrate the imaginary impedance evolution at 1 KHz and 10 KHz alongside the specific heat capacity for the isothermal curing of neat resin at 150 °C and 160 °C. The imaginary impedance at fixed frequency shows a two-step behaviour; the first major step corresponding to the effect of curing on migrating charges and the secondary step to vitrification. The vitrification is manifested at 50 - 70 min and 35 - 55 min at 150°C and 160°C respectively. This period can be compared with the vitrification time identified as a step change in specific heat capacity during the cure. The specific heat capacity for the resin system of this study was calculated using the model reported in [47]. The step in specific heat capacity curves occurs at 65 min and 50 min at 150°C and 160°C respectively, which shows that the sensor indications of vitrification are in agreement with the calorimetric manifestation of the phenomenon. The comparison highlights the capability of the cure sensor to identify the vitrification of the resin during isothermal runs.

The results of cure monitoring during VARTM of a carbon reinforced composite are illustrated in Figure 15. The response is very similar to the case of the neat resin, showing that the sensor monitors resin material changes in the presence of carbon reinforcement and is able to follow the cure. The reaction progress as monitored by the cure sensor is in very good agreement with the corresponding estimation of the cure kinetics model, as observed in Figure 15a. Figure 15b illustrates the imaginary impedance evolution at fixed frequencies alongside the evolution of specific heat capacity. The vitrification is manifested as the second step of imaginary impedance during the cure process between 40-50 min. These results show that the sensing concept can be used effectively for monitoring the cure in the presence of carbon

reinforcement. The signal sensitivity, expressed as the logarithmic change in the imaginary impedance maximum for a unit change in degree of cure, obtained for the length of twisted wire corresponding to the woven sensor (1.2 m) is about 20% higher than the sensitivity of a conventional interdigitated electrode sensor (Gel Instrumente AG DE-Sensor) of similar in plane dimensions [41]. More specifically the sensitivity during the isothermal cure of neat resin is equal to 1 order of magnitude per 20% progress of cure and 1 order of magnitude per 25% progress of cure for the sensor presented here and the conventional interdigitated sensor respectively. Despite the fact that the insulation covers the sensor electrodes increasing the contribution of the constant phase element, its sensitivity is higher than a conventional sensor covering a similar area mainly.

Signal sensitivity for both the flow and cure sensor can be enhanced by increasing the number of twists per unit length, this increasing the actual wire length, as expressed by Eq (1). In the current configuration of 500 twists/m and a wire diameter of 127 μm the increase in length is very limited, at about 2%, to play a significant role. However, increasing the number of twists per unit length can intensify this effect. The maximum pitch angle possible for wire of any diameter is 50.5° [37], which for the diameter of the wire used in this work corresponds to about 3000 twists/m. According to Eq (1) using the maximum pitch angle would result in an increase in wire length of about 57%, which can have a significant effect on sensor sensitivity.

There is a trade-off between the increase in pitch angle and an increase in cross sectional dimensions of the sensor. The sensor cross sectional outline at a single location, can be approximated by an ellipse with a major axis equal to two wire diameters and a minor axis increasing from one wire diameter for the case of zero twist (two parallel wires) approaching to two wire diameters for maximum twisting (pitch angle of 50.5°). In the implementation

reported here. The maximum effective cross sectional dimensions of the twisted wire approach 0.25 mm, whilst in the woven cure sensor this translates to a maximum thickness of about 0.5 mm. These dimensions can be reduced significantly by selecting a wire of lower diameter.

4 Conclusions

A new approach of dielectric sensing has been developed overcoming limitations in flow and cure monitoring due to the presence of conductive carbon-fibre reinforcement. A lineal and a woven sensor based on the same concept have been designed for flow front and cure reaction progress monitoring. Validation RTM tests have been conducted demonstrating the accuracy and robustness of the flow sensor. The lineal character of the sensor lends itself to applications where continuous monitoring is appropriate, whereas simultaneous use of multiple sensors can provide the means for industrial control of flow processes in complex parts and geometries. The cure sensor can also operate in industrial processing of carbon reinforced composites yielding information on progress of cure and the point of vitrification. The capability demonstrated here is the same as that of state the art systems used for cure monitoring of neat resin or non-conductive reinforcement such as glass. This has significant industrial implications given that application of monitoring and control is far more relevant in high end applications dominated by the utilisation of carbon fibre reinforcements.

In addition to the capability to operate during the manufacturing of carbon reinforced composites the sensing concept has a low cost in terms of both raw materials and manufacturing method. Furthermore, it is applicable to non-conductive reinforcement and compatible with current industrial and research dielectric cure monitoring systems. The geometry and material of the sensor can be optimised further to allow full exploitation of the concept presented in this work in the composites manufacturing industry. The contribution of

wire insulation can be controlled through selection of a material that minimises its influence, while making sure that its behaviour is highly stable at temperatures relevant to composites processing. In high-end applications the disturbance in fabric architecture, introduced by the sensor, can be a limitation. The ability to scale down the size of the sensor -currently at about 250 μm – by utilising thinner insulated wires can enhance the non-intrusive character of the concept. Furthermore, the form of the sensing element lends itself to direct incorporation onto fabrics, offering potential routes for producing smart materials with process monitoring capabilities.

Acknowledgments

This work was supported by the Engineering and Physical Sciences Research Council, through the Grant RPOACM (EP/K031430/1). Data underlying this study can be accessed through the Cranfield University repository at <https://doi.org/10.17862/cranfield.rd.7160720>.

References

- [1] Skordos AA, Karkanas PI, Partridge IK. A dielectric sensor for measuring flow in resin transfer moulding. *Meas Sci Technol* 2000;11(1):25–31.
- [2] Skordos AA, Partridge IK. Dielectric flow sensing in resin transfer moulding of carbon fibre reinforced composites. *Plast Rubber Compos Process Appl* 2000;29(8):391–4.
- [3] Kueh SRM, Advani SG, Parnas RS. Sensor placement study for online flow monitoring in liquid composite molding. *Polym Compos* 2000;21(3):436–49.
- [4] Dominauskas A, Heider D, Gillespie JW. Electric time-domain reflectometry distributed flow sensor. *Compos Part A Appl Sci Manuf* 2007;38(1):138–46.
- [5] Barooah P, Sun J. Lineal sensors for flow sensing in liquid injection molding of composites. *J Mater Process Manuf Sci* 1999;7(4):416–27.
- [6] Luthy T, Ermanni P. Linear direct current sensing system for flow monitoring in liquid

- composite moulding. *Compos - Part A Appl Sci Manuf* 2002;33(3):385–97.
- [7] Tuncol G, Danisman M, Kaynar A, Sozer EM. Constraints on monitoring resin flow in the resin transfer molding (RTM) process by using thermocouple sensors. *Compos Part A Appl Sci Manuf* 2007;38(5):1363–86.
- [8] Gupta N, Sundaram R. Fiber optic sensors for monitoring flow in vacuum enhanced resin infusion technology (VERITY) process. *Compos Part A Appl Sci Manuf* 2009;40(8):1065–70.
- [9] Lekakou C, Cook S, Deng Y, Ang TW, Reed GT. Optical fibre sensor for monitoring flow and resin curing in composites manufacturing. *Compos Part A Appl Sci Manuf* 2006;37(6):934–8.
- [10] Lynch K, Hubert P, Poursartip A. Use of a simple, inexpensive pressure sensor to measure hydrostatic resin pressure during processing of composite laminates. *Polym Compos* 1999;20(8):581–93.
- [11] Amico S, Lekakou C. An experimental study of the permeability and capillary pressure in resin-transfer moulding. *Compos Sci Technol* 2001;61(13):1945–59.
- [12] Di Fratta C, Klunker F, Ermanni P. A methodology for flow-front estimation in LCM processes based on pressure sensors. *Compos Part A Appl Sci Manuf* 2013;47(1):1–11.
- [13] Cossins S, Connell M, Cross B, Winter R, Kellar J. In situ near-IR cure monitoring of a model epoxy matrix composite. *Appl Spectrosc* 1996;50(7):900–5.
- [14] Mijovic J, Andjelic S. A study of reaction kinetics by near-Infrared Spectroscopy. 1. Comprehensive analysis of a model epoxy/amine system. *Macromolecules* 1995;28(8):2787–96.
- [15] Mijović J, Andjelić S. In situ real-time monitoring of reactive systems by remote fibre-optic near-infra-red spectroscopy. *Polymer (Guildf)* 1995;36(19):3783–6.

- [16] Fernando GF, Liu T, Crosby P, Doyle C, Martin A, Brooks D, et al. A multi-purpose optical fibre sensor design for fibre reinforced composite materials. *Meas Sci Technol* 1997;8(10):1065–79.
- [17] Mijović J, Andjelić S. Monitoring of reactive processing by remote mid infra-red spectroscopy. *Polymer (Guildf)* 1996;37(8):1295–303.
- [18] Levy RL, Schwab SD. Monitoring the composite curing process with a fluorescence-based fiber-optic sensor. *Polym Compos* 1991;12(2):96–101.
- [19] Stroeks A, Shmorhun M, Jamieson AM, Simha R. Cure monitoring of epoxy resins by excimer fluorescence. *Polymer (Guildf)* 1988;29(3):467–70.
- [20] Wang FW, Lowry RE, Fanconi BM. Novel fluorescence method for cure monitoring of epoxy resins. *Polymer (Guildf)* 1986;27(10):1529–32.
- [21] Maffezzoli A, Quarta E, Luprano VAM, Montagna G, Nicolais L. Cure monitoring of epoxy matrices for composites by ultrasonic wave propagation. *J Appl Polym Sci* 1999;73(9):1969–77.
- [22] Shepard DD, Smith KR. A new ultrasonic measurement system for the cure monitoring of thermosetting resins and composites. *J Therm Anal* 1997;49(1):95–100.
- [23] Liu YM, Ganesh C, Steele JPH, Jones JE. Fiber optic sensor development for real-time in-situ epoxy cure monitoring. *J Compos Mater* 1997;31(1):87–102.
- [24] Maistros GM, Partridge IK. Monitoring autoclave cure in commercial carbon fibre/epoxy composites. *Compos Part B Eng* 1998;29(3):245–50.
- [25] Bellucci F, Valentino M, Monetta T, Nicodemo L, Kenny J, Nicolais L, et al. Impedance spectroscopy of reactive polymers. 1. *J Polym Sci Part B Polym Phys* 1994;32(15):2519–27.
- [26] Mijović J, Andjelic S, Fitz B, Zurawsky W, Mondragon I, Bellucci F, et al. Impedance

- spectroscopy of reactive polymers. 3. Correlations between dielectric, spectroscopic, and rheological properties during cure of a trifunctional epoxy resin. *J Polym Sci Part B Polym Phys* 1996;34(2):379–88.
- [27] Day DR. Dielectric determination of cure state during non-isothermal cure. *Polym Eng Sci* 1989;29(5):334–8.
- [28] Levita G, Livi A, Rolla PA, Culicchi C. Dielectric monitoring of epoxy cure. *J Polym Sci Part B Polym Phys* 1996;34(16):2731–7.
- [29] McIlhagger A, Brown D, Hill B. Development of a dielectric system for the on-line cure monitoring of the resin transfer moulding process. *Compos Part A Appl Sci Manuf* 2000;31(12):1373–81.
- [30] Maistros GM, Partridge IK. Dielectric monitoring of cure in a commercial carbon-fibre composite. *Compos Sci Technol* 1995;53(4):355–9.
- [31] Mijović J, Kenny JM, Maffezzoli A, Trivisano A, Bellucci F, Nicolais L. The principles of dielectric measurements for in situ monitoring of composite processing. *Compos Sci Technol* 1993;49(3):277–90.
- [32] Antonucci V, Giordano M, Nicolais L, Calabrò A, Cusano A, Cutolo A, et al. Resin flow monitoring in resin film infusion process. *J Mater Process Technol* 2003;143–144(1):687–92.
- [33] Stöven T, Weyrauch F, Mitschang P, Neitzel M. Continuous monitoring of three-dimensional resin flow through a fibre preform. *Compos Part A Appl Sci Manuf* 2003;34(6):475–80.
- [34] Bickerton S, Comas-Cardona S, Razali I, Deléglise M, Walbran W, Binétruy C, et al. Spatial compaction and saturated permeability variations of fibre. 9th Int. Conf. Flow Process. Compos. Mater. Conf., 2008, p. 8–10.

- [35] Kratz J, Zschenderlein L, Levy A. In-process flow front detection in reclaimed carbon fibre mats using surface mapping sensor. 14th Int. Conf. flow Process. Compos. Mater., 2018, p. 1–2.
- [36] Wang P, Molimard J, Drapier S, Vautrin A, Minni JC. Monitoring the resin infusion manufacturing process under industrial environment using distributed sensors. *J Compos Mater* 2012;46(6):691–706.
- [37] Lefferson P. Twisted Magnet Wire Transmission Line. *IEEE Trans Parts, Hybrids, Packag* 1971;7(4):148–54.
- [38] Kazilas MC, Skordos AA, Partridge IK. Parameter estimation in equivalent circuit analysis of dielectric cure monitoring signals using genetic algorithms. *Inverse Probl Sci Eng* 2005;13(2):157–76.
- [39] Mijovic J, Yee CFW. Use of complex impedance to monitor the progress of reactions in epoxy/amine model systems. *Macromolecules* 1994;27(25):7287–93.
- [40] Fournier J, Williams G, Duch C, Aldridge GA. Changes in molecular dynamics during bulk polymerization of an epoxide-amine system as studied by dielectric relaxation spectroscopy. *Macromolecules* 1996;29(22):7097–107.
- [41] Skordos AA, Partridge IK. Determination of the degree of cure under dynamic and isothermal curing conditions with electrical impedance spectroscopy. *J Polym Sci Part B Polym Phys* 2004;42(1):146–54.
- [42] Hexcel® HexForce G0926, Product Data www.hexcel.com 2018.
- [43] Hexcel HexFlow® RTM6 epoxy system for Resin Transfer Moulding monocomponent system Product Data. www.hexcel.com. 2018.
- [44] Vishay Micro Measurements, 136-AWP solid wire, www.vishaypg.com 2018;
- [45] Skordos AA, Partridge IK. Cure kinetics modeling of epoxy resins using a non-

- parametric numerical procedure. *Polym Eng Sci* 2001;41(5):793–805.
- [46] Andjelić S, Mijović J, Bellucci F. Impedance spectroscopy of reactive polymers. 5. Impedance as a measure of chemical and physical changes in glass formers. *J Polym Sci Part B Polym Phys* 1998;36(4):641–53.
- [47] Struzziero G, Remy B, Skordos AA. Measurement of thermal conductivity of epoxy resins during cure. *J Appl Polym Sci* 2018;47015(8):1–10.

List of Figures

Figure 1 Lineal flow sensor: a) sensor geometry and; b) schematic representation of the operational principle of the flow sensor.

Figure 2 Electrical circuit representing the lineal sensor response.

Figure 3 a) Equivalent circuit representing the behaviour of a curing thermoset; b) Imaginary impedance spectrum of simplified equivalent circuit expressed by Eq (7).

Figure 4 Detailed view of the dielectric sensor.

Figure 5 Lineal sensor placed at the centre of the lower RTM tool.

Figure 6 RTM tool, injection machine and data acquisition system..

Figure 7 Cure sensor: a) production of sensor using miniature loom and; c) woven sensor.

Figure 8 Visual flow front evolution in the 3 bar filling experiment: a) 235 cm (3 min); b) 400 cm (8 min) and; c) 615 cm (16 min).

Figure 9 Comparison of visual with dielectric flow measurement for RTM filling at a) 2 bar and; b) 3 bar.

Figure 10 Microscopic view of preform deformation caused by the flow sensor.

Figure 11 Imaginary impedance spectra evolution during isothermal cure of neat resin at a) 150 °C and; b) 160 °C.

Figure 12 Imaginary impedance of equivalent circuit before and after subtraction of the CPE contribution: spectrum obtained at 64 min during the cure of neat RTM6 at 160°C.

Figure 13 Material impedance maximum evolution and comparison with fractional conversion computed using non-parametric kinetics for the isothermal cure of neat RTM6 resin at a) 150 °C and; b) 160 °C.

Figure 14 Imaginary impedance evolution at fixed frequencies and comparison with the evolution of specific heat capacity for the isothermal cure of neat RTM6 at a) 150 °C and; b) 160 °C.

Figure 15 VARTM curing of carbon fibre preform: a) material impedance maximum evolution and comparison with fractional conversion computed using non-parametric kinetics; b) imaginary impedance evolution at fixed frequencies and comparison with the evolution of specific heat capacity.

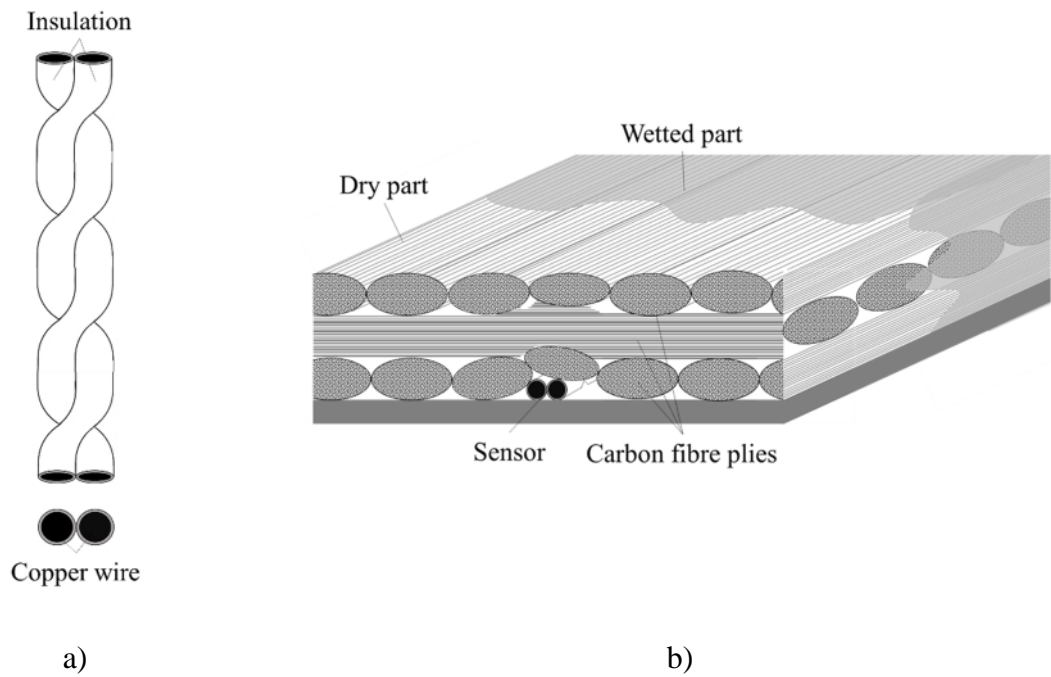

Figure 1 Lineal flow sensor: a) sensor geometry and; b) schematic representation of the operational principle of the flow sensor.

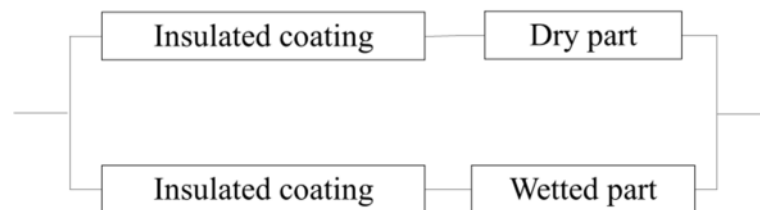

Figure 2 Electrical circuit representing the lineal sensor response.

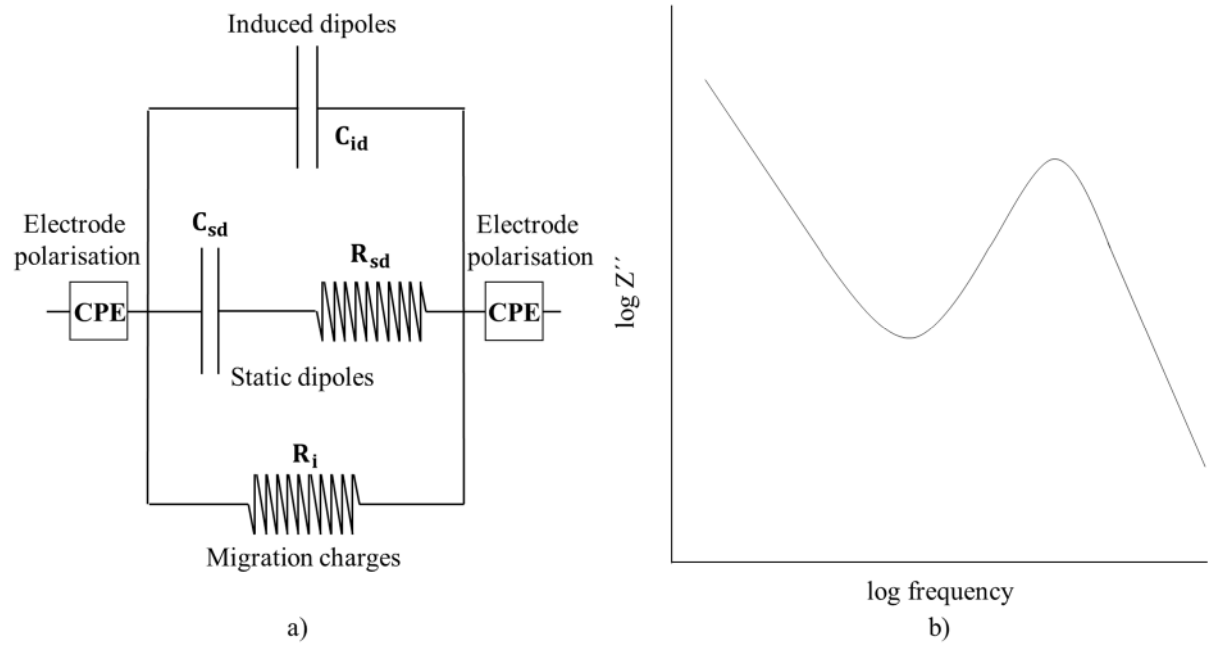

Figure 3 a) Equivalent circuit representing the behaviour of a curing thermoset; b) Imaginary impedance spectrum of simplified equivalent circuit expressed by Eq (7).

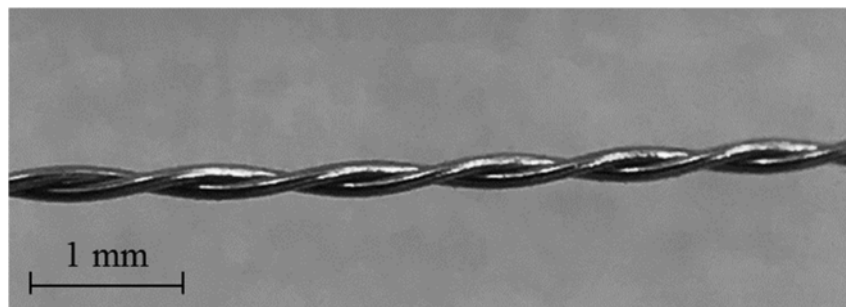

Figure 4 Detailed view of the dielectric sensor.

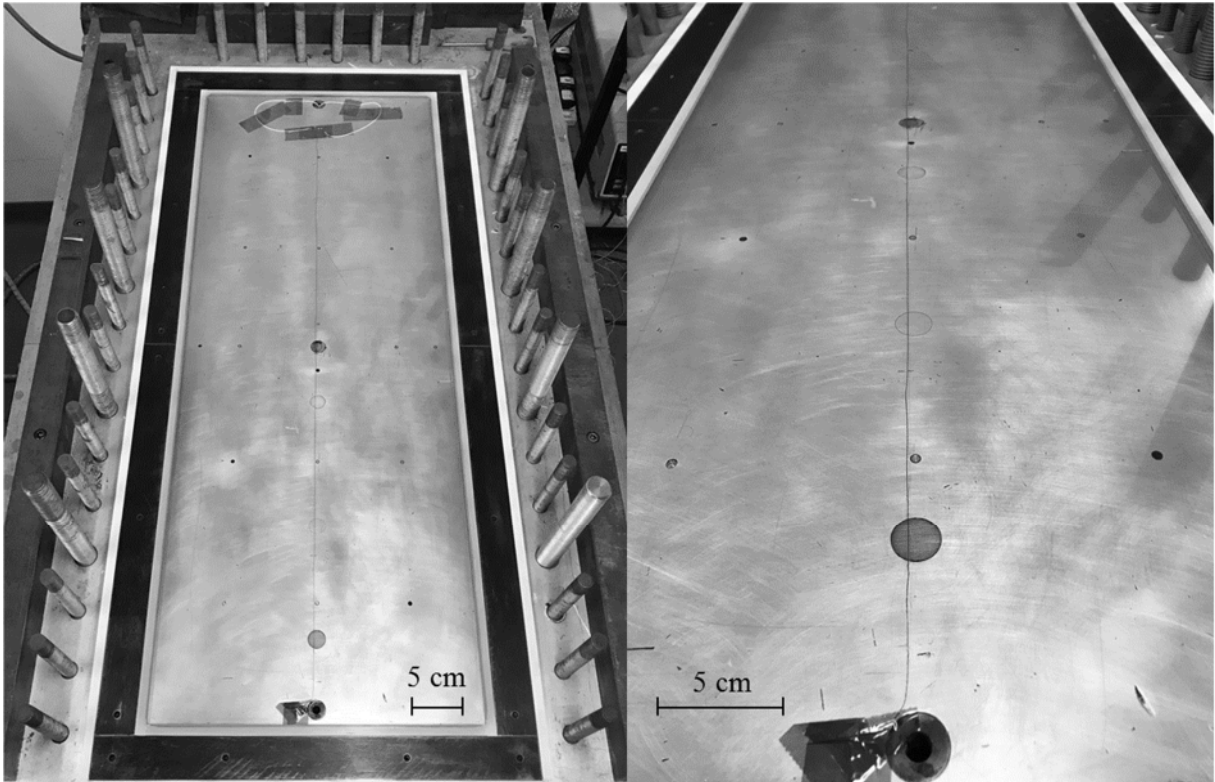
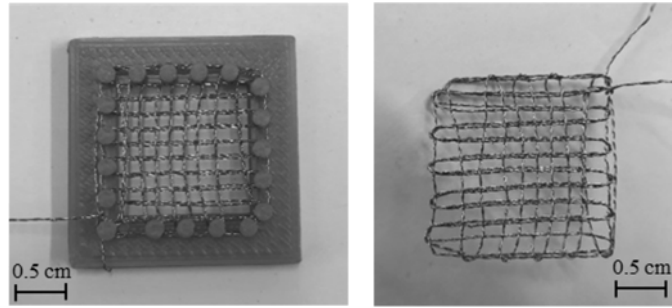

Figure 5 Lineal sensor placed at the centre of the lower RTM tool.



Figure 6 RTM tool, injection machine and data acquisition system.



a)

b)

Figure 7 Cure sensor: a) production of sensor using miniature loom and; c) woven sensor.

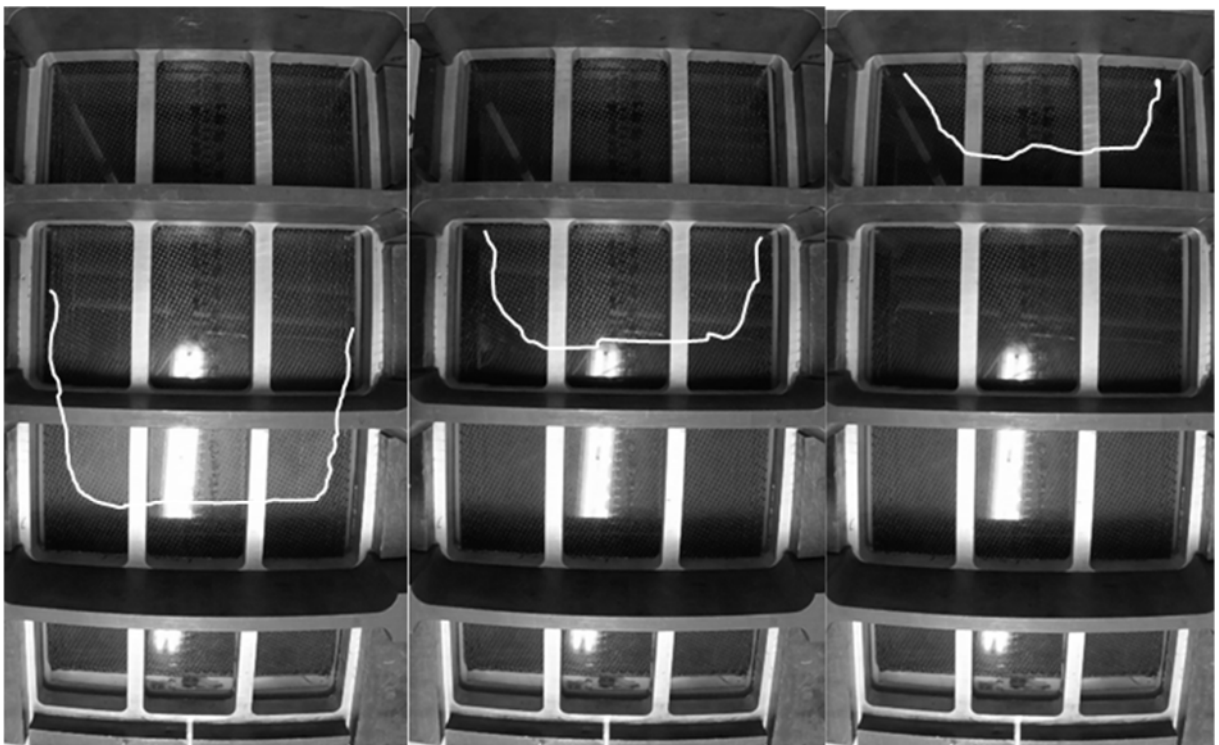

a)

b)

c)

Figure 8 Visual flow front evolution in the 3 bar filling experiment: a) 235 cm (3 min); b) 400 cm (8 min) and; c) 615 cm (16 min).

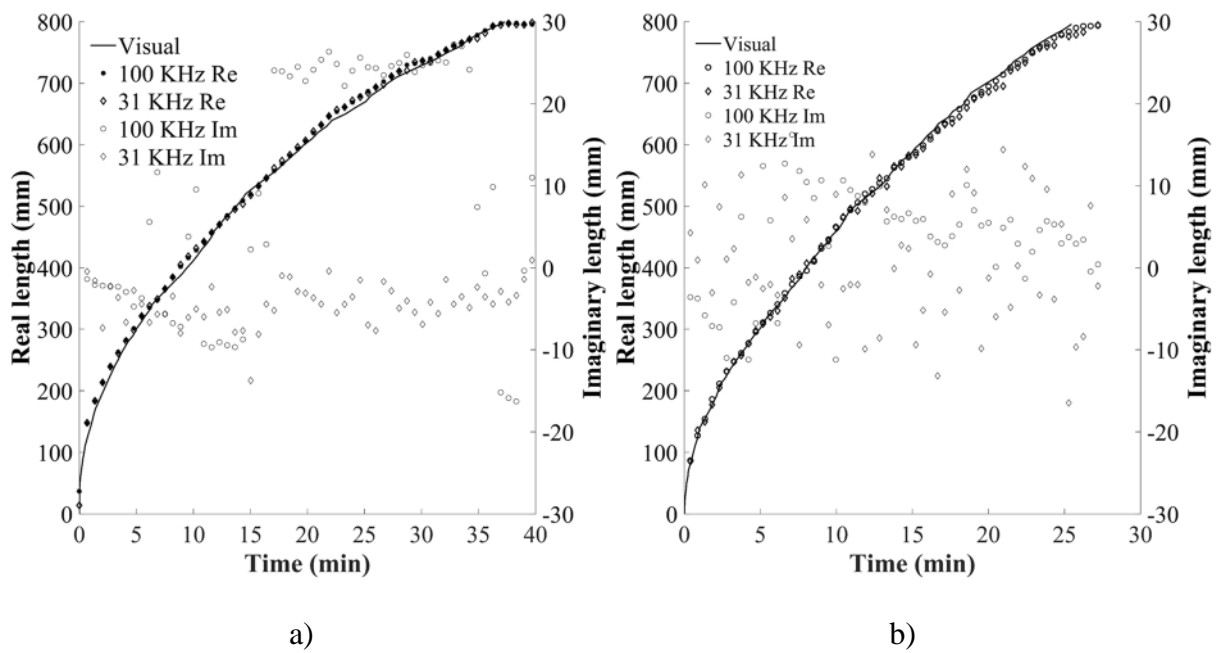

Figure 9 Comparison of visual with dielectric flow measurement for RTM filling at a) 2 bar and; b) 3 bar.

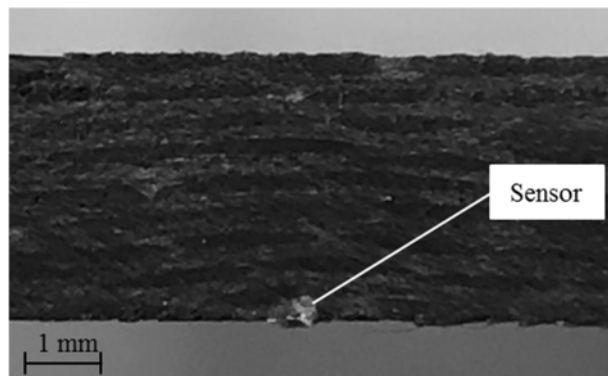

Figure 10 Microscopic view of preform deformation caused by the flow sensor.

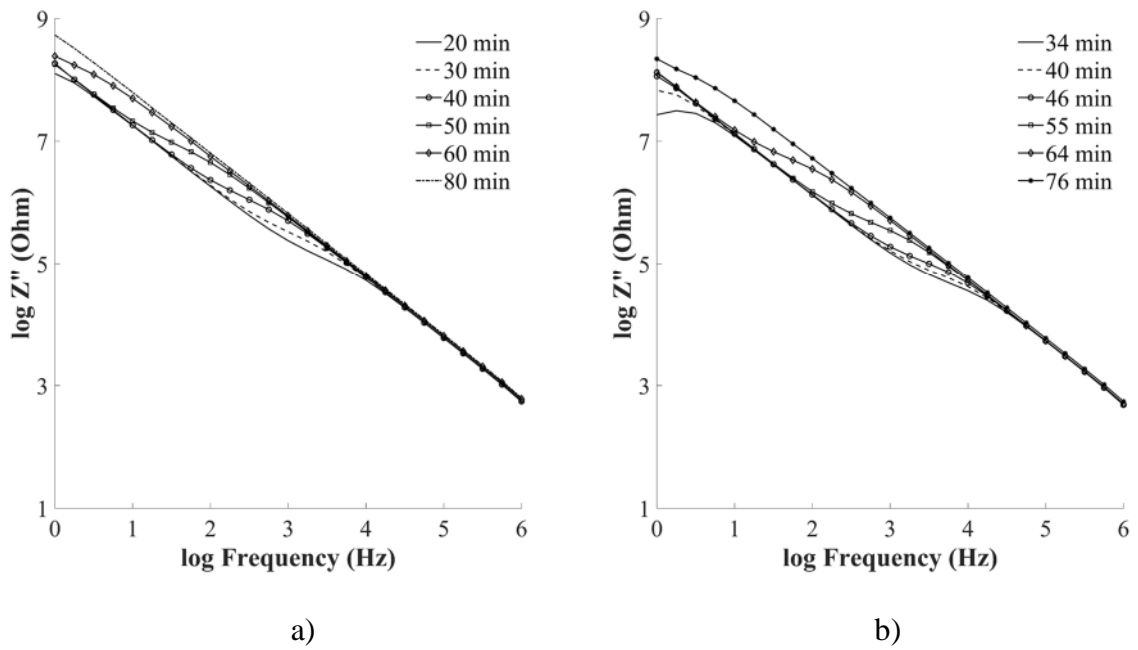

Figure 11 Imaginary impedance spectra evolution during isothermal cure of neat resin at a) 150 °C and; b) 160 °C.

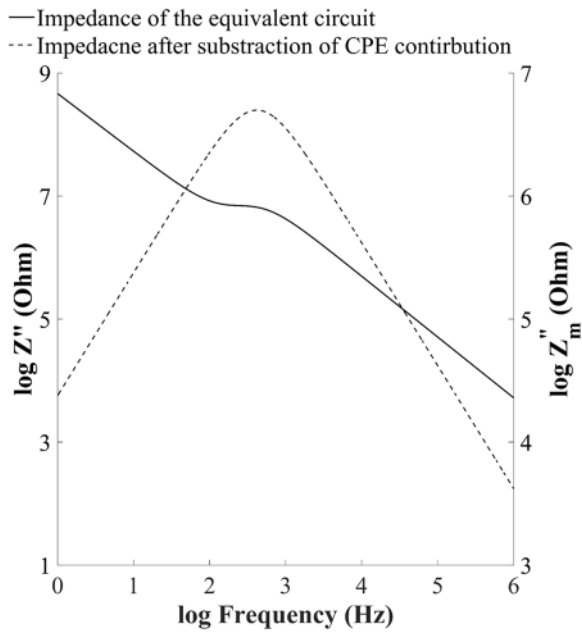

Figure 12 Imaginary impedance of equivalent circuit before and after subtraction of the CPE contribution: spectrum obtained at 64 min during the cure of neat RTM6 at 160°C.

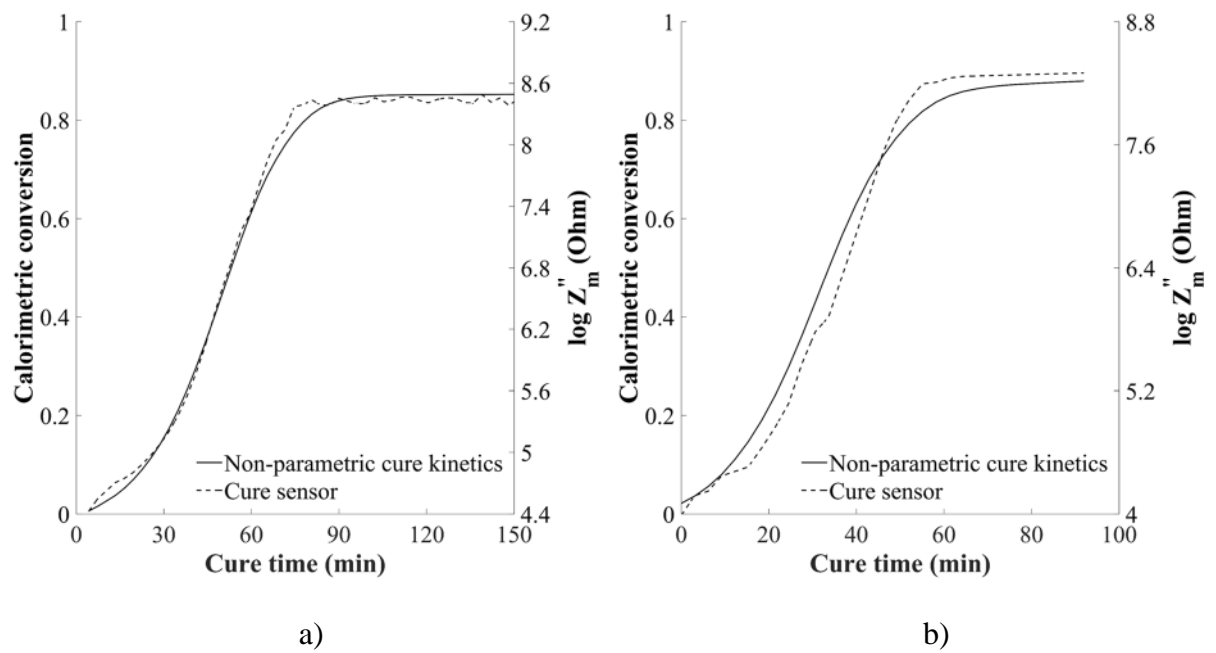

Figure 13 Material impedance maximum evolution and comparison with fractional conversion computed using non-parametric kinetics for the isothermal cure of neat RTM6 resin at a) 150 °C and; b) 160 °C.

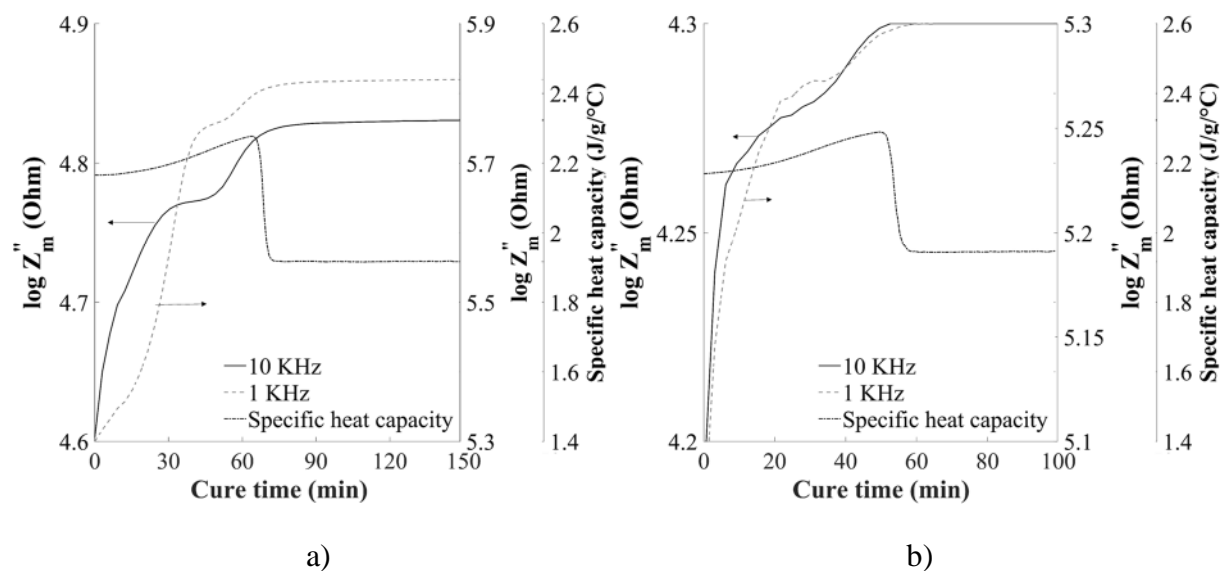

Figure 14 Imaginary impedance evolution at fixed frequencies and comparison with the evolution of specific heat capacity for the isothermal cure of neat RTM6 at a) 150 °C and; b) 160 °C.

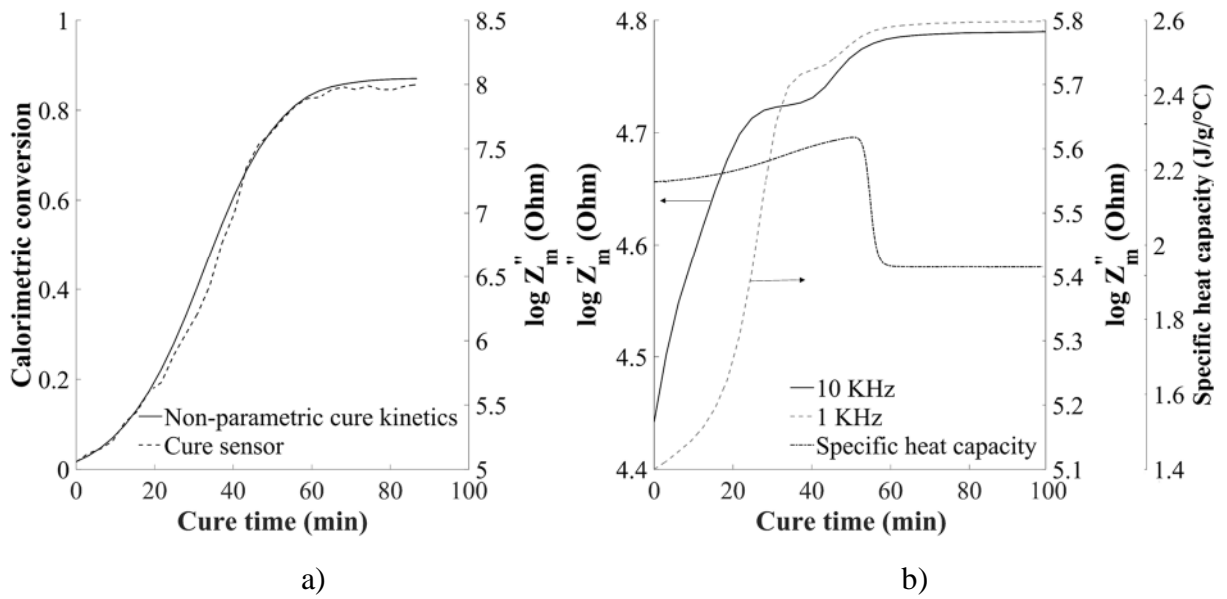

Figure 15 VARTM curing of carbon fibre preform: a) material impedance maximum evolution and comparison with fractional conversion computed using non-parametric kinetics; b) imaginary impedance evolution at fixed frequencies and comparison with the evolution of specific heat capacity.

A novel dielectric sensor for process monitoring of carbon fibre composites manufacturing

Tifkitsis, Konstantinos

2019-05-13

Attribution 4.0 International

Tifkitsis K, Skordos AA. (2019) A novel dielectric sensor for process monitoring of carbon fibre composites manufacturing. *Composites Part A: Applied Science and Manufacturing*, Volume 123, August 2019, pp. 180-189

<https://doi.org/10.1016/j.compositesa.2019.05.014>

Downloaded from CERES Research Repository, Cranfield University