

Directional Drilling Attitude Control With Input Disturbances and Feedback Delay^{*}

Isonguyo J. Inyang^{*} James F. Whidborne^{*}
Martin T. Bayliss^{**}

^{*} School of Aerospace, Transport and Manufacturing, Cranfield University, Bedfordshire, MK43 0AL, UK (e-mail: i.inyang@cranfield.ac.uk, j.f.whidborne@cranfield.ac.uk).

^{**} Schlumberger Oilfield UK Plc, Stonehouse Technology Centre, Brunel Way, Stroudwater Business Park, Stonehouse, Gloucestershire, GL10 3SX, UK (e-mail: mbayliss@slb.com).

Abstract: This paper presents a general approach for the attitude control of directional drilling tools for the oil and gas industry. It extends the recent work where a kinematic bilinear model of the directional drilling tool was developed and used as the basis for Constant Build Rate (CBR) controller design. The CBR controller in combination with a modified Smith Predictor (SP) is implemented for the attitude control of the directional drilling. The results of a transient simulation of the proposed modified SP-CBR controller are presented and compared with that from the CBR controller of the earlier studies. It is shown that the modified SP-CBR controller significantly reduces the adverse effects of input disturbances and time delay on the feedback measurements with respect to stability and performance.

Keywords: Directional Drilling, Attitude Control, Bilinear, Feedback Delay, Input Disturbances

1. INTRODUCTION

In the oil and gas industry, geometric boreholes (i.e. non-vertical, shaped boreholes) are produced by the process of directional drilling. This involves steering a drilling tool in a desired direction along a path defined by a team of reservoir engineers, drilling engineers, geosteers and geologists. Most wells drilled nowadays are horizontal wells, which consist of a vertical part, a curved part known as a build section, and a horizontal section which is steered with respect to geological features in order to maximize oil recovery from a reservoir (Williams, 2010; Shengzong et al., 1999; Li et al., 2009). The technology which enables the steering of the drill allows for turn radii as low as 120 metres (15°/100 ft), enabling complex three dimensional wells to be drilled. Directional drilling can be achieved by either Rotary Steerable Systems (RSS) (Baker, 2001; Tetsuo et al., 2002) and conventional slide directional drilling approaches (Baker, 2001; Kuwana et al., 1994).

For the case of RSS directional drilling tools the Bottom Hole Assembly (BHA) lies inside the borehole and is connected to the surface by a series of steel tubular pipes collectively referred to as the drill string. A schematic of the main RSS directional drilling system components is shown in Fig. 1. The drill string runs all the way to the derrick at the surface where it is suspended by a cable, and rotated by a top-drive which provides torque to the bit, hence the drill string and BHA can be viewed as a propeller shaft delivering torque to the bit directly. Slide directional drilling is similar except the torque to drive the bit is generated downhole by a mud motor (Moyno motor)

^{*} This work was supported by Schlumberger.

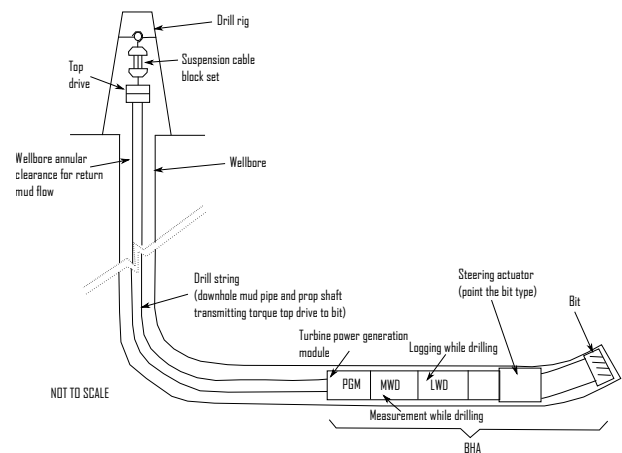

Fig. 1. Schematic of main RSS directional drilling system components

where most of the drill string and BHA is non-rotating relative to the formation. The BHA is the active part of the directional drilling system and is made up of subsystems or “subs” from the bit back to the first drill pipe of the drill string. The subs that constitute the BHA are configured to suit the well plan and drilling objectives but will always include a steering unit which will either be push or point the bit (Panchal et al., 2010; Bayliss et al., 2015; Inyang et al., 2016) to propagate the borehole. The subs include items such as a Power Generation Module (PGM), Measurement While Drilling (MWD) sub, Logging While Drilling (LWD) sub, and steering unit (which includes the toolface actuator and bit).

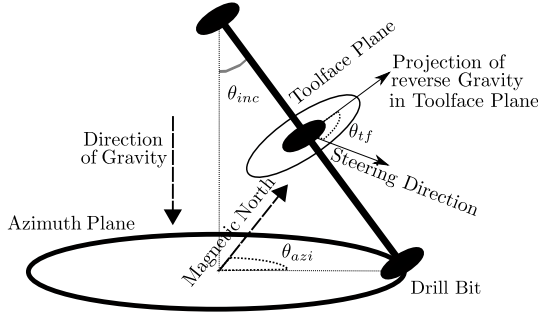

Fig. 2. Conventional attitude and steering parameters for a BHA

It is common in directional drilling to have an outer attitude control loop which generates set point toolface commands (either automatically or manually by the operator in the loop who is known as the “directional driller”) which are passed to an inner loop that controls the steering unit. For the outer attitude control loop the attitude sensor set consists of one triaxis set of accelerometer and one triaxis set of magnetometer transducers, both arranged with the same orientation and sign convention. All six transducer signals are then used to evaluate the orientation azimuth θ_{azi} and inclination θ_{inc} (see Fig. 2) of the MWD, which is mechanically continuous with the steering unit. In this paper, the tool and global coordinate systems are right handed coordinate systems with the x -axis pointing down-hole towards the bit and pointing down, respectively.

However, for measuring the actuator toolface for the inner actuator toolface control loop, it is only necessary to use either the radial magnetometer or accelerometer signals where, in this context, the actuator toolface is defined to be the angular position of the resultant force applied by the steering unit onto the formation. The angular position toolface of the resultant force is measured relative to the projection of the magnetic or gravitational field vector onto a plane at right angles to the BHA. The angular position for the former is known as the Magnetic Toolface (MTF) whereas the latter is known as the Gravity Toolface (GTF) (see Fig. 2).

It is common to define a well plan as a series of GTF values since they are easier to visualize for the directional driller (up is 0° GTF, down is 180° GTF, right is 90° GTF and left is 270° GTF). In practice the MWD sub used for attitude measurement is, by necessity, located some distance (sometimes several tens of feet) back from the steering unit for which the attitude measurement is being made. This introduces a significant measurement delay in the attitude feedback measurement which any outer attitude control loop should be robust enough to deal with in terms of stability and performance. Additionally, there can be a significant dynamic response between the applied toolface from the actuator and the response toolface of the steering unit.

In this paper, the attitude measurement and toolface actuation are not analyzed in detail but the preceding discussion has been included to put the subsequent work into a directional drilling context.

The objective for the directional drilling attitude control system is to hold an attitude specified by inclination

and azimuth angle set points (Genevois et al., 2003). The inclination θ_{inc} and azimuth θ_{azi} angles are shown in Fig. 2. These set-points are communicated to the BHA via low bandwidth (1 – 5 bits per second) mud pulse telemetry. The control strategies recently developed include a hybrid approach consisting of two levels of automation for trajectory control of the tool (Matheus et al., 2014), and a dynamic state-feedback controller design for 3D directional drilling systems (van de Wouw et al., 2016). The attitude control described in this paper is intended to be general and applicable to both RSS and sliding directional drilling for push or point the bit steering units.

Practically, the directional drilling tool experiences input disturbances and also exhibits a long time delay on the feedback measurements. The Constant Build Rate (CBR) controller, proposed by Panchal et al. (2012), provides good performance for the attitude control of the directional drilling tool but is not robust enough to deal with the input disturbances and the long time delay on the feedback measurements. To handle these input disturbances and lengthy time delay on the feedback measurements with respect to stability and performance, this paper extends the work of Panchal et al. (2012), and proposes the attitude control of directional drilling tool by applying the modified Smith Predictor-CBR (SP-CBR) controller, which is the combination of the modified SP, proposed by Normey-Rico et al. (1997), and CBR controller.

When modelling physical systems, the dynamics are often approximated as being linear models that are obtained by a first order Taylor series approximation of the nonlinear model at a particular point of operation. It is clear that such linear models might be inaccurate over a wider range of operation; hence, bilinear models have been proposed to more accurately describe the nonlinear systems (see Bruni et al. (1974) and Schwarz and Dorissen (1989)). Bilinear models can characterize nonlinear properties more correctly than linear models; hence, broaden the range of adequate performance.

In the next section, a kinematic bilinear model of the directional drilling tool is presented. In Section 3, modified SP-CBR controller is proposed that stabilize the attitude of the directional drilling tool and drive it towards the set point. Section 4 presents details about the implementation of the proposed controller in line with existing convention for the drilling industry, and also some simulation results are presented. Conclusions are given in the last section.

2. KINEMATIC BILINEAR MODEL OF THE DIRECTIONAL DRILLING TOOL

The directional drilling tool is modelled as a rigid rod hinged at one end that has only the rotational motion corresponding to what can be interpreted as pitch and yaw, with the roll motion ignored. The rotation and translation rates are small and the translational kinetic energy is assumed zero. Furthermore, the motion of the tool is constrained by the well and hence, momentum terms are redundant. Hence, the kinematic system representing the time varying response of the tool’s attitude (Wen and Kreutz-Delgado, 1991) can be represented as:

$$\dot{\mathbf{x}} = \boldsymbol{\omega} \times \mathbf{x} \quad (1)$$

where $\mathbf{x} \in \mathbb{R}^3$ is a unit vector representing the tools attitude, $\omega \in \mathbb{R}^3$ is the angular velocity vector parameter (the magnitude of which is referred to here as the “build rate”) and \times denotes the vector product operator. Given an initial value, $\mathbf{x}(0) = x_0$, $\|\mathbf{x}_0\| = 1$, and a control ω , the resulting trajectory, $\mathbf{x}(t)$ lies on the surface of the unit sphere, that is $\|\mathbf{x}(t)\| = 1$ for all t and ω . The kinematic motion is controlled by varying ω via the toolface angle (see Panchal et al. (2012) for details). Note that (1) can be expressed as (Panchal et al., 2012):

$$\dot{\mathbf{x}} = M\mathbf{x} \quad (2)$$

where

$$M = \begin{bmatrix} 0 & -\omega_3 & \omega_2 \\ \omega_3 & 0 & -\omega_1 \\ -\omega_2 & \omega_1 & 0 \end{bmatrix} \quad \text{and} \quad \omega = \begin{bmatrix} \omega_1 \\ \omega_2 \\ \omega_3 \end{bmatrix} \quad (3)$$

Now, a generalized state space representation of a Multiple-Input Multiple-Output (MIMO) bilinear system can be expressed as (Kim and Lim, 2003):

$$\dot{x} = Ax + \left(B + \sum_{i=1}^N x_i M_i \right) u \quad (4)$$

where A, B and M_i are constant matrices of suitable dimensions, $u \in \mathbb{R}^{m \times 1}$ denotes the control vector, $x \in \mathbb{R}^{n \times 1}$ represents the vector of state variables and N denotes the number of expansion terms and augmented states.

Writing (2) as:

$$\dot{\mathbf{x}} = M\mathbf{x} = \begin{bmatrix} 0 & -\omega_3 & \omega_2 \\ \omega_3 & 0 & -\omega_1 \\ -\omega_2 & \omega_1 & 0 \end{bmatrix} \begin{bmatrix} x_1 \\ x_2 \\ x_3 \end{bmatrix} \quad (5)$$

$$\dot{\mathbf{x}} = \begin{bmatrix} -\omega_3 x_2 + \omega_2 x_3 \\ \omega_3 x_1 - \omega_1 x_3 \\ -\omega_2 x_1 + \omega_1 x_2 \end{bmatrix} \quad (6)$$

It is clear that the system can be put in the form of (4) with

$$A = [], B = [], N = 3, u = \omega, x = \mathbf{x} = [x_1, x_2, x_3]^T, \\ M_1 = \begin{bmatrix} 0 & 0 & 0 \\ 0 & 0 & -1 \\ 0 & 1 & 0 \end{bmatrix}, M_2 = \begin{bmatrix} 0 & 0 & 1 \\ 0 & 0 & 0 \\ -1 & 0 & 0 \end{bmatrix} \quad \text{and} \quad M_3 = \begin{bmatrix} 0 & -1 & 0 \\ 1 & 0 & 0 \\ 0 & 0 & 0 \end{bmatrix} \quad (7)$$

The tool is subject to disturbances owing to varying rock formations. In addition, there is a tendency for the tool to drop towards a vertical orientation because of gravity, and a tendency for the tool to drift horizontally. In this paper, these disturbances are modelled as input disturbances, D (see Fig. 3).

3. ATTITUDE CONTROL DESIGN

The proposed modified SP-CBR controller design, shown in Fig. 3, is inspired by Normey-Rico et al. (1997), is a combination of a modified SP and a CBR controller. The modified SP is incorporated to account for the long time delay on the feedback measurements.

3.1 Constant Build Rate Controller

The CBR control law proposed by Panchal et al. (2012) is based on the assumption of a continuously variable build

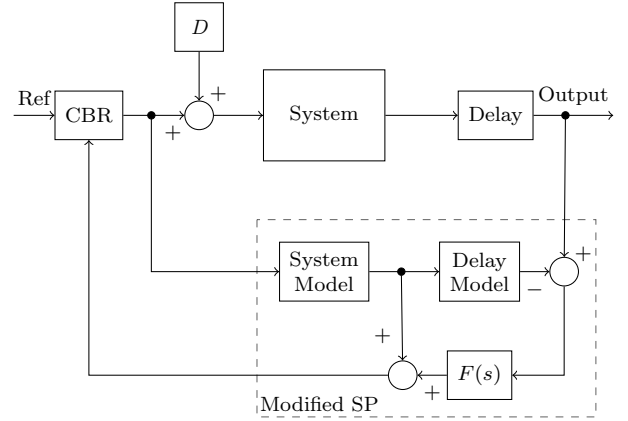

Fig. 3. Modified SP-CBR control scheme

rate is removed and it is assumed that the build rate is constant or zero.

The dynamical system given by (1) with the feedback control law

$$\omega = \begin{cases} K \frac{\mathbf{x} \times \mathbf{x}_d}{\|\mathbf{x} \times \mathbf{x}_d\|} & \text{for } \mathbf{x} \neq \mathbf{x}_d \\ 0 & \text{for } \mathbf{x} = \mathbf{x}_d, \end{cases} \quad (8)$$

is locally asymptotically stable at the equilibrium point $\mathbf{x} = \mathbf{x}_d$ for $\mathbf{x} \in B$ where $\mathbf{x}_d \in \mathbb{R}^3$ is the demand attitude of the tool, K is a constant build rate magnitude, and where

$$B := \{ \mathbf{x} : \|\mathbf{x}\| = 1 \text{ and } \mathbf{x} \in \mathbb{R}^3 \text{ and } \mathbf{x} \neq -\mathbf{x}_d \} \quad (9)$$

The constant build rate magnitude, K is chosen as the maximum possible build rate, which depends on the rate of penetration, V_{rop} and the open-loop curvature of the directional drilling tool, K_{dls} and it is given by

$$K = V_{\text{rop}} \times K_{\text{dls}} \quad (10)$$

The stability of the CBR control law is proved in Panchal et al. (2012) by means of Lyapunov direct method using a lemma that is derived directly from the Lyapunov Theorem of Local Stability (Slotine and Li, 1991).

3.2 Modified Smith Predictor

The modified SP is designed based on the work of Normey-Rico et al. (1997) as shown in Fig. 3, where the system model, delay model and $F(s)$ are implemented. $F(s)$ is denoted as a stable low-pass filter with unitary static gain ($F(0) = 1$). In the work of Normey-Rico et al. (1997), the major drawback of SP proposed by Smith (1959) is highlighted to be poor performance as a result of dead-time uncertainties. These dead time uncertainties are often prevalent in the process industry (including oil and gas industry), and hence the improvement of the robustness of the SP scheme is carried out by the incorporation of the $F(s)$. $F(s)$ is incorporated such that it acts on the difference between the output of the tool and its prediction.

$$F(s) = \frac{1}{T_f s + 1} \quad (11)$$

where T_f is a tuning parameter of $F(s)$. T_f is tuned with the consideration of the trade off between disturbance

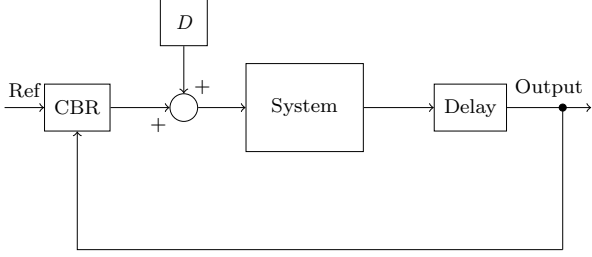

Fig. 4. CBR control scheme

rejection and robustness. As the value of T_f increases, a good robustness characteristics is obtained. Conversely, a poorer disturbance rejection characteristics is obtained as the value of T_f increases (Normey-Rico et al., 1997; Albertos et al., 2015). However, in the absence of disturbances, the closed-loop system nominal performance remains unmodified by the incorporation of $F(s)$. Also, $F(s)$ has no effect on the closed-loop when the system and the system model are equal (Normey-Rico et al., 1997).

The robustness and stability of the modified SP with a linear controller (PI Controller) is presented in Normey-Rico et al. (1997). Interestingly, the modified SP works effectively with a nonlinear controller (CBR controller), and its effectiveness, robustness and stability are shown in the simulation results in the subsequent section.

4. SIMULATION RESULTS

To demonstrate the effectiveness, robustness and stability of the proposed controller, simulations of the proposed modified SP-CBR controller with the dynamics of (1), input disturbances, D and feedback delay are performed based on the modified SP-CBR control scheme shown in Fig. 3. For comparison purposes, the simulation responses from the CBR controller are also provided based on the CBR control scheme shown in Fig. 4. The design parameters and operating point values used for the simulations are listed in Table 1.

The dynamics of the actuator are ignored in the simulations carried out in this paper. The toolface response is subject to lags, however for most tools (though not all) these are generally of a much higher bandwidth than the model kinematics and, as for this paper, can be ignored.

With reference to Figs. 3 and 4, system and system model are both implemented based on (5); while delay and delay model are implemented as $e^{-\tau_d s}$ and $e^{-\tau_m s}$, respectively; where τ_d and τ_m are denoted as time delay and modelled time delay, respectively.

The τ_d is dependent on V_{rop} and the distance of the on tool attitude sensing unit from the tool, d_t and it is given by

$$\tau_d = \frac{d_t}{V_{\text{rop}}} \quad (12)$$

Furthermore, to show the robustness of the proposed modified SP-CBR controller, the predicted measurement delay, τ_m is chosen such that it is not equal to τ_p (see Table 1).

The control output response of the CBR is shown in Fig. 5. The control output response of the CBR exhibits

Table 1. Design Parameters and Operating Point Values

Parameter	Value
V_{rop}	200 ft/hr (1.0158 m/min)
K_{dls}	$8^\circ/100 \text{ ft}$ ($4.5809 \times 10^{-3} \text{ rad/m}$)
d_t	10 ft (3.048 m)
τ_d	3 min
τ_m	1 min
D	$[8.59, 8.59, 8.59] \times 10^{-4} \text{ rad/m}$
T_f	1.5 min
K	$15^\circ/\text{hr}$ ($4.4 \times 10^{-3} \text{ rad/min}$)
Initial Attitude Vector, \mathbf{x}_0	$[0, 1, 0]$
Demand Attitude Vector, \mathbf{x}_d	$[0, \frac{1}{\sqrt{2}}, \frac{1}{\sqrt{2}}]$

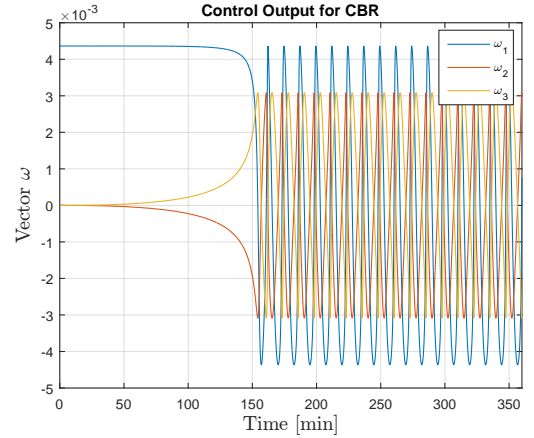

Fig. 5. CBR control output response

oscillatory characteristics about the value of the demand attitude vector as the controller is unable to handle the adverse effects of input disturbances and time delay on the feedback measurements.

The control output response of the modified SP-CBR is shown in Fig. 6. The control output response of the modified SP-CBR exhibits “chattering” behaviour at the value of the demand attitude vector. This “chattering” behaviour is as a result to the fact that, small perturbations on the system cause the control to switch very rapidly about the desired attitude. In practice, the controller is usually implemented in discrete time and the actuator have the dynamics that reduces the “chattering” behaviour. Similar “chattering” behaviour is also evident with sliding mode controllers switching about the sliding manifold (Edwards and Spurgeon, 1998).

The attitude response of the directional drilling tool for the CBR controller is shown in Fig. 7. The CBR attitude response exhibits oscillatory characteristics about the value of the demand attitude vector, due to the adverse effects of input disturbances and time delay on the feedback measurements.

The attitude response of the directional drilling tool for the modified SP-CBR controller is shown in Fig. 8. The modified SP-CBR attitude response converges at the value of the demand attitude vector. Therefore, the proposed modified SP-CBR controller significantly reduces the adverse effects of input disturbances and time delay on the feedback measurements with respect to stability and performance compared with CBR controller.

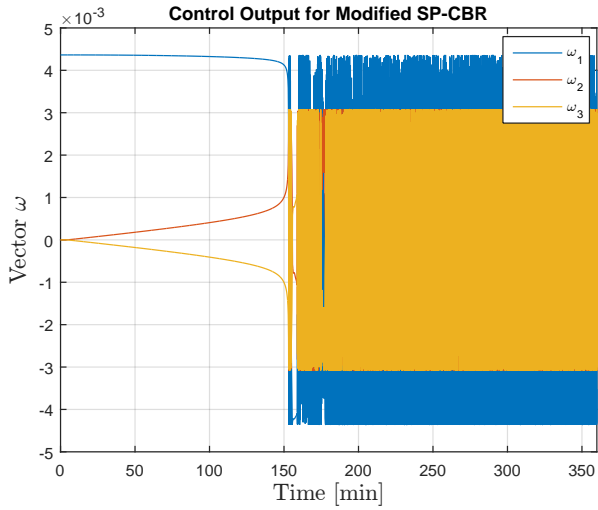

Fig. 6. Modified SP-CBR control output response

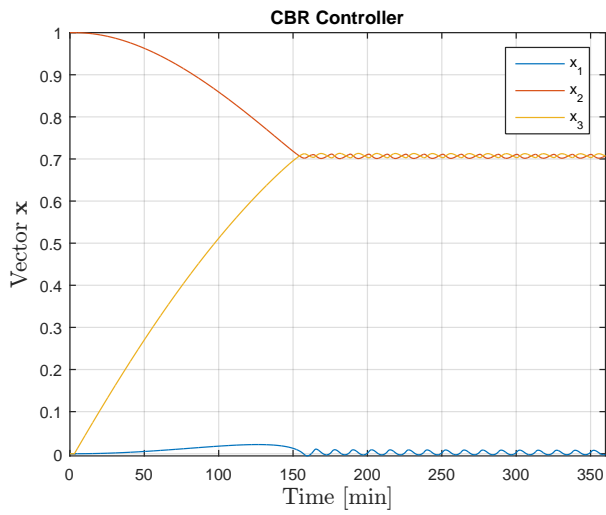

Fig. 7. CBR attitude response

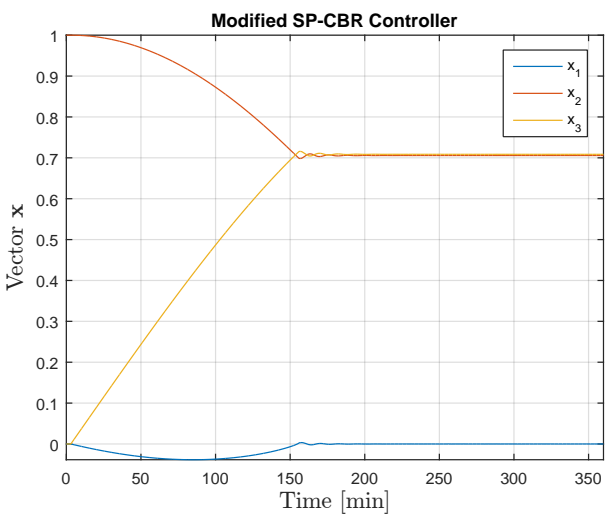

Fig. 8. Modified SP-CBR attitude response

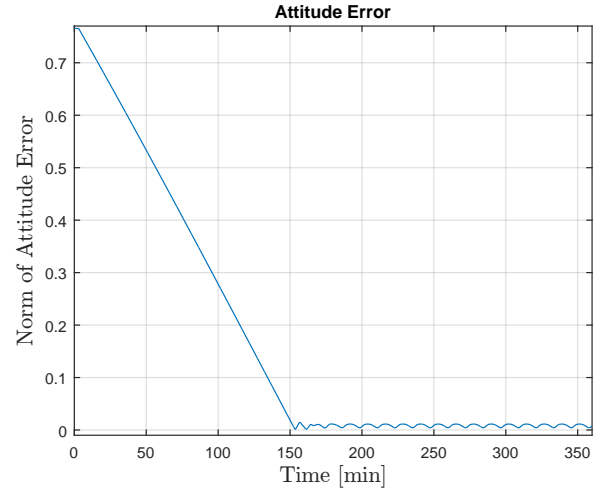

Fig. 9. Norm of attitude error for the CBR controller

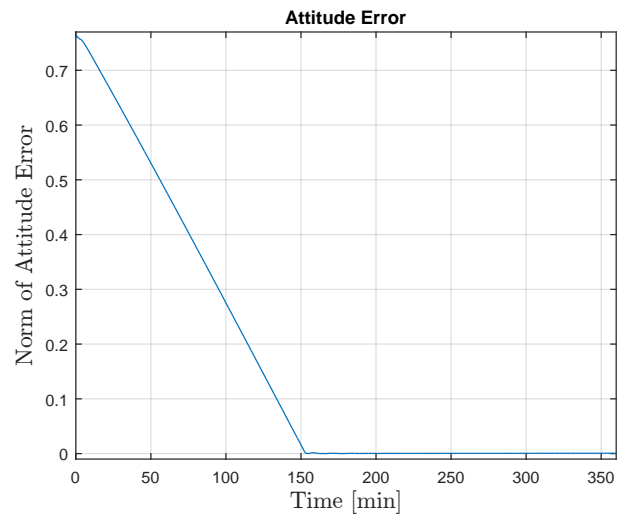

Fig. 10. Norm of attitude error for the modified SP-CBR controller

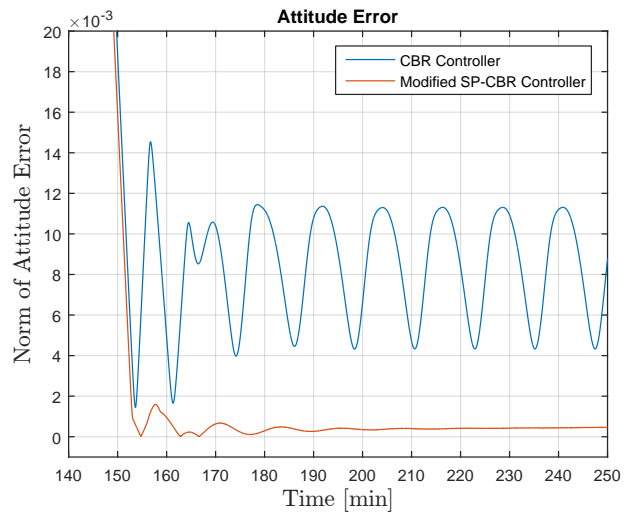

Fig. 11. Norm of attitude error for modified SP-CBR and CBR controllers (detail)

The norm of the attitude error given by $\|\mathbf{x} - \mathbf{x}_d\|$ as a function of time for the CBR controller is shown in Fig. 9. The CBR controller error is unable to converge directly to zero.

The norm of the attitude error given by $\|\mathbf{x} - \mathbf{x}_d\|$ as a function of time for the modified SP-CBR controller is shown in Fig. 10. Detail of the norm of the attitude error for the modified SP-CBR and CBR controllers are shown in Fig. 11. The response of the modified SP-CBR controller is significantly improved compared with that of the CBR controller.

5. CONCLUSIONS

This paper presents a kinematic bilinear model of the directional drilling tool. It proposes a modified SP-CBR controller for the attitude control of the directional drilling tool. The possible beneficial aspects gained by implementing the modified SP-CBR controller include the significant reduction of the adverse effects of input disturbances and time delay on the feedback measurements with respect to stability and performance in the attitude control of the directional drilling tool. In terms of robustness and disturbance rejection, the proposed modified SP-CBR controller is able to handle time delay of 3 min, with up to 66.67% of uncertainty of the modelled time delay, and with input disturbances of $[8.59, 8.59, 8.59] \times 10^{-4}$ rad/m, in the attitude control of the directional drilling tool. The proposed controller needs to be tested by higher fidelity simulations and hard-ware in the loop testing before the controller can be field-tested. Simulations should include actuator and sensor dynamics and uncertainty and testing over the full range of operation. Stability proof of the proposed scheme is an open problem.

ACKNOWLEDGEMENT

The authors are grateful to Schlumberger for the continuous support and permission to publish this paper.

REFERENCES

- Albertos, P., Garcia, P., and Sanz, R. (2015). Control of input/output delayed and disturbed unstable plants. In *20th IEEE International Conference on Methods and Models in Automation and Robotics (MMAR)*. Miedzydroje, Poland.
- Baker, R. (2001). *A Primer of Oilwell Drilling: A Basic Text of Oil and Gas Drilling*. Univ. of Texas at Austin, Petroleum Extension Service, Texas, USA, 6th edition.
- Bayliss, M.T., Inyang, I.J., and Whidborne, J.F. (2015). Application of LQG control to attitude control of directional drilling. In *24th International Conference on Systems Engineering*. Coventry, UK.
- Bruni, C., DiPillo, G., and Koch, G. (1974). Bilinear systems: An appealing class of nearly linear systems in theory and applications. *IEEE Transactions on Automatic Control*, AC-19(4), 334–348.
- Edwards, C. and Spurgeon, C.K. (1998). *Sliding Mode Control Theory and Applications*. Taylor & Francis, London, UK.
- Genevois, J., Boulet, J., Simon, C., and Reullon, C. (2003). Gyrostab project: The missing link azimuth and inclination mastered with new principles for standard rotary BHAs. In *SPE/IADC Drilling Conference*. Amsterdam, Netherlands.
- Inyang, I.J., Whidborne, J.F., and Bayliss, M.T. (2016). Bilinear modelling and bilinear PI control of directional drilling. In *11th UKACC International Conference on Control*. Belfast, UK.
- Kim, B. and Lim, M. (2003). Robust H_∞ control method for bilinear systems. *Int. J. of Control, Automation and Systems*, 1(2), 171–177.
- Kuwana, S., Kiyosawa, Y., and Ikeda, A. (1994). Attitude control device and drilling-direction control device.
- Li, A., Feng, E., and Gong, Z. (2009). An optimal control model and algorithm for the deviated well's trajectory planning. *Applied Mathematical Modelling*, 33(7), 3068–3075.
- Matheus, J., Ignova, M., and Hornblower, P. (2014). A hybrid approach to closed-loop directional drilling control using rotary steerable systems. In *SPE Latin American and Caribbean Petroleum Engineering Conference*. Maracaibo, Venezuela.
- Normey-Rico, J.E., Bordons, C., and Camacho, E.F. (1997). Improving the robustness of dead-time compensating PI controllers. *Control Engineering Practice*, 5(6), 801–810.
- Panchal, N., Bayliss, M.T., and Whidborne, J.F. (2010). Robust linear feedback control of attitude for directional drilling tools. In *13th IFAC Symposium on Automation in Mining, Mineral and Metal Processing*. Cape Town, South Africa.
- Panchal, N., Bayliss, M.T., and Whidborne, J.F. (2012). Attitude control system for directional drilling bottom hole assemblies. *IET Control Theory and Applications*, 6, 884–892.
- Schwarz, H. and Dorissen, H.T. (1989). System identification of bilinear systems via realization theory and its application. *Control, Theory and Advanced Technology*, 5(2), 137–155.
- Shengzong, J., Xilu, W., Limin, C., and Kunfang, L. (1999). A new method for designing 3D trajectory in sidetracking horizontal wells under multi-constraints. In *SPE Asia Pacific Improved Oil Recovery Conference*. Kuala Lumpur, Malaysia.
- Slotine, J.J.E. and Li, W. (1991). *Applied Nonlinear Control*. Prentice Hall, Englewood Cliffs, NJ, USA.
- Smith, O. (1959). A controller to overcome dead time. *ISA Journal*, 6(2), 28–33.
- Tetsuo, Y., Cargill, E., Gaynor, T., Hardin, J., Hay, R., Akio, I., and Kiyosawa, Y. (2002). Robotic controlled drilling: A new rotary steerable drilling system for the oil and gas industry. In *IADC/SPE Drilling Conference*. Texas, USA.
- van de Wouw, N., Monsieurs, F.H.A., and Detournay, E. (2016). Dynamic state-feedback control of nonlinear three-dimensional directional drilling systems. *IFAC-PapersOnLine*, 49(18), 85–90.
- Wen, J.T. and Kreutz-Delgado, K. (1991). The attitude control problem. *IEEE Transactions on Automatic Control*, 36(10), 1148–1162.
- Williams, S. (2010). Geosteering: Where are we? Where are we going. In *EAGE Geosteering and Well Placement Workshop: Balancing Value and Risk*. Dubai, UAE.

Directional drilling attitude control with input disturbances and feedback delay

Inyang, Isonguyo J.

2017-10-18

Attribution-NonCommercial-NoDerivatives 4.0 International

Isonguyo J. Inyang, James F. Whidborne, Martin T. Bayliss. Directional drilling attitude control with input disturbances and feedback delay. IFAC-PapersOnLine, Volume 50, Issue 1, July 2017, Pages 1409-1414

<https://doi.org/10.1016/j.ifacol.2017.08.246>

Downloaded from CERES Research Repository, Cranfield University