

GeoSAR
Summary of the Group Design Project
MSc in Astronautics and Space Engineering 2005/06
Cranfield University

College of Aeronautics Report 0509

ISBN 1861941242

Dr. Stephen Hobbs
Cranfield Space Research Centre
School of Engineering
Cranfield University
Cranfield
Bedford MK43 0AL UK
s.e.hobbs@cranfield.ac.uk

14 August 2006

Abstract

Students of the MSc course in Astronautics and Space Engineering 2005/06 at Cranfield University took GeoSAR as one of their group projects. This report summarises their findings.

GeoSAR is an initial feasibility study for a satellite carrying a passive bistatic radar receiver based in geosynchronous orbit. The feasibility of the radar concept has already been established (e.g. through the work of Prati et al. of Politecnico di Milano) but no designs have yet been published for a satellite to support the mission. This project develops an outline design of the spacecraft and confirms its feasibility within a (conservative) mass budget of approximately 300 kg. Mission drivers are the radar antenna diameter and the station-keeping propulsion required for a design life of 15 years. Technologies such as inflatable structures and (field-emission) electric propulsion are used to reduce the spacecraft's mass.

An outline cost estimate for the mission suggests that a GeoSAR mission would be significantly cheaper than conventional low-Earth orbit radar satellites to achieve similar capability in terms of rapid-response imaging and interferometry. In several areas the GeoSAR design is conservative and it is plausible that on further iterations of the design the cost and mass can be reduced. This suggests that among options for future Earth observation missions, GeoSAR deserves serious consideration.

ISBN 1861941242

This report is available electronically from Cranfield University's QUEprints service (<https://dspace.lib.cranfield.ac.uk/>).

Copyright Cranfield University 2006. All rights reserved. No part of this publication may be reproduced without the written permission of the copyright holder.

Acknowledgements

The project is very much a team effort, and contributions from all those involved are much appreciated.

First of all, the work presented is primarily that of the MSc students (Steve Allen, Emily Brownbill, Jan Butynski, Martin Gavin, Warren Hamilton, Steve Jefferys, Mathieu Lesieur, James Marshall, Frederic Wanat), who each have contributed about 600 hours. The background technical work has been supported by Davide Bruno (doctoral researcher at Cranfield University).

Other Cranfield Space Research Centre staff (Dr Jenny Roberts, Dr Peter Roberts, Tom Bowling, Dr Jenny Kingston) have helped direct the project and advise students. Experts from the space industry around the world have also supported the project by providing information and guidance in response to questions from the team. Their time and encouragement is much appreciated.

Contents

Contents	iii
List of figures	v
List of tables	vi
1 Introduction	1
1.1 Organisation of the Project	2
1.2 The Project's Starting Point	2
1.3 Assumptions / Constraints	2
1.4 Organisation of this Report	3
2 Technical Summary of GeoSAR	5
2.1 Initial Baseline and Constraints	7
2.1.1 Mission cost baseline	7
2.2 System	9
2.2.1 Budgets [1]	9
2.2.2 Operations [2]	10
2.3 Mechanical	11
2.3.1 Antenna [3]	11
2.3.2 Configuration [4]	11
2.3.3 Spacecraft [5]	12
2.4 Electrical power, Communications, Data Handling	12
2.4.1 Power [6]	12
2.4.2 Communications [6]	12
2.4.3 Data Handling	13
2.5 Payload	13
2.6 Launch and Orbits	14
2.7 Propulsion and AOCS	15
3 Conclusions	17
3.1 Future Work	17
References	20
A Organisation of the Project	21
B Individual Report Executive Summaries	23
B.1 Steven Allen: GeoSAR, Mechanical Subsystem	24
B.2 Emily Brownbill: GeoSAR, Systems Engineering	25
B.2.1 Introduction	25
B.2.2 Systems Engineering	25
B.2.3 System Design and Budgets	26
B.2.4 Conclusions and Further work	27
B.2.5 Reference	27

B.3	Jan Butynski, Mission Analysis: Launch and Orbit Raising	28
	B.3.1 Launch Vehicle Selection	28
	B.3.2 The Launch	29
	B.3.3 Attaining the Final Orbit	29
	B.3.4 ΔV Budget	30
B.4	Martin Gavin: GeoSAR AOCS	31
	B.4.1 Introduction	31
	B.4.2 AOCS Requirements	31
	B.4.3 External perturbations	31
	B.4.4 Rotational actuators	32
	B.4.5 Translational Actuators	32
	B.4.6 Conclusions	33
	B.4.7 References	33
B.5	Warren Hamilton: GeoSAR, Operations structure	34
	B.5.1 System summary	34
	B.5.2 Ground system	35
	B.5.3 Failure analysis	35
	B.5.4 Autonomy	36
B.6	Steve Jefferys: GeoSAR, Mission Analysis	37
	B.6.1 GeoSAR Concept	37
	B.6.2 Orbit Selection	37
	B.6.3 Eclipses	37
	B.6.4 Manoeuvres	38
	B.6.5 Position Finding	38
	B.6.6 Attitude Sensing	39
	B.6.7 Conclusions	39
	B.6.8 References	39
B.7	Mathieu Lesieur: GeoSAR, antennas design	40
	B.7.1 GeoSAR Antenna Definition	40
	B.7.2 Rigidization Process	41
	B.7.3 Finite Element Analyses	41
	B.7.4 Inflation System Determination and Sizing	42
	B.7.5 References	42
B.8	Alex Lucas	43
	B.8.1 Introduction	43
	B.8.2 Choice of application	43
	B.8.3 Spatial and temporal requirements	43
	B.8.4 Payload sizing and simulation	44
	B.8.5 Conclusion	45
	B.8.6 References	45
B.9	James Marshall	46
	B.9.1 Introduction	46
	B.9.2 The Electrical Power system	46
	B.9.3 Power system requirements	46
	B.9.4 Solar panels	47
	B.9.5 Batteries	48
	B.9.6 Link budget	48
	B.9.7 Conclusion	48
	B.9.8 References	48
B.10	Frederic Wanat: GeoSAR Mechanical Subsystem	49
	B.10.1 Introduction	49
	B.10.2 Choice of the antenna	49
	B.10.3 Configuration	50
	B.10.4 References	51

List of Figures

1.1	General configuration of the GeoSAR spacecraft	1
2.1	GeoSAR system architecture	5
2.2	Soil moisture variation with time from the Soja90 experiment (courtesy of Dr. Albert Oliosio, INRA, Avignon).	6
2.3	Geometry of the relation between aperture size and resolution at the surface. Angular resolution θ is approximately equal to wavelength (λ) divided by aperture diameter (d), and also to resolution (l) divided by range (h).	7
2.4	Example link budget gain contours	8
2.5	Contours of constant slant path range	9
B.1	Reaction Wheel Configuration	32
B.2	Final constellation selected for GeoSAR.	37
B.3	Results from STK simulation of GeoSAR eclipses over 1 year.	38
B.4	Description of the inflatable antenna proposed for GeoSAR.	40
B.5	FE models of the GeoSAR antenna.	42
B.6	Overview of possible SAR applications.	44
B.7	Picture of L'Garde's 500 W solar arrays once inflated [L'Garde, 2003].	47
B.8	Graph shows specific energy vs. power density for some secondary batteries types [Lindon, 2002].	48
B.9	GeoSAR components	50
B.10	GeoSAR spacecraft stowed and deployed configurations.	51

List of Tables

2.1	Relative strengths and weaknesses of LEO and GEO orbits for radar imaging of the Earth.	6
2.2	Key GeoSAR mission baseline parameters and constraints. Several of these are based on the concept used by Prati et al. [7].	7
2.3	Costs of recent civil LEO radar spacecraft	8
2.4	Typical mass fractions quoted in [8, Table 10.10, p 316].	10
2.5	GeoSAR mass budget for an individual spacecraft	10
2.6	Estimated costs for a GeoSAR mission (design, manufacture, launch, 15 yr operations) [1].	10
2.7	Antenna technologies considered for GeoSAR	11
2.8	GeoSAR mass properties [9, p 7]	12
2.9	GeoSAR electrical power requirements	13
2.10	GeoSAR electrical power requirements in eclipse	14
2.11	Hydrazine thruster requirements	14
2.12	GeoSAR orbit parameters	15
2.13	GeoSAR orbit control requirements	15
A.1	GeoSAR work package breakdown and allocation.	21
B.1	Sub-system responsibilities for each student	23
B.2	GEO, LEO Cost Comparison	26
B.3	System Mass Budget	26
B.4	Subsystem Dry Mass	26
B.5	GEO, LEO Cost Comparison	27
B.6	The trade-off between the six most appropriate LV's	28
B.7	GeoSAR AOCS Requirements	31
B.8	Magnitude and Nature of External Perturbations on GeoSAR	31
B.9	Station keeping and Orbit acquisition actuator shortlist	33
B.10	Station Keeping actuator trade-off	33
B.11	Position finding technology trade-off	38
B.12	GeoSAR antenna mean characteristics	40
B.13	GeoSAR payload objectives	45

Chapter 1

Introduction

GeoSAR is the topic of the one of the two group projects for the 2005/06 year of the MSc in Astronautics and Space Engineering at Cranfield University.

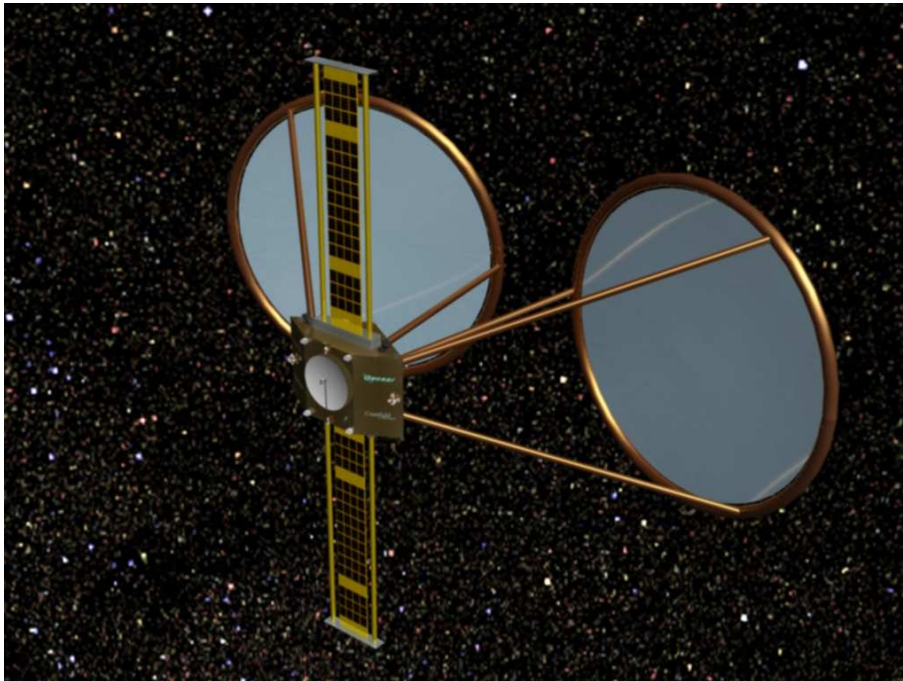

Figure 1.1: General configuration of the GeoSAR spacecraft. Note the two large (6 m diameter) Earth-pointing radar antennas and the solar arrays which rotate about their axis to face the Sun.

This report is a summary of the project, and is based on the reports written by students describing their individual project responsibilities. The full reports are available from the School of Engineering, Cranfield University, and are summarised in Appendix B. *Readers should note that although gross errors in the individual reports should have been corrected, minor inconsistencies may remain in the detailed technical work presented.*

GeoSAR is a mission study for a satellite carrying a radar payload in geosynchronous (GEO) orbit. The radar uses the synthetic aperture radar (SAR) technique to achieve a useful spatial resolution at the Earth's surface despite the long range, and is passive so there is no need for a high-power transmitter on the satellite (Prati et al. [7] describe the radar principles for this concept). A significant advantage of a geosynchronous radar over more conventional low-Earth orbit (LEO) radars is that almost continuous imaging is possible. Orbit dynamics require that a single LEO radar with global coverage will not pass over the same point on the Earth's surface at intervals shorter than about a week, whereas a GEO radar could obtain images every few hours.

For applications such as soil moisture measurement or disaster response this difference could be crucial.

Although the radar principles have been confirmed, there have been no published studies of the spacecraft design required for a GeoSAR mission. This project is a feasibility study of the design of the spacecraft.

1.1 Organisation of the Project

The project runs over the first two terms (October to Easter) of the year long MSc course in Astronautics and Space Engineering at Cranfield University. The students work as one team, organised as several subgroups, and each student contributes about 600 hours' effort to the project; the total resource represented by the project is approximately 6000 hours' work (or 3-4 man-years) for the academic year 2005/06.

Appendix A lists the students involved in GeoSAR and shows their responsibilities in the project. The whole team met weekly to share progress and make key decisions about the mission design. Students in each of the sub-groups also met between the main meetings as they worked on their individual responsibilities - with the system engineers working hard to coordinate all the separate tasks.

The main project milestones were presentations in December and March. In December, an initial mission baseline was presented as a summary of the system design achieved during the first term. Following this, more detailed sub-system design was performed and the system baseline was refined before the final project presentation in March 2006. This report includes some minor additional work prepared for the open presentation on the GeoSAR project in May 2006.

1.2 The Project's Starting Point

The starting point offered to the GeoSAR team was based on the Prati et al. concept, and consisted of a constellation of several spacecraft in GEO to provide daily (or more frequent) images of the Earth's surface. The challenge was to develop a mission design which was (highly) competitive with achieving the same imaging performance using conventional LEO technology.

Several areas were suggested for initial attention:

- the number of spacecraft to use: more spacecraft means more redundancy but, probably, increased system cost,
- the antenna technology: a lightweight antenna is needed, and several competing technologies exist (Astromesh, inflatables, deployable),
- the operational concept: i.e. consider potential applications and how images should be acquired to satisfy them.

There were important trade-offs however in all project areas which have contributed to the final solution developed.

1.3 Assumptions / Constraints

The radar concept outlined by Prati et al. [7] is taken as a baseline. In this project we have assumed that this is broadly correct and that the signal processing necessary to form images can be implemented (although it is not trivial): experimental validations of the concept have been performed by other groups. We do not consider details of the radar imaging or beam forming, but have focussed instead on the space engineering required to design, build and operate the spacecraft.

Particular assumptions we have made or constraints we have adopted are:

- Radar concept based closely on Prati et al. [7]. The concept is credible and allows a passive radar to image from GEO.

- We assume that a convenient broadcast transmitter is available to illuminate wherever we want to image.
- We assume that the necessary geostationary orbit slots are available where necessary (and at no cost to the project!).
- Geosynchronous (GEO) orbit. The excellent temporal resolution available from GEO is a key strength of the GeoSAR concept.
- Spacecraft lifetime of approximately 15 years. Since many GEO missions are designed for this lifetime, existing expertise and hardware can be re-used for GeoSAR, thus lowering costs.
- A “low-cost” mission is required. For a realistic project it is important that costs are minimised - the costing benchmark is the cost of achieving the same performance using conventional LEO technology.

The level of technology assumed is that currently available or reasonably likely to become available in the next few years.

1.4 Organisation of this Report

Following this Introduction, Chapter 2 gives an overview of the technical work performed by the students and summarises their findings (e.g. tables for the mass, power, cost and propulsion budgets). This chapter also serves as an overview of the constraints the design had to meet. Chapter 3 is a brief discussion of the the project’s findings with some suggestions for further work. The main content of the report is Appendix B where Executive Summaries from each student’s report are presented.

Chapter 2

Technical Summary of GeoSAR

GeoSAR is in a geosynchronous orbit and uses reflected broadcast signals (TV or digital radio) to form radar images. The radar system is bi-static since the transmitter and receiver are at different locations. Aperture synthesis is used so that a useful spatial resolution at the Earth's surface can be achieved: this means that either the transmitter or the receiver must move (by several tens of km). Figure 2.1 is an outline diagram of the system. Spacecraft A is the broadcast satellite transmitting TV or radio signals over a wide area. The GeoSAR spacecraft (B) collects reflected signals from an area of the broadcast zone and immediately re-transmits these down to a ground station (C) which also has received broadcast signals directly. The signal processing to form the image can take place at the ground station, so that the GeoSAR satellite does not need high computing power on-board.

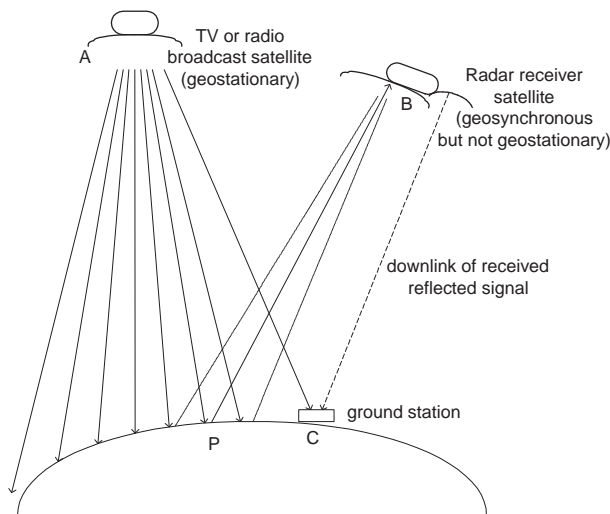

Figure 2.1: GeoSAR system architecture. A GeoSAR spacecraft collects reflected broadcast signals and re-transmits them directly to a control station on the ground which has also received the broadcast signals directly. Signal processing to create the image takes place on the ground.

This passive bi-static radar concept has been demonstrated several times, and Prati et al. [7] describe a system where both the transmitter and receiver are in geo-synchronous orbit. For imaging Earth's surface a radar in geo-synchronous orbit has an important advantage over low-Earth orbit (LEO) radar satellites: the satellite can have a continuous view over continental areas whereas LEO satellites are typically in orbits which only allow repeat images to be taken every few days (or even weeks).

The high temporal resolution possible with GeoSAR (an image every few hours) allows processes to be observed which are currently undetected. An example of this is illustrated by Figure 2.2 which shows how soil moisture varies rapidly with time: the sharp variations on timescales less

than a few days are clearly sometimes significant. A system unable to see these rapid changes is unlikely to measure soil moisture effectively, and so one possible important application of GeoSAR could be improved soil moisture monitoring over continental areas. Another potentially important application is mapping in support of disaster relief. Radar is an all-weather, day/night imaging method and combining this with the rapid response means that in principle GeoSAR could provide images within hours of a disaster such as an earthquake or volcanic eruption.

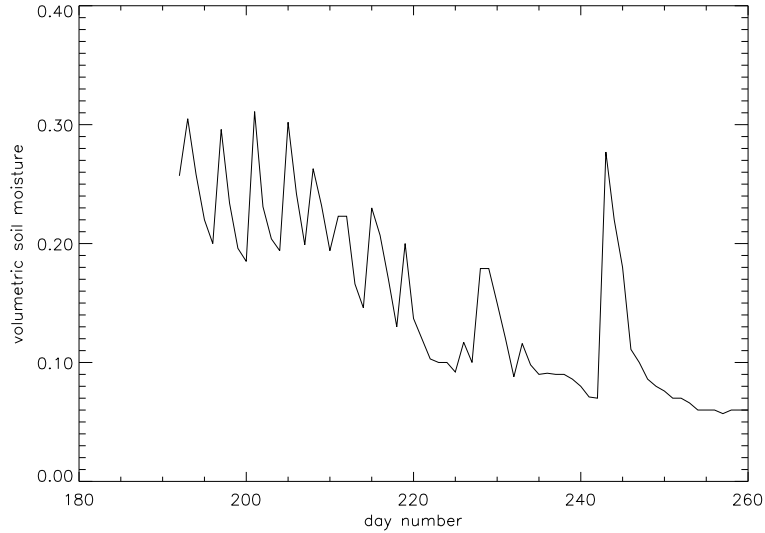

Figure 2.2: Soil moisture variation with time from the Soja90 experiment (courtesy of Dr. Albert Oliosio, INRA, Avignon).

Table 2.1: Relative strengths and weaknesses of LEO and GEO orbits for radar imaging of the Earth.

Orbit	Advantages	Disadvantages
LEO	Strong signal Fine resolution	Poor temporal repeat
GEO	Good temporal resolution	Weak signals Moderate resolution

The resolution and the size of the region being imaged are determined mainly by diffraction limits (see Figure 2.3). The diffraction-limited angular resolution (θ) of a circular aperture of diameter d with wavelength λ is $\theta = 1.2\lambda/d$. This angle (based on the *real* aperture size) multiplied by the range from the aperture to the target gives the size of the area being imaged. A 6 m aperture operating at L-band ($\lambda = 0.2$ m) in GEO (slant range 40 000 km) has a footprint about 1600 km across. Using the relationship to deduce the aperture size from the resolution, range and wavelength, gives that to achieve 100 m resolution the size of the *synthesised* aperture must be at least 80 km.

Figures 2.4 and 2.5 illustrate other aspects of the GeoSAR imaging principles.

Figure 2.4 shows the contours of equal sensitivity defining the system’s footprint size on the ground for a single spot beam. GeoSAR uses a set of 15 contiguous spot beams for each of its two antennas, so that a single spacecraft can view practically all the area either north or south of the equator in view from GEO, and two spacecraft can view the whole of the disk.

Figure 2.5 shows contours of equal range for a transmitter at 20° E and receiver at 20° W (both spacecraft at GEO orbit on the equator). For ground locations near the equator, ranging gives good resolution in the East-West direction and so the synthetic aperture must give the North-South resolution (i.e. be oriented North-South), while at high latitudes ranging gives North-South resolution and the synthesised aperture must give the East-West resolution (i.e. be oriented East-West). To allow imaging at all latitudes, the orbit of the receiver (relative to the rotating Earth)

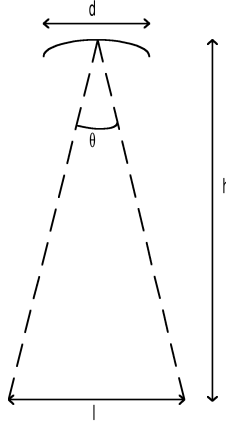

Figure 2.3: Geometry of the relation between aperture size and resolution at the surface. Angular resolution θ is approximately equal to wavelength (λ) divided by aperture diameter (d), and also to resolution (l) divided by range (h).

must have approximately equal dimensions North-South and East-West, and so a circular relative orbit is used.

2.1 Initial Baseline and Constraints

The initial baseline and any constraints are summarised in the Introduction: some of these aspects are quantified in Table 2.2.

Table 2.2: Key GeoSAR mission baseline parameters and constraints. Several of these are based on the concept used by Prati et al. [7].

Parameter	Value
Orbit period	24 hour (geosynchronous)
Range to target	approx. 40 000 km
Transmitter band	L-band ($\lambda = 20$ cm)
Transmitter bandwidth	4 MHz (per polarisation)
Spot beam footprint diameter	1600 km
Integration period for imaging	8 hr
Spatial resolution achieved	100 m (nominal)

2.1.1 Mission cost baseline

The conventional baseline against which the GeoSAR concept will be compared is based on existing LEO radar satellites. A radar system capable of interferometrically imaging a given area daily could be formed by flying several “conventional” LEO radar satellites in a constellation. The costs of a conventional LEO radar system are estimated as follows.

In LEO, the satellite makes 14-15 orbits of Earth each day. Since the circumference of the equator is 40 000 km, the gap between adjacent (descending) crossings is $40\,000 / 14 = 2857$ km. If each radar can image anywhere within a 500 km swath (typical of current radars), then $2857 / 500 = 5.7 \sim 6$ satellites are needed to ensure daily interferometric imaging (no redundancy). Costs of recent LEO radar satellites are given in Table 2.3.

Assuming some cost savings from building several spacecraft of the same design, a typical unit cost can be taken as € 300M. Although this system delivers broadly similar capability (daily interferometric imaging), its performance differs in several important respects:

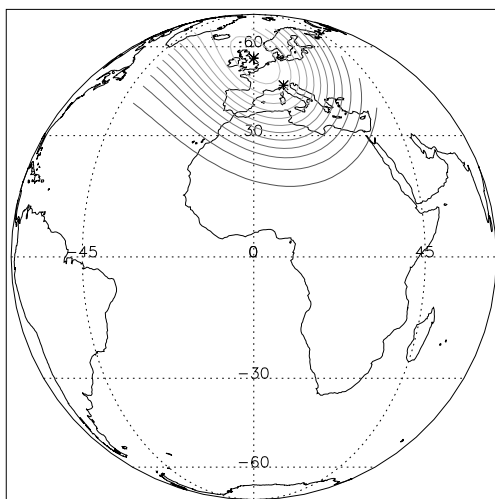

Figure 2.4: Contours of constant link budget gain for a single spot beam between a transmitter (at 20° E) and receiver (at 20° W) antennas. The transmitter beam is broad and centered in northern Europe. The receiver beam is narrower and centred near the UK.

Table 2.3: Costs of recent civil LEO radar spacecraft. These are approximate figures - it is not clear exactly what payload is included in the figures, and it is likely that these ignore the launch costs. (Assumed $\$Can 1 = \text{€ } 0.71$)

Satellite	Cost / €M	Comments
ERS-1	800[10]	Cost includes spacecraft and radar payload, but not the AO (announcement of opportunity) payloads.
ERS-2	550[10]	Copy of ERS-1 with just 1 extra sensor.
Envisat	1450[10]	Very large s/c, many other sensors apart from radar
Radarsat-1	477[11]	Reported cost to Canadian Government of $\$Can$ 672 M
Radarsat-2	296+[11]	Reported cost to Canadian Government of $\$Can$ 417.4 M Government pays for data; industry pays for and develops the s/c.

- Mission lifetime: LEO design life is 3-5 yr, possibly achieving 7 yr; so for the system to achieve a typical geostationary comsat lifetime of 15 yr, 2-3 times as many spacecraft will be needed.
- The LEO constellation provides global coverage at a resolution of 10 m: this is much better than the alternative GeoSAR concept. Note however that this implies significantly more ($\sim \times 100$) data to transmit, process and archive, and the highest resolution cannot be achieved during one pass across the full 500 km swath.
- Operations of the LEO s/c are likely to be more complex because of the greater orbit perturbations, the need to hand-over between s/c, and the data handling (store and forward architecture because it will not be possible to have ground stations covering the globe).
- The LEO constellation is not as flexible since the orbits dictate the coverage pattern, and changing orbits is expensive in terms of fuel use. GeoSAR could provide repeat images at intervals of less than a day.
- Orbit maintenance for the LEO s/c will be more expensive (fuel use and complexity) because there are more perturbations in LEO than GEO and because the imaging geometry imposes more severe constraints to allow interferometry on the LEO orbit than GEO.

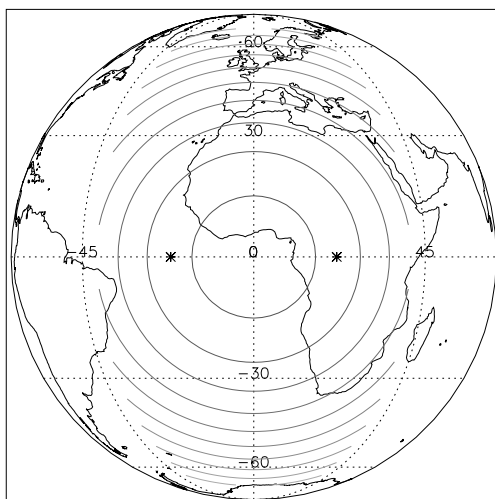

Figure 2.5: Contours of constant slant path range between the transmitter (at 20° E) and receiver (at 20° W) spacecraft.

Allowing for a total of 15 LEO spacecraft to be built for a 15 yr lifetime (mean life of 6 yr) gives a baseline equivalent LEO system cost of $\text{€ } 300\text{M} \times 15 = \text{€ } 4500\text{M}$. This is clearly only an approximate costing, but it does give a figure which can be used to assess the value provided by a GeoSAR system. If a credible GeoSAR system can be produced for significantly less than this but offering comparable performance then the concept is worthy of more in-depth consideration.

For GeoSAR to be attractive, it must be much cheaper than $\text{€ } 4.5\text{B}$ for global coverage. (Since GeoSAR cannot image polar regions and has poorer spatial resolution, a benchmark cost of perhaps half this, say $\text{€ } 2\text{B}$, may be more appropriate.)

2.2 System

The system study focussed initially on key system parameters such as the antenna technology, the number of satellites required, and the prime application for GeoSAR. The trade-off used a set of mission scenarios (e.g. a constellation of spacecraft with inflatable antennas providing global coverage for earthquake monitoring) so that the sub-system engineers had a clear understanding of the context for their work for each case. From the analysis of each scenario a baseline mission was selected, and (once refined) this led to the final baseline:

GeoSAR mission baseline: A constellation of 4 spacecraft at each of 3 locations around the geostationary ring to provide global coverage for disaster monitoring and environmental applications. Each spacecraft of mass approximately 300 kg carries two inflatable antennas (6 m diameter) and has 15 spot beams per antenna. The 4 spacecraft at each location are in two circular relative orbits (2 in each ring) of diameters approximately 80 km and 100 km.

Figure 1.1 shows the configuration of a single GeoSAR spacecraft.

2.2.1 Budgets [1]

Tables 2.4 and 2.5 present, respectively, mass fractions for an “average” spacecraft and the mass fractions for the GeoSAR baseline. From these it can be seen that the current design is conservative in terms of the spacecraft mass relative to the payload mass (GeoSAR only achieves 7% relative to a typical 15–50%) so that it seems reasonable to assume that once the design has been iterated it will be possible to reduce the total mass considerably.

Table 2.6 presents an estimate of the GeoSAR mission costs including design, manufacture, launch and operations for 15 years. These indicate that GeoSAR is expected to cost less than a mission based on conventional LEO radars. The main saving is in the unit cost of each satellite:

Table 2.4: Typical mass fractions quoted in [8, Table 10.10, p 316].

Sub-system	Typical mass fraction % of M_{dry}
Payload	15-50
Thermal	2-5
Structure & mechanisms	15-25
<i>Margin</i>	5-25

Table 2.5: GeoSAR mass budget for an individual spacecraft [1]. Notes: (1) Payload includes the downlink and main antennas but no amplifiers. (2) A basic system with 2 omni-directional antennas and amplifiers etc. for telecommand and telemetry is assumed.

Sub-system	Mass kg	Fraction % of M_{dry}	Comments (note)
Payload	21	7	[1, Tables 3.2,3.8] (Note 1)
Power	56	18	[1, Table 3.8]
Communication	10	3	(Note 2)
Data handling	10	3	[1, Table 3.8]
Mechanical	89	29	[1, Table 3.9]
AOCS (excl. fuel)	59	19	[1, Table 3.4]
<i>Margin</i>	61	20	Assumed 20% of M_{dry}
Sub-total (M_{dry})	306	100	Includes margin
Fuel	27		[1, Table 3.4]
Fuel margin	5		Assume 25% of fuel mass
Total	338		

the GeoSAR concept allows smaller, lighter satellites to be used which reduces the spacecraft cost.

Table 2.6: Estimated costs for a GeoSAR mission (design, manufacture, launch, 15 yr operations) [1].

Item	Estimated cost €M
12 GeoSAR satellites	1066
4 launches	172
Flight software	6
Operations and maintenance	10
Ground support equipment	17
Total	1271

2.2.2 Operations [2]

Spacecraft operations are based around a cycle of 8 hours of signal acquisition (for each spot beam) and then a period of daily orbit maintenance. Spot beams at low and high latitudes require different portions of the circular relative orbit to form their synthetic aperture (i.e. equatorial locations need a North-South arc while high latitudes need an East-West arc) so the imaging periods for the different beams overlap only partially.

Several images modes are possible, such as (1) a basic mode where satellites work independently and (2) collaborative imaging where satellites work jointly to shorten the time required to form an image. Collaborative imaging requires accurate knowledge of the relative positions of the satellites and therefore is more demanding.

Other operational phases requiring particular consideration are (a) establishing the initial con-

stellation, (b) re-configuring the constellation to minimise the impact of failures, and (c) the end-of-life manoeuvres to remove spacecraft from the geostationary zone.

2.3 Mechanical

The radar antenna is a key component of the GeoSAR design and so the mechanical sub-group worked particularly on this area. The initial task was to select suitable antenna technologies (low mass per unit area, deployable, suitable for use at L-band, and space-demonstrated if possible). Following this, detailed designs for the antenna, spacecraft configuration and the spacecraft structure itself were developed.

2.3.1 Antenna [3]

[12] includes a survey of deployable antenna technologies for space applications which forms the basis of the antenna selection and design for GeoSAR. Table 2.7 summarises the options considered by the students and is based largely on the work of Tibert [12].

Table 2.7: Antenna technologies considered for GeoSAR [4]. (The abbreviations for the antenna types refer to those used by Wanat [4].)

Antenna	Class	Status	Diameter m	Mass kg	Frequency	Surface density kg m ⁻²
RRA	Umbrella	Orbit	5	24	15 GHz	1.22
WRA		Orbit	9.1	60	8.25 GHz	0.92
HRA		Orbit	12	127	?	1.12
HCA		Demo	15	291	11.6 GHz	1.65
EGS		Orbit	5.6	35	?	1.24
TT Halca	Truss	Orbit	8	230	22 GHz	4.58
TT ETS-VIII		Demo	13	170	4 GHz	0.81
AstroMesh		Orbit	12.25	55	2 GHz	0.36
SpringBack	Folded	Orbit	5.25	20	2 GHz	0.71
Sunflower1	Solid	Demo	4.9	31	60 GHz	1.64
Sunflower2		Study	15	?	?	?
Daisy		Demo	8	300	3000 GHz	6.0
MEA		Demo	4.7	94	30 GHz	5.42
SSDA		Demo	1.5	?	?	?
IAE	Inflatable	Orbit	14	60	22-86 GHz	0.39
LEO SAR		Demo	80 m ²	80	2 GHz	1.0

The main concepts studied for GeoSAR were the inflatable and Astromesh antennas. Of these, the lower cost favoured inflatable antennas and this has been selected. Detailed design of inflatable structures has been studied [3], and issues such as the inflation pressures needed to rigidise the structure satisfactorily or to maintain their shape, and the effects of damage due to micrometeoroids have been quantified. The inflation pressures assumed are sufficient to maintain the structural configuration.

[13] suggests that the damage due to micrometeoroids over the duration of the mission will result in over 100 kg of gas leakage rather than the small amount assumed by [3]. This indicates that further work is required on the antenna technology.

2.3.2 Configuration [4]

The main feature of GeoSAR which affected developing a suitable configuration was the decision to use two antennas. This provided some helpful symmetry (balancing solar radiation pressure torques about the mid-point). In addition to this, there were the usual constraints of maintaining lines of sight between attitude sensors, solar arrays, communication and payload antennas and

their desired targets as well as keeping thruster directions clear. Fuel and the inflation gas are stored centrally so that changes in mass properties as they are used is minimised.

2.3.3 Spacecraft [5]

Although structural design of a spacecraft is not trivial, the design of a structure for GeoSAR should not raise any fundamental issues affecting mission feasibility. A relatively conservative design has been developed, thus minimising mission risk. The thermal design has not yet been completed although the current assumption is that a passive design can be achieved.

Table 2.8 summarises the GeoSAR spacecraft mass properties.

Table 2.8: GeoSAR mass properties [9, p 7]

Axis	Stowed		Deployed	
	CG m	Inertia kg m ²	CG m	Inertia kg m ²
X	0	68.975	0	683.57
Y	0.475	88.649	0.707	1001.67
Z	0.750	102.169	0.750	702.27

2.4 Electrical power, Communications, Data Handling

A relatively standard electrical power system can be used, although compared to other low-cost missions which tend to be for LEO, the GEO environment and design lifetime (15 years) are both more demanding.

2.4.1 Power [6]

Table 2.9 summarises the satellite’s power consumption during the main imaging mode. For a first estimate, the solar arrays need to be sized to generate this average amount of power, and then batteries are sized to smooth out the power demand through the daily cycle. The next step is to consider performance during eclipse periods. If eclipses are rare, then it may be adequate to maintain the satellite in a safe but dormant state during the eclipse and accept the occasional loss of service. The current design is conservative in that it is able to maintain full performance even during eclipse and severe shadowing of the solar arrays.

The data of Table 2.9 suggest that the reaction wheel power consumption needs careful thought since it seems to account up to two-thirds of the total. If the wheels cycle sinusoidally daily between 0 and 180 W then the average power demand is 90 W and a battery can be used to help with peak power demand. The average power demand may also be reduced if some regenerative wheel braking can be used.

Table 2.10 gives the power budget for the eclipse period. Since the spacecraft is in shadow there will be no solar radiation pressure disturbance, therefore the attitude control system does not need to compensate actively but only maintain pointing. It should be possible to de-saturate the reaction wheels before eclipse periods to minimise power demand during eclipse. Assuming this is done, the power consumption during eclipse is 120 W, which for 2.5 hr corresponds to 300 W hr of energy storage. At 50% depth-of-discharge, this requires batteries capable of storing 600 W hr of energy. Li-ion batteries achieve 150 W hr kg⁻¹, so continued imaging during eclipse requires approximately 4 kg of batteries.

2.4.2 Communications [6]

A total power of 50 W (DC power) is required for the payload data link (using a 30 GHz carrier, 300 MHz bandwidth for 30 spot beams, 1 m² transmitting antenna and 10 m² receiving antenna). In addition to this, a small amount of power is required for the telemetry / telecommand links.

Table 2.9: GeoSAR electrical power requirements analysed by sub-system for the main imaging mode (no eclipse).

Sub-system	Power W	Duration	Comments
Data handling	20	continuous	Estimate
Communications	50	2 x 8 hr day ⁻¹	~1.5 W _{DC} per spot beam; each spot needs 8 hr to form image (may not run all spots simultaneously)
Communications	5	continuous	Est.; telemetry and telecommand
Power	10	continuous	Est. charge regulation etc.
Thermal	0		Assume purely passive thermal control
Attitude control	5	continuous	Sensors only (est.)
Attitude control	0-180	continuous	Reaction wheels (max. is when saturated) [9, p 41]
Orbit control	28.5	continuous	N-S station-keeping using FEEP thrusters (60 W per 1 mN thruster [9, p 45]) and 41 Ns impulse needed per day (Section 2.7). Equivalent continuous power demand is $\frac{60 \times 41}{0.001 \times 86400} = 28.5$ W (assuming perfect thruster alignment)
Total	100-280	continuous	Equivalent continuous power consumption

It will be useful to have an alternative ground station available for each group of satellites in case of bad weather or other interruptions - especially since a relatively high-frequency carrier is assumed.

2.4.3 Data Handling

Data handling has been assumed to be straightforward on-board the spacecraft. The system architecture shifts the data processing burden to the ground, where it will be easier and cheaper to provide high-power processing. It is also expected that continuing improvements in computing power and data storage will mean that by the time a GeoSAR mission could be launched the necessary data processing hardware will be even more practical.

We note that if it were possible to perform some of the processing on board the spacecraft then the bandwidth required for the payload datalink could be reduced significantly.

2.5 Payload

Within the payload work package [14], a review was made of possible applications for a GeoSAR mission. This provides a valuable guide to various application sectors (e.g. disaster monitoring, agriculture) and the response timescales and data products appropriate for them.

An analysis of the radar imaging equations [14] provides a useful summary of the dependence of image signal-to-noise ratio on system parameters such as antenna diameter (D), spatial resolution at the ground (L) and image integration time (T).

$$s/n \propto L^2 D^2 T \quad (2.1)$$

Thus doubling the aperture area means that the integration time could be halved without affecting the signal to noise ratio. Using a second spacecraft's antenna simultaneously is equivalent to doubling the receiving area and thus images in less than 8 hours are possible by using several spacecraft collaboratively.

Table 2.10: GeoSAR electrical power requirements analysed by sub-system in eclipse (assumes imaging and communicating simultaneously, but no orbit control while imaging).

Sub-system	Power W	Duration	Comments
Data handling	20	continuous	Estimate
Communications	50	2 x 8 hr day ⁻¹	~1.5 W _{DC} per spot beam; each spot needs 8 hr to form image (may not run all spots simultaneously)
Communications	5	continuous	Est.; telemetry and telecommand
Power	10	continuous	Est.; charge regulation etc.
Thermal	30		Est.; heaters required in eclipse
Attitude control	5	continuous	Sensors only (est.)
Attitude control	0-180	continuous	Reaction wheels (max. is when saturated) [9, p 41]
Orbit control	0		No station-keeping while imaging
Total	120-300	continuous	Equivalent continuous power consumption

2.6 Launch and Orbits

Although many spacecraft have been launched to geosynchronous orbits, it required some detailed study to identify suitable launch vehicles and estimate their cost. Only European launchers were considered since there was an assumption that ESA funding will be required if GeoSAR were ever to become an real mission.

Several options were considered for the propulsion system to achieve the geosynchronous orbit [15]:

- Initial launch to LEO then use a chemical booster
- Initial launch to LEO and then use a combination of chemical and electric propulsion
- Initial launch to GTO then use a chemical booster
- Launch directly into GEO

Although the option with a combined chemical / electric propulsion system to lift the orbit from LEO was likely to be lighter, the final selection was for a relatively conventional launch directly to (just below) GEO. The reasons for this were the relative simplicity and lower development risk of the GEO solution.

Table 2.11: Hydrazine thruster ΔV requirements per spacecraft (this ΔV corresponds to 9.5 kg of Hydrazine and assumes the 47 km radius relative orbit).

Function	ΔV m s ⁻¹	Comments
Orbit correction	8.0	Assumed Fregat insertion accuracy
Circularisation	48.5	
Inclination change	3.0	Move from GEO to geosynchronous
Apogee raising	0.4	„
Perigee lowering	0.4	„
EOL burn	8.0	Boost to 300 km above GEO
Total	68.3	

The geosynchronous orbits are designed to achieve a suitable motion of the satellite relative to the (rotating) Earth to allow aperture synthesis [16]. By adjusting the eccentricity and inclination, it is possible to obtain circular, elliptical or “figure-of-eight” orbits with the required amplitudes.

GeoSAR uses a circular relative orbit with relatively small diameter of 100-200 km. Because the perturbations from geostationary are small, the ΔV needed to reconfigure the relative orbit is not large.

Table 2.12: GeoSAR orbit parameters for the chosen circular relative orbits [16]. (All orbits are geosynchronous, i.e. $a = 42\,164.2$ km.)

Orbit	Eccentricity	Inclination °
47.57 km radius	0.0005774	0.06616
20.00 km radius	0.00023717	0.027177

2.7 Propulsion and AOCS

There are three main topics for Propulsion and AOCS:

- orbit acquisition,
- orbit control,
- attitude control.

A conventional hydrazine thruster is proposed for orbit acquisition (moving from the near-GEO orbit to which the launcher delivers GeoSAR spacecraft to the final operational orbit [16]).

Table 2.13 summarises the orbit control requirements. The solar radiation pressure compensation assumes that the spacecraft is not perfectly symmetrical, so that a force of $\sim 10\%$ of the radiation pressure force is required to maintain the orbit, i.e. a net force of $25\ \mu\text{N}$. This is comparable to the E-W station-keeping force and so the same ΔV is assumed. The dominant ΔV demand is that for North-South station-keeping. The sum of the other demands amounts to no more than 50% of this which seems reasonable. The total demand over the 15 year lifetime is significant (at about $1\ \text{km s}^{-1}$), and justifies careful design of the propulsion sub-system even for a feasibility study.

Table 2.13: GeoSAR Orbit control requirements for a 15 year mission [15, 17, 9, 16]. (Notes: (1) The LV error compensation allowance seems very generous relative to the EOL de-orbit burn. (2) An additional amount of ΔV will be required occasionally to de-saturate the reaction wheels.)

Function	ΔV m s ⁻¹	F_{min} μN	Comments
Initial orbit injection	65		[15, p 85–86]
Initial orbit LV error	70(?)		[15, p 85–86]
E-W station-keeping	30	20	$2\ \text{m s}^{-1}\text{yr}^{-1} \times 15\ \text{yr}$, [17]
N-S station-keeping	750	500	$50\ \text{m s}^{-1}\text{yr}^{-1} \times 15\ \text{yr}$, [17]
SRP compensation	30	≤ 250	Compensates non-cyclic torques
Re-configure orbits	150		$\sim 5\ \text{m s}^{-1}$ per change [16, p 27] Assume 2 changes per s/c per year
EOL de-orbit	8		[16, p 28]
Total	1041		Assumes LV correction = $8\ \text{m s}^{-1}$

Assuming that the station-keeping corrections are provided by a constant low-level thrust on a spacecraft of mass 300 kg, the minimum size of the thrust can be estimated:

$$\begin{aligned}
 m\Delta V &= FT \\
 F_{min} &= \frac{m\Delta V}{T}
 \end{aligned}
 \tag{2.2}$$

For N-S station-keeping, the annual requirement is 50 m s^{-1} per year, or 0.137 m s^{-1} per day. For a spacecraft of 300 kg this corresponds to an impulse (force x time) of $300 \times 0.137 = 41 \text{ Ns}$ per day.

The orbit control system is based on field effect electric propulsion (FEEP) [9]. This has the advantage relative to a chemical propulsion system of a low system mass for a 15 year lifetime.

The large antennas mean that attitude control requires relatively large reaction wheels for a spacecraft of GeoSAR's mass. This at least partially justifies the relatively high power budget allocation for the reaction wheels. With a suitable configuration it should be possible to ensure that the attitude disturbances are largely cyclical and so momentum dumping will not be a high demand on GeoSAR.

Chapter 3

Conclusions

The design developed demonstrates the feasibility of the GeoSAR concept at a cost which is expected to be significantly lower than a solution based on conventional LEO SAR technology. The performances of GeoSAR and “LeoSAR” are not directly comparable (e.g. GeoSAR can achieve interferometry on timescales of just a few hours, LeoSAR will have better spatial resolution and covers polar regions), but they are close enough for a comparison of the two concepts to be worthwhile.

The baseline developed appears to be conservative (e.g. the payload mass fraction is only 7%) and so a significant mass reduction seems possible. This opens up the possibility of launching 4 satellites at a time and is also likely to reduce the cost per spacecraft. Bearing these factors in mind, a simplified mission to focus on one latitude position with only 2–3 spacecraft seems realistic for a mission cost of (very) approximately € 200 M. This estimate assumes “conventional” design and manufacturing, and if the low-cost practices of companies such as Surrey Satellite Technology Limited (UK) were to be adopted this cost could be reduced still further.

3.1 Future Work

Several areas of further work are suggested by this study. These include:

1. Lightweight antenna design: this is a key technology and its reliability and feasibility are critical to GeoSAR. Current assessments of micrometeoroid damage suggest that an unprotected inflated structure would lose a significant mass of gas due to leakage over the 15 yr mission. More work is required to evaluate antenna technology options, and there is a risk that other technologies will be either more expensive or massive than the current inflatable design. The geometric accuracy of deployment and its stability throughout the mission are also important.
2. Signal processing: there are aspects of the detailed image formation as well as the basic measurement physics which need more study (e.g. the effect of a dynamic atmosphere during the integration period on imaging).
3. Configuration / attitude and orbit control: the large antennas imply potentially large disturbance torques. Reaction wheels sized to handle the cyclical torques with the current configuration dominate the power budget: alternative configurations may reduce this impact.
4. Orbit determination: for collaborative imaging it may be necessary to achieve precise measurement (and possibly control) of the relative orbits of spacecraft in a formation.
5. Operational modes and constellation size: The current mission is sized to maintain full performance through such rare occurrences as a 2.5 hr lunar eclipse. The impact of such decisions should be assessed to ensure that they are justified in terms of the benefit to the mission, and whether some flexibility in imaging modes may avoid unnecessary costs.

6. Topics not yet analysed in detail, such as the thermal design and simultaneous imaging of high and low latitude regions, should be assessed to check their impact on the mission.

In several areas the GeoSAR design is conservative and it is plausible that on further iterations of the design the cost and mass can be reduced. This would add to its attraction as a concept, and suggests that among options for future Earth observation missions, GeoSAR deserves serious consideration.

Bibliography

- [1] Emily Brownbill. GeoSAR: System engineering: budgets. Group project report, MSc in Astronautics and Space Engineering, School of Engineering, Cranfield University, March 2006.
- [2] Warren Hamilton. GeoSAR: System design, Operations. Group project report, MSc in Astronautics and Space Engineering, School of Engineering, Cranfield University, March 2006.
- [3] Mathieu Lesieur. GeoSAR: Mechanical sub-system (antenna). Group project report, MSc in Astronautics and Space Engineering, School of Engineering, Cranfield University, March 2006.
- [4] Fred Wanat. GeoSAR: Mechanical sub-system (configuration). Group project report, MSc in Astronautics and Space Engineering, School of Engineering, Cranfield University, March 2006.
- [5] Steven Allen. GeoSAR: Mechanical sub-system (spacecraft). Group project report, MSc in Astronautics and Space Engineering, School of Engineering, Cranfield University, March 2006.
- [6] James Marshall. GeoSAR: Electrical power, communications and data handling. Group project report, MSc in Astronautics and Space Engineering, School of Engineering, Cranfield University, March 2006.
- [7] C. Prati, F. Rocca, D. Giancola, and A. Monti Guarnieri. Passive geosynchronous SAR system reusing backscattered digital audio broadcasting signals. *IEEE Transactions on Geoscience and Remote Sensing*, 36(6):1973–1976, November 1998.
- [8] J.R. Wertz and W.J. Larson. *Space Mission Analysis and Design*. Space Technology Library. Microcosm Inc. and Kluwer Academic Publishers, third edition, 1999.
- [9] Martin Gavin. GeoSAR: AOCS. Group project report, MSc in Astronautics and Space Engineering, School of Engineering, Cranfield University, March 2006.
- [10] David Hall. BIS presentation 20/7/05, 2005.
- [11] Canadian Space Agency. Report on Plans and Priorities, www.space.gc.ca/asc/eng/resources/publications/rpp-2004-annexes.asp, 2005. Section 7-3-2.
- [12] Gunnar Tibert. *Deployable tensegrity structures for space applications*. PhD thesis, KTH Stockholm, April 2002.
- [13] S.E. Hobbs and D. Bruno. Quantifying micrometeoroid impacts on large space structures to assess attitude disturbance and surface damage: GeoSAR case study. In *Proceedings of the 7th conference on Dynamics and Control of Systems and Structures in Space, Greenwich UK*, pages 65–76. Cranfield University Press, 2006.
- [14] Alex Lucas. GeoSAR: Payload. Group project report, MSc in Astronautics and Space Engineering, School of Engineering, Cranfield University, March 2006.
- [15] Jan Butynski. GeoSAR: Launch and Orbit Acquisition. Group project report, MSc in Astronautics and Space Engineering, School of Engineering, Cranfield University, March 2006.

- [16] Steven Jefferys. GeoSAR: Mission analysis. Group project report, MSc in Astronautics and Space Engineering, School of Engineering, Cranfield University, March 2006.
- [17] Fortescue Stark and Swinerd. *Spacecraft systems engineering*. Wiley, third edition, 2003.

Appendix A

Organisation of the Project

The division of responsibilities of the project between the students taking part in the project is described in the following table.

Description	Student(s)
System engineering	Emily Brownbill Warren Hamilton
Payload	Alex Lucas
Operations	Warren Hamilton
Structure & Thermal	Steven Allen Mathieu Lesieur Frederic Wanat
Electrical	James Marshall
Orbits / AOCS	Jan Butynski Martin Gavin Steven Jefferys

Table A.1: GeoSAR work package breakdown and allocation.

Appendix B

Individual Report Executive Summaries

Executive summaries for all the project reports are given in this appendix. Full copies of the reports may be referred to at the School of Engineering, Cranfield University, UK.

The summaries have been only lightly edited. The reports have been examined and gross errors that were identified have been corrected. However, it is not possible to guarantee that no errors remain; users of the summaries and reports should bear this in mind.

The reports are ordered alphabetically by author surname. Table B.1 lists the students and shows their individual responsibilities within the project.

Student	Work area
Allen	Mechanical design
Brownbill	System engineering, budgets
Butynski	Orbital analysis
Gavin	AOCS
Hamilton	System engineering, operations
Jefferys	Orbital analysis
Lesieur	Mechanical design
Lucas	Payload
Marshall	Electrical
Wanat	Mechanical design

Table B.1: Sub-system responsibilities for each student

B.1 Steven Allen: GeoSAR, Mechanical Subsystem

People are taking more of an interest in the condition of the planet which we inhabit. Concerns regarding global warming and other environmental issues justify earth monitoring from satellites. In recent times this planet has witnessed several disasters caused on a huge scale. Emergency services and other agencies struggle with their allocation of resources. If a versatile satellite constellation could provide regular, reliable and frequent images of such places it would empower those decision-making bodies. Resources could be allocated to the regions most affected and areas of potential risk could be identified. This is one of the many benefits the GeoSAR group project focused upon.

GeoSAR is a mission concept of a highly versatile collection of satellites that could provide various interested parties with an array of data about the earth. The main driver was maintaining a low cost mission and the GeoSAR concept employed several mass saving technologies. Synthetic aperture radar allows a much smaller antenna to effectively produce images of the resolution of a much greater antenna aperture. Radar can provide images whose quality does not depend on lighting or weather conditions. Vast areas of the populated earth's surface are currently illuminated with electromagnetic radiation from existing broadcast satellites. Why not utilise this energy? This was the constraint with which the group had to work. A requirement was to design a passive system that would reduce the mass and therefore cost, as GeoSAR does not require a transmitter onboard.

The aim was to provide the GeoSAR constellation with the capabilities to achieve as many various applications as possible that would widen the consumer market. With a vast range of varying interested bodies from government departments, relief agencies and even farmers interested in soil moisture and temperature variations, the mission could prove a commercial success. Any market research into the potential market for consumers is outside the scope of this project. The project investigates the feasibility of having a constellation of satellites that are adaptable and provide frequently updated images.

This report is one of a collection of ten, and focuses on the research into antenna concepts with the aim to select a low mass antenna that meet the requirements of the mission. The design of the structure is also discussed and the iterative process of designing is highlighted.

B.2 Emily Brownbill: GeoSAR, Systems Engineering

The GeoSAR (geosynchronous synthetic aperture radar) mission consists of 12 low cost passive satellites in geosynchronous orbit which will use synthetic aperture radar to monitor the Earth's surface for applications such as surface deformation, disaster monitoring, climate change and soil moisture. The mission is intended to last 15 years and it is assumed that the mission customer is the European Space Agency (ESA). The following sections summarise the work carried out for the systems engineering work package and include a brief description of the mission.

B.2.1 Introduction

The remote sensing SAR instrument is becoming more frequently used on board spacecraft as it has the unique ability to synthesise a very long antenna and obtain images with very high resolution, approaching 10 m. Recent missions which have used SAR include ERS-1/2 and Envisat, and they have demonstrated the usefulness of this instrument through the unique data they have obtained about Earth's land, atmosphere, oceans and ice. Most SAR missions are positioned in a Sun synchronous, low Earth orbit and use active SAR. To date, there have been no passive, geosynchronous SAR missions, but there has been much research into the feasibility of developing such a design. The concept of developing such a mission is very interesting due to the fact it can be very low cost as there is no need to have any complex components onboard the spacecraft other than large receiving antennas. Also, another advantage in this design occurs due to the use of geosynchronous orbits, as one geosynchronous spacecraft can monitor one third of the Earth's surface. This compares favourably to current low earth orbit (LEO) SAR spacecraft that would require approximately 15 spacecraft to provide daily global coverage for 15 years.

Constraints

The following constraints were placed upon the GeoSAR mission and it was a requirement that these were operated within during all phases:

- Cost of monitoring a continental region to be less than €1 bn.
- The GeoSAR satellites are to be passive.
- The mission lifetime will be 15 years.
- The mission will involve a bi-static system.
- Geosynchronous satellites will produce an image in less than 24 hours.
- Spatial resolution is to be 100 m.

B.2.2 Systems Engineering

The systems engineer must provide insight into how important it is to coordinate designs from the top down, to create a harmonious atmosphere with all subsystems so they communicate well with each other and at the same time maintain focus on mission goals, needs and requirements. GeoSAR primary mission drivers were:

- Cost
- Performance
- Communication

Trade-offs performed by each work package weighted these particular drivers highly, ensuring that project development stayed in line with mission goals. To determine the mission concept that the GeoSAR project would be most suited for, numerous concepts were created. These concepts were then traded off, resulting with two highly scoring concepts;

- Dual Formation Flying
- Disaster Monitoring Constellation

Due to these concepts being both highly scored and compatible with one another it was decided to combine the two initial concepts to produce an initial baseline concept as follows. The system would utilise between two and eight satellites in a constellation. The spacecraft would use an Astromesh antenna on a single L-band frequency, and applications would include the monitoring of flooding, seismic activity, tectonic movement, subsidence and topographic mapping.

Conclusion

The final concept design was established during phase C of the project when the optimum concept was altered in terms of the total number of spacecraft, which was increased to 12, and the antenna technology (inflatable instead of Astromesh). This was due to redundancy, side-lobe cancelling and global coverage issues. The 12 satellites would be split into three groups of four situated above America, Asia and Europe. Each group of four satellites would be arranged to provide two concentric ground tracks, with two satellites in each of the ground tracks.

B.2.3 System Design and Budgets

The systems engineer was responsible for the mass and cost budgets. Mass and cost values were submitted to the systems engineer and final budgets were produced as illustrated in Tables B.2, B.3 and B.4.

Table B.2: GEO, LEO Cost Comparison

Parameter	FY06 €M
FTU	65
RDT&E	284
1 satellite	349
12 satellites	1066
4 Launchers	172
Flight Software	6
Operations and Maintenance	10
Ground support Equipment	17
Total cost	1271

Table B.3: System Mass Budget

Component	Mass (kg)
Spacecraft dry mass	191
Spacecraft dry mass with primary structure	284
Loaded mass	321
Total mass of spacecraft in final orbit	303

Table B.4: Subsystem Dry Mass

Subsystem	Dry mass (kg)
Payload	27.25
Electrical	71.22
Mechanical	66
Mission Analysis/ AOCS	72
Margin	55

It can be noted from the tables above that the spacecraft dry mass is 191 kg, the loaded mass is 321 kg and the total mass of spacecraft in final orbit is 303 kg. Two methods were used to calculate the cost of the mission. The first involved using Larson & Wertz's cost estimating relations (CER). These CER estimate the cost in thousands of dollars adjusted to the fiscal year 2000. The tables were formed by compiling information from previous missions. This also means that they are limited to certain parameter ranges. The second method was performed by comparing the cost of geosynchronous satellites to the cost of the LEO constellation satellites. From Table B.5 it can be seen that the cost of geosynchronous satellites is considerably less than the cost of LEO satellites when considering global coverage.

Table B.5: GEO, LEO Cost Comparison

Satellite	Cost (€M)
15 LEO S/C baseline	4500
1 GEO baseline	1125
3 GEO baseline	3375
3 GEO cost model	479

B.2.4 Conclusions and Further work

The mission analysis and electrical subsystems were the main contributors to the mass and in the future it would be advisable to reduce the mass of these areas, particularly the power control unit for the electrical subsystem, which alone masses 23 kg. It has been decided it is desirable to reduce the spacecraft dry mass to secure 4 spacecraft in one launcher if possible. Methods of improvement could include adopting ESA standards for mass budget margins. The cost of the GeoSAR mission has been calculated to be €1.271 bn. This mission is low cost in theory when keeping in mind that, for global coverage, the cost of three GEO satellites is less than the cost of the greater number of LEO satellites needed to provide the same coverage. Overall the GeoSAR project has successfully fulfilled its objectives and would be able to operate within the stated constraints. By these criteria the project can be judged as a success.

B.2.5 Reference

Larson, W. and Wertz, J. (1999). *Space Mission Analysis and Design*, 3rd edition. Kluwer Academic Publishers, Dordrecht.

B.3 Jan Butynski, Mission Analysis: Launch and Orbit Raising

The GeoSAR project aim is to design a low-cost constellation of satellites to be placed in a geosynchronous orbit using passive synthetic aperture radar technology to image the surface of the Earth. The key technology onboard the satellite is the payload antenna. The antenna should be a lightweight design to minimise satellite mass. This will lead to a mission cost reduction as less propellant will be required and a cheaper launch will be possible. The final choice of constellation contains twelve satellites in near geostationary orbits. This includes three independent stations each containing four satellites. Station one has a view of North and South America, station two has a view of Africa and Europe, and station three has a view of Asia. Station one will be centred on a longitude of 90° W, station two at 25° E and station three at 105° E.

The satellites are to be of the mini classification, an initial mass estimate per satellite was 300 kg - 400 kg. The final mass at the critical design review was 322 kg. A shared launch was decided upon to dramatically reduce cost. The launch vehicle of choice must be able to boost twelve satellites to the near geostationary orbits at a minimum cost but with good reliability. The search for launch vehicles has been limited to European launch services as the mission has been assumed as ESA funded.

The satellites must have sufficient propulsion onboard to correct any injection inaccuracies after the launch and of course to attain the final orbit. The launch vehicle will not be able to place each satellite into the exact final orbit. Each satellite will be given the responsibility of attaining its exact final orbit following its deployment from the launch vehicle.

B.3.1 Launch Vehicle Selection

The mission requirements for the launch system have been identified above. Twelve mini satellites with a mass of 322 kg must be launched to near geostationary orbits with the main aim being to keep cost as low as possible. The requirements dictate which launch vehicles will be considered as possibilities for the launch of the GeoSAR constellation. A short list of six European commercial launch systems has been drawn up for an in-depth trade-off study to be conducted (Table B.6).

The main parameters to be considered are the launch cost and reliability. However there are also many other factors involved. These include availability, complexity, performance margin, injection accuracy, replenishment capacity, maximum loads, frequency requirements, uncertainty and cleanliness level in the payload fairing.

Table B.6: The trade-off between the six most appropriate LV's. Soyuz-Fregat is clearly the best choice of launch vehicle

	Weight	Ariane 5ES	Ariane 5ECA	Ariane 5ECB	Proton M	Soyuz- Fregat	Zenit 3SL
Launch cost (\$M)	272	238	250	224	172	300	
Cost	10	3	4	4	8	10	5
Reliability	8	4	6	4	9	9	7
Availability	6	3	3	3	7	8	6
Complexity	6	4	3	6	9	9	9
Performance Margin	5	2	3	7	6	8	7
Injection Accuracy	4	8	8	8	6	5	6
Replenishment cap.	4	6	4	2	3	8	8
Maximum Loads	4	7	7	7	6	6	4
Frequency req.	4	5	5	5	7	6	8
Uncertainty	3	4	7	4	10	4	10
Cleanliness Level	2	8	8	8	8	8	3
Total (out of 560)		246	272	277	412	442	371
Percentage Total		44%	49%	49%	74%	79%	66%

Soyuz-Fregat is clearly the best choice of launch vehicle. Table B.6 shows the trade-off that

was performed. Cost is the most important parameter, therefore it is given a weighting of ten. Reliability is the next most important parameter with a weighting of eight.

The Ariane 5 family of launchers would provide the GeoSAR satellites with a GTO. Therefore the satellites would have to circularise the orbit with a ΔV of approximately 1502 m s^{-1} with a mission specific upper stage. However, the mission could be simplified by using a launch vehicle with an upper stage that boosts the satellites directly to GEO. This would be the case if a Proton M/ Breeze M, Soyuz-Fregat or Zenit 3SL launch were chosen. This is the reason why the Ariane 5 family has scored poorly in terms of mission complexity and the remaining three launch vehicles have each scored nine.

The Soyuz-Fregat consistently scores highly and is the lowest cost and highest reliability solution. The lowest scores for the Soyuz come from the injection accuracy and the uncertainty. With everything considered, the Soyuz-Fregat from Europe's Spaceport is the chosen launch vehicle. The Proton M / Breeze M comes out of the trade-off with a good score. It is defeated, however, by the Soyuz in terms of cost, availability, performance margin and replenishment capacity. The Zenit 3SL also scores well. The Ariane 5 family provides the least favourable launch vehicles out of the six considered.

Although the Proton M vehicle out-scores the Zenit 3SL, the Zenit is chosen as the backup option. It is important to design the satellites to be compatible with more than one launch vehicle in case of any launch failures. It also gives more leverage when negotiating launch prices. The Zenit 3SL has been selected as it has a very similar lift capacity to the Soyuz-Fregat. Each vehicle can launch three satellites. Therefore it is relatively simple to design the GeoSAR satellites to be compatible with both. The Proton M would lift six satellites per launch making it very complicated to design the satellites to be compatible with both the Soyuz and Proton.

B.3.2 The Launch

The launch of the GeoSAR constellation of twelve satellites is to be performed by four Soyuz LVs from Europe's Spaceport (due to commence launches from 2008) each placing three satellites into orbit. The Fregat upper stage will be used to take the satellites from LEO to GEO. After the Fregat deploys the satellites, they will separate and each perform manoeuvres to attain the correct final orbit. The cost of four launches is \$172million

B.3.3 Attaining the Final Orbit

Each launch vehicle will carry three satellites, one destined for each station. One satellite will be headed for a final longitude of 90° W , one for 25° E and one for 105° E . This method (method 1) consists of the same launch strategy performed four times. The alternative solution is method 2, which consists of launching one satellite to each station (in the first launch) followed by a launch of three more satellites to America, then three to Africa, and finally three to Asia. Option 1 is the simpler solution and gives a better performance if launches three or four were delayed or cancelled for any reason.

The Fregat must place the three satellites in a drift orbit so that each one can be sent to the correct station. This is done by applying a slightly smaller ΔV (at GTO apogee) than that which would be required to circularise the orbit. The required ΔV is 1454 m s^{-1} . The semi-major axis of the drift orbit is smaller than the GEO semi-major axis. This means that the time period of the drift orbit is less than one sidereal day. Each satellite drifts easterly (relative to the ground) at a rate specified by the drift orbit perigee. When each satellite reaches the correct longitude its 1 N thruster is fired to halt the drift. The 1 N thruster has been sized so that the solar arrays are not damaged by the thruster's impulse. This is the same thruster that will be used to place each satellite in its exact final orbit.

A trade-off was performed to decide what the orbital parameters of this drift orbit should be. For example, to place the satellites on station quickly after launch, a drift orbit with a high drift rate is required. This means a lower perigee. It also means that the Fregat is not required to do as much work as it places the satellites in a lower energy orbit. The satellites must, however, apply a larger ΔV to circularise their individual orbits when they reach the correct longitude. This will halt their eastward drift. This means that each satellite is required to have a larger propulsion

system onboard, thus increasing their individual mass. However the propellant required from the Fregat upper stage will be less. As the ΔV required of each satellite increases, the overall mass for the LV to lift is increased. On the other hand if the drift orbit is to have a very slow drift east (to save mass) the satellites may take months to arrive on station. With the final selected drift orbit, the satellite intended to image America will insert into its final orbit 6 days after launch. The satellites used to image to Africa and Asia take longer to reach their final orbits. They arrive 13 and 18 days respectively after launch. This solution is a compromise of system mass versus duration to reach the final orbit.

The Fregat upper stage will apply its apogee burn when directly above a longitude of 147° W on the surface of the Earth. From here, the satellites must separate from the upper stage and after they each drift to their correct longitudinal positions they will enter their final orbits. They must drift for at least three days before they fire their hydrazine thruster. This is in order that the attitude and orbit of the satellite can be determined and corrected if necessary. The inflatable solar arrays must also be deployed and rigidised.

B.3.4 ΔV Budget

The ΔV required from the hydrazine thruster consists of phases for orbit correction, orbit raising and satellite disposal. The total ΔV required is 135 m s^{-1} per satellite. This equates to a hydrazine mass of 21 kg. More hydrazine will also be present onboard the satellites for the antenna inflation mechanism. Each satellite will be identical with a final mass of 322 kg on launch. The capacity of the Fregat to inject the satellites into the required orbit has been calculated as 1459 kg. There is a healthy performance margin and the satellite mass may rise to 405 kg before the launch strategy must be revised. If the mass per satellite remains as 322 kg then there is space for an auxiliary payload of 150 kg. If such a payload could be found, the launch cost would be reduced further.

B.4 Martin Gavin: GeoSAR AOCS

B.4.1 Introduction

This is a report about the selection and sizing of the Attitude and Orbit Control System as part of a feasibility study for the GeoSAR project which is was carried out at Cranfield University. GeoSAR is geosynchronous passively powered synthetic aperture radar satellite. The aims of this project are to produce a concept design of the GeoSAR satellite, which could act as a low cost replacement to the existing LEO constellation. This report documents the process followed in performing this project:

1. Identify the requirements and operational parameters
2. Review the available technologies and systems
3. Evaluate these systems against the mission requirements and operational parameters.
4. Select the most appropriate solution
5. Configure this solution for implementation on GeoSAR

B.4.2 AOCS Requirements

Based on the GeoSAR technology and philosophy, the following set of requirements where determined as shown in Table B.7.

Table B.7: GeoSAR AOCS Requirements

Satellite Stability	Continuous point accuracy for periods of up to 8 - 12 hours
Pointing Accuracy	$\pm 0.2^\circ$
Initial orbit acquisition	ΔV of 135 m s^{-1} to be produced within 3 hours time period
Mission Duration	Sufficient redundancy in order to provide full functionality for a 15 years mission
Satellite mass	The AOCS must be as light as possible

B.4.3 External perturbations

In order to design an AOCS system, the external perturbation must be known. For the scope of this project the following perturbations where considered. The results are shown in Table B.8.

Table B.8: Magnitude and Nature of External Perturbations on GeoSAR

Name	Magnitude	Direction	Nature
Gravity Gradient	$3.56 \times 10^{-8} \text{ Nm}$	Rotational	Constant
Solar Pressure			
X-X axis	$4.14 \times 10^{-4} \text{ Nm}$	Rotational	Cyclic
Y-Y axis	$2.44 \times 10^{-4} \text{ Nm}$	Rotational	Cyclic
Z-Z axis	$6.88 \times 10^{-5} \text{ Nm}$	Rotational	Cyclic
Magnetic Field	$2.12 \times 10^{-5} \text{ Nm}$	Rotational	Constant
Aerodynamic	Neglected	Rotational	Constant
E - W	$20 \mu\text{N}$	Translational	Constant
N - S	$508 \mu\text{N}$	Translational	Cyclic

B.4.4 Rotational actuators

In order to select the optimum rotational actuator a study of the current available technology was conducted. The different methods that were considered were:

1. Gravity Gradient
2. Spin & Dual Spin Stabilization
3. Reaction/momentum wheels
4. Thrusters
5. Magnetic Torquers
6. Control Moment Gyroscopes
7. Solar Radiation

From the technologies considered, reaction wheels were chosen since this was the only method that could practically control the attitude of the satellite to the needed accuracy. The reaction wheels for each axis were sized in accordance to the equations outlined in page 370 of Wertz and Larson (1999). The attitude control system consists of 4 reaction wheels, 3 primary and 1 to provide redundancy. The 3 primary reaction wheels are aligned with the major axes. The redundancy reaction wheel is orientated so that it has a component of rotation in all 3 major axes. This is so that if 1 of the primary reaction wheels fails, using a combination of the remaining 3 reaction wheels, full attitude can still be achieved. This configuration of the reaction wheels is shown in Figure B.1. This layout of the reaction wheels gives complete redundancy. Since this is a very well developed technology, 15 years of operation should be achievable.

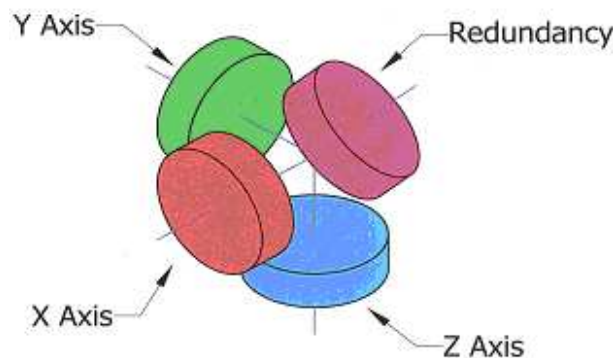

Figure B.1: Reaction Wheel Configuration

B.4.5 Translational Actuators

Translational actuators are needed in order to perform the station keeping and orbit acquisition manoeuvres. There is no constraint that the system that is selected must perform both activities. So an overview of the available technologies was performed and the following technologies were short listed. This shortlist is shown in Table B.9 for both station keeping and orbit acquisition activities.

The mono propellant system was determined to be the optimal solution to the orbit acquisition requirement. This was because it could be integrated into the existing hydrazine inflation system for the antennas. After performing a trade-off shown in Table B.10 it was found that a hydrazine system was not suited to fulfil the station keeping role as it would require much more mass than for other options. From the trade-off analysis it was found that FEEP's was the best technology to perform the station keeping activity.

Table B.9: Station keeping and Orbit acquisition actuator shortlist

Station Keeping	Orbit Acquisition
Mono-propellant	Mono-propellant
ArcJet	Bi-propellant
Resistojets	Resistojets
Ion Thruster	
FEEP's	

Table B.10: Station Keeping actuator trade-off

	Weighting	Mono-propellant	Ion Thruster	FEEP's
Fuel sloshing	3	-1	1	1
C of G moment	4	-1	1	1
Adaptability	4	1	-1	-1
Redundancy of the config.	5	1	-1	1
Thermal management	1	1	0	1
Control authority	2	1	0	-1
Affect on structure	3	1	1	1
Total		8	1	10

B.4.6 Conclusions

Although a large majority of the technology that has been proposed for the GeoSAR satellite is experimental, we have assumed that the proposed technologies used will have matured and been flight tested by the time that the GeoSAR mission is to be launched in 2012. We feel that the baseline design would be able to perform the GeoSAR mission as intended as it can be demonstrated to fulfil the requirements. Through use of reaction wheels, the required continuous pointing accuracy requirements have been met. And through adequate sizing, the reaction wheels will not have to dump momentum during the imaging period. The GeoSAR satellite uses a FEEP system to perform station keeping activities and a hydrazine system to perform the orbit acquisition activities. This has led to the lightest complete secondary propulsion solution. The thrusters have been configured in such a manner, that there is full redundancy in all 6 degrees of freedom. Also all the actuators that have been selected for use on the GeoSAR have all been sized so that they maintain adequate controllability over the satellite at all times.

B.4.7 References

Larson W. J., Wertz J.R, 2003, Space Mission Analysis And Design, 3rd edition, Kluwer Academic Publishers, Dordrecht / Boston / London.

B.5 Warren Hamilton: GeoSAR, Operations structure

B.5.1 System summary

GeoSAR is a concept for a passive synthetic aperture radar system, orbiting at the geostationary radius. It is designed to be a cheap and useful alternative to a series of low earth orbit radar satellites, and to provide a unique capability for imaging regions with a very short time delay between individual images. This will provide a capacity that is unfulfilled by the current generation of radar satellites, each of which has a revisit period of the order 35 days. The GeoSAR system is designed so that the minimum revisit period is 12 hours, an improvement of a factor of 70.

Operational structure

The structure of the GeoSAR system is quite unique, representing the requirements of the system. For the full system, there will be a constellation of 12 satellites, orbiting in three segments of four satellites each. These three segments will be positioned over the main land masses; there will be one stationed over the Americas, one over Europe and Africa, and one over Asia and Oceania. The concept involves the collection of scientific data using the technique of synthetic aperture radar, and this requires a motion of the satellite relative to the target in order to form this aperture. In order to generate this motion, the satellites are placed into an orbit that is not geostationary, but geosynchronous with a slight eccentricity and inclination. This is enough to produce orbits that follow a circular path relative to the geostationary position, with a diameter large enough that a section of it can be used to form the required synthetic aperture.

For the GeoSAR system, the four satellites that make up one segment are arranged into two concentric circles. The outer circle will be used to create the synthetic aperture, and the inner circle will use the properties of radar systems to provide a “lobe cancelling” effect, which will increase the quality of the resultant image. Because the constellation is at geostationary radius, they have a viewing area of approximately 1/3 earth’s surface at any time. Unfortunately, the extreme edges of this area are not useful for imaging, as they are too distorted and obscured by the atmosphere. For the selected arrangement of satellites this is not a major problem, as the vast majority of land surface is visible to the three constellation segments. Within the viewing area, almost the entire surface is covered by the spot beams from the satellites antenna dishes. This means that we have the capability to select specific spot beams that cover the sections of land that we are interested in, and image them. Theoretically, we have the ability to image the entire visible surface during one imaging cycle, but this is likely to be constrained due to limitations on the downlink bandwidth. The ability to select portions of the land surface which to image during any one cycle is a major advantage over the LEO spaceborne radars, which are required to wait until the groundtrack passes over the selected spot in order to image it.

Duty Cycle

The duty cycle for the system is based around a repeat period of 12 hours. This allows the cycle to be synchronised with the orbital period, and will greatly simplify the operations procedures. In keeping with this duty cycle, the two satellites that share each orbit are phased exactly 180° from each other. This will simplify the data collection as each satellite will start and end its duty cycle at exactly the same points. In order to achieve this, each 12 hour cycle consists of 8 hours of imaging, and the remaining time is allotted for housekeeping tasks, including orbital correction. This orbital correction burn will ensure that the start and end points are always the same for each cycle. The benefit of this is that it allows our system to perform temporal interferometry, which requires two images of the same spot to be taken from exactly the same point in space. Then the two images can be compared in order to analyse the differences between them.

Timeline

The timeline that is envisioned for the development and implementation of the GeoSAR system is quite extended. The design has been performed on the assumption that the launch date would not be for at least 10 years, in order to allow for development of the technologies involved and

engineering of the system. The system is designed to be operational for an optimum 15 years, so the end of the mission is not expected to be until at least 2030. This timescale should allow the full development of technologies that are still in their infancy. Examples of this are the inflatable structures, and data processing of the returned signal.

B.5.2 Ground system

The ground segment of the mission is to consist of three ground stations, and one central command and control centre. Because of the spacing of the satellite segments around the geostationary orbit, it is not possible to stay in constant communication with them by using only one ground station. The three ground stations that are to be employed are required to lie inside the fields of view of their respective satellite segments, hence it is expected that the ground stations will follow current placing of ESA ground stations, and there will be one located in Australia, one in Europe, and one at Kourou in French Guiana. Because of the details of the system, it is unfortunately not possible to share existing stations with other satellite missions, as the satellites need to be in constant communications with the ground station during the imaging process. There is no significant data storage on the satellites, and all of the received radar data are transmitted directly to the ground station with no analysis by the satellite. It is expected that the satellites will all communicate with the same ground station simultaneously, using frequency division to separate the signals.

Command centre

The central command and control centre will be located at ESOC in Darmstadt, Germany. This command centre will be the central hub through which the mission is organised and the satellites commanded. The individual ground stations will not undertake any analysis of the data that they receive, and will transfer the data directly to the command centre. The processing and analysis of the radar data collected will require a large amount of processing power, but given the timescales of the mission this is not expected to be a constraint. The data processing will consist of using the received data signals and comparing them to a reference signal collected on the ground in the selected imaging area. The main image will be processed using the information gathered from the satellite in the outer ring, and the information gathered from the inner ring will be used to increase the quality of the image by removing a large amount of the noise from the signal. The command centre will also fulfil the task of data distribution and archiving. The data will be distributed according to who requested the information, and how long it has been stored. The archived data will require a large amount of space to store, but again given the time constraints of the mission this is not expected to be a problem. The users of the system are expected to fall into three main groups:

- Government institutions,
- scientific research groups, and
- interested third parties.

These groups will then feed back into the system by submitting user requests for locations and times that they would like imaged. This information will be used as the input to the scheduling software, which will decide the satellites' duty cycles and imaging schedules.

B.5.3 Failure analysis

Failure analysis was also conducted on the satellite and its subsystems, and gave information about the critical systems onboard and what could be done to improve the mission risk. This failure analysis consisted of examining each of the satellite's subsystems in turn, and determining the results if the system or a component of the system failed. It was found that the components of the Radar dishes, pressurisation system and communications system are the most mission-critical systems. A failure in any one of these systems could cause the loss of all operational capability of the spacecraft.

The radar dishes are the heart of the science part of the mission. Because each of our satellites carries two radar dishes, there is some inherent redundancy, but a serious failure that affected both could leave the satellite without a science payload. The pressurisation system is important because it controls the deployment of the radar dishes and the solar panels, and so a failure in this system would mean a catastrophic failure for the mission. The communications system was deemed to be very important because of the structure of the data flow for our mission. The design calls for the communications system to be constantly active during imaging operations, constantly transmitting the received data to the ground. A failure in this system would mean that no science data could be returned from the satellite, and therefore mean that the satellite is useless. Hence, these systems will be singled out for more extensive testing than the rest of the system.

B.5.4 Autonomy

Autonomy was found to be an important part of our system design. In the interests of reducing the cost of the system, several alternatives were considered. Because of resource constraints on the satellite hardware, and the design of the system, it was found unsuitable to implement autonomy onboard the satellite, and as such it was decided to implement it at the command centre, in the area of scheduling and request processing. At the ground, autonomy will be much easier to implement, as the availability of high-performance computing and easy upgradeability mean that the software engineering will be much less complex, and therefore cheaper. In this area it will be possible to implement a version of the ASPEN software to automatically schedule upcoming events for the satellite, and reduce a lot of the workload on the operators. This system can take as inputs a number of top-level goals, and combining them with resource constraints, output an optimal solution for the satellite schedule for an upcoming duty cycle.

B.6 Steve Jefferys: GeoSAR, Mission Analysis

The purpose of this Executive Summary is to provide an overview of the findings of the Mission Analysis aspect of the GeoSAR project. It is intended to highlight the salient points regarding the feasibility of this concept from the Mission Analysis point of view.

B.6.1 GeoSAR Concept

The basic idea is to place a passive radar system, detecting satellite transmissions reflecting off the Earth, into a geosynchronous orbit in order to create a synthetic aperture of sufficient size and shape as to achieve a resolution of 100 m. Over time, the path traced out by a moving radar antenna creates a “synthetic” antenna whose size determines the resolution. This will require some eight hours to form an image, and the images may be used in earthquake/volcano monitoring, studies of land subsidence, soil moisture and vegetation cover, among many other applications. It was intended to have three constellations: over America, Europe/Africa, and East Asia, respectively.

B.6.2 Orbit Selection

It was calculated on geometrical grounds that the principle relative orbit (the path of one spacecraft relative to the ground) should be as nearly circular as possible, and 46.19 km in radius. If possible, it was desirable to have a second relative orbit of radius 20 km inside the first one, to cancel some of the sidelobe energy and so improve the signal to noise ratio. The methodology used to locate this orbit was a combination of manual calculation and Satellite Tool Kit simulations.

The starting point was a geostationary orbit which has eccentricity and inclination of zero, resulting in its remaining stationary relative to the ground. If inclination and eccentricity are given non-zero values, the satellite will pursue relative orbits of various shapes. Shown in Figure B.2 is the final constellation, as near as possible to the requirement. The outer pair of spacecraft have $e=0.0005774$ and $i=0.06616^\circ$.

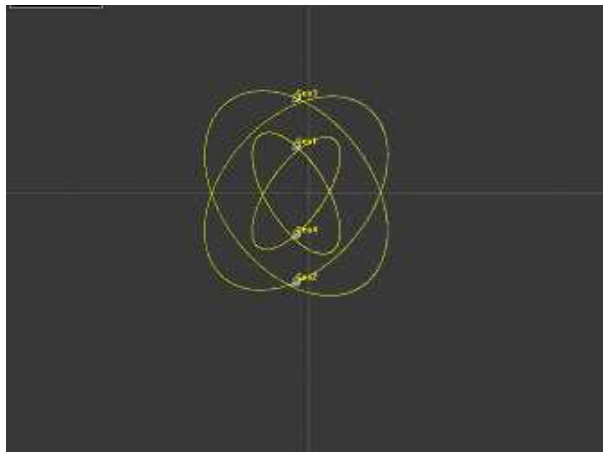

Figure B.2: Final constellation selected for GeoSAR.

The odd shapes of the relative orbits will reduce the uniformity of resolution somewhat, but the sidelobe-cancelling function will still work.

B.6.3 Eclipses

Since the spacecraft derives its power from solar energy, eclipses (both by Earth and Moon) cause loss of power. Their frequency and duration determine the spacecraft's battery capacity. To quantify these, two methods were used: an STK simulation of a year in the life of a GeoSAR spacecraft, with a report printed from it of all eclipses experienced; and a literature study of past GEO satellite experiences of lunar eclipses, which are much less frequent and less regular than Earth eclipses (though often longer). The first is summarised in Figure B.3.

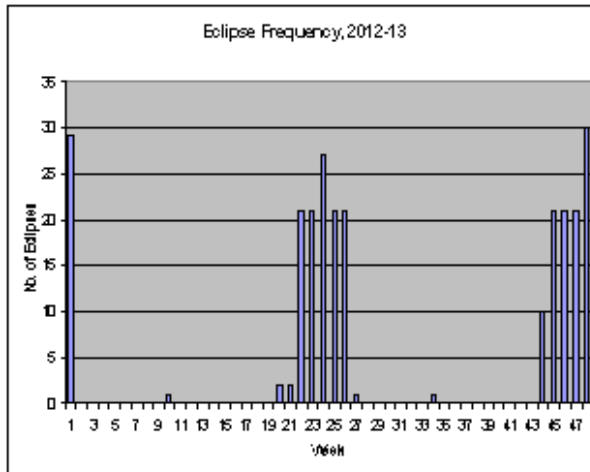

Figure B.3: Results from STK simulation of GeoSAR eclipses over 1 year.

Clearly, the Earth eclipses gather in “clumps” when major events such as launches and orbit changes should be avoided. The battery capacity is designed on a worst-case basis: some lunar eclipses extend for 2.5 hours, so this was the figure used.

B.6.4 Manoeuvres

It is occasionally necessary to move spacecraft around, for example to replace a failed satellite or to move to a commercially more interesting longitude: this could involve either changing relative orbit within a constellation or changing constellation. The manoeuvres required to do this were calculated and checked on STK simulations. To change from inner to outer relative orbit, for example, involves increasing eccentricity and inclination without changing semi-major axis or longitude. This involves two burns (to raise apogee and lower perigee), a third to correct westward drift and a fourth to change the inclination. Total ΔV is 5.051 m s^{-1} . Changing longitude means temporarily placing the spacecraft in an ellipse with a different period; moving west by 165° requires a ΔV of 34.96 m s^{-1} in two burns. An end-of-life move to a graveyard orbit requires 8.1 m s^{-1} in two burns.

B.6.5 Position Finding

For the SAR effect to work, we must know the relative positions of spacecraft within a constellation to an accuracy of 1 cm. Four possible methods were considered: Optical Intersatellite Links (lasers), ground radio ranging, GNSS (satellite navigation) and Autonomous Free Flying sensors. While OISL provides great accuracy, it is mechanically complex and requires more mass and power than other methods. The trade-off is shown in Table B.11.

Table B.11: Position finding technology trade-off. Radio ranging assumes measurements from ground. Notes: (1) radio ranging requires no dedicated equipment on the spacecraft, as it uses the existing communication link; (2) this figure is uncertain, so a conservative value is used.

	Accuracy	Low Mass	Low Power	Cost	Maturity	TOTALS
OISL	5	2	3	2	3	15
Radio ranging	4	5 ⁽¹⁾	5 ⁽¹⁾	3	5	22
GNSS	2 ⁽²⁾	4	4	4	5	19
AFF	4	4	4	4	2	20

Radio ranging won, principally because it requires no specific equipment on the spacecraft, simply using the existing communication link.

B.6.6 Attitude Sensing

A similar trade-off was performed over the best way to sense spacecraft attitude: Sun, Earth and star sensors were all considered. The decision made was to have two wide-angle star-trackers, supplemented and protected from solar exposure by eight Sun sensors.

B.6.7 Conclusions

From the Mission Analysis point of view, there is no fundamental reason why GeoSAR should not go ahead, though further work must be done to establish whether the non-circular relative orbit will give good imaging results.

B.6.8 References

- Agrawal, B.N., Design of Geosynchronous Spacecraft, Prentice-Hall, 1986
- Fortescue, P., Stark, J and Swinerd, G., Spacecraft Systems Engineering, Wiley, 2003
- Lau, K., Lichten, S. and Young, L., An innovative deep space application of GPS technology for formation flying spacecraft, AIAA-96/3819
- Soop, E.M., Handbook of Geostationary Orbits, European Space Agency, 1994
- Wertz, J.R. and Larson, W.J., Space Mission Analysis and Design, 1999

B.7 Mathieu Lesieur: GeoSAR, antennas design

GeoSAR is a passive system that performs imaging of the Earth surface using the signals from other broadcasting satellites reflected on the ground. This project aims at developing a baseline design of a low-cost constellation of passive synthetic aperture radar spacecraft in geosynchronous orbit. The key constraints for the mission are: the low-cost of the mission, the design of a large aperture antenna, the specific almost geostationary orbit, for which the ground track has to be close to a circle with a perimeter of 200-400 km, the 100 m spatial resolution and the 15 years of the mission lifetime. This part of the project focuses on the choice and the design of the antennas required to pick up the reflected signals.

B.7.1 GeoSAR Antenna Definition

Antennas type trade-off

The first task of the Mechanical team was to review the various reflector antenna types that would be suitable to fulfil the mission requirements. Our work was based on Tibert (2002). A large number of deployable antenna structures were analyzed and classified into three different types:

- The solid surface antennas
- The mesh antennas, and
- The inflatable antennas

The information found about fifteen different deployable antennas concepts. These were then merged to perform a preliminary trade-off, to carry out a first selection of the most suitable types of antenna for each mission concept proposed by the system engineers of the project, and thus to reduce the number of options for the GeoSAR antennas. Then a refined trade-off led to the use of inflatable dish antennas.

GeoSAR antenna description

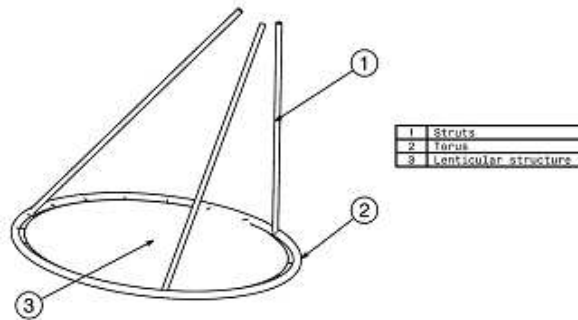

Figure B.4: Description of the inflatable antenna proposed for GeoSAR.

The off-axis inflatable dish antenna for the GeoSAR mission has the following characteristics:

Table B.12: GeoSAR antenna mean characteristics

Aperture (m)	6	Focal length (m)	6.262
Mean reflector diameter (m)	6.65	Offset (m)	0.262
Lenticular structure's volume (m ³)	14.408	Mass (kg)	11.4
Projected lenticular area (m ²)	34.762		

The reflector and the clear canopy of the GeoSAR antennas are made of 6.35 μm thick Mylar[®] films (aluminized for the reflector), as used during the IAE mission. The three struts and the

torus are made of woven graphite epoxy composite material with the heaters needed for the cure embedded between the two plies. A Multi-Layered Insulation (MLI) blanket is surrounding the structure to retain the heat during the cure and to provide thermal protection.

B.7.2 Rigidization Process

For the GeoSAR mission, the choice made was that the three struts and the torus will be rigidized once deployed, and that the lenticular part of the GeoSAR antenna will be maintained inflated during the 15 years of mission time. The choice of the rigidization technique has been made between four processes:

- the UV cure with or without internal radiation,
- the thermal, cure with embedded heaters and
- a chemical reaction between the inflation gas and the composite structure.

The trade-off parameters used were:

- the redundancy introduced aboard the spacecraft;
- the estimated production costs;
- the predictability,
- the controllability and the efficiency of the technique;
- the energy required from the spacecraft;
- the rapidity of the rigidization process; and
- the storage life prior to launch.

According to this trade-off, the most suitable rigidization process for the GeoSAR antennas is the thermal cure of the composite using embedded heaters. As the area to rigidize is 22.45 m² (calculated using the CAD Model of the antenna), the total power needed from the spacecraft to cure the structure was estimated to 340 W per antenna. The cure temperature is 120° C and the cure time is 45 min.

B.7.3 Finite Element Analyses

The two GeoSAR antennas are completely stowed during the launch and the orbit acquisition manoeuvres, and are only deployed once the spacecraft is in its final orbit. As the satellite will orbit the earth, the antennas will experience the torques applied to the spacecraft during the station keeping manoeuvres and the distortions due to the extreme thermal environment of space. Two different finite element analyses were made in order to verify that the antennas would resist to the various interactions from their environment.

The first analysis was made using NASTRAN/PATRAN and aimed to quantify the structural response of a GeoSAR inflatable antenna to typical torques applied to the interface between the struts and the spacecraft. The results of this structural study were very satisfactory: the maximum stresses experienced by the structure are far below the ultimate strengths of the composite material. This is due to the very small loads applied by the very low thrust propulsion system during the manoeuvres in space. Nevertheless, the stresses inside the Mylar® films that composed the lenticular structure were not evaluated, and a more detailed study of these parts might be useful to fully qualified the inflatable antennas structural responses for this mission. The thermal analysis was made using IDEAS - TMG and was performed to have an idea of the distortions of the antennas due to the temperature variations experienced at geostationary altitudes. The temperature variations in the structure (+22° C / -43° C for the struts; +70° C / -145° C for the reflector) imply a maximum deformation of about 0.68 mm for the struts and 24 mm for the reflector. Thus, the composite structure is not really deformed by the heat, but the Mylar films and especially the reflective one are quite distorted due to the high temperature range experienced.

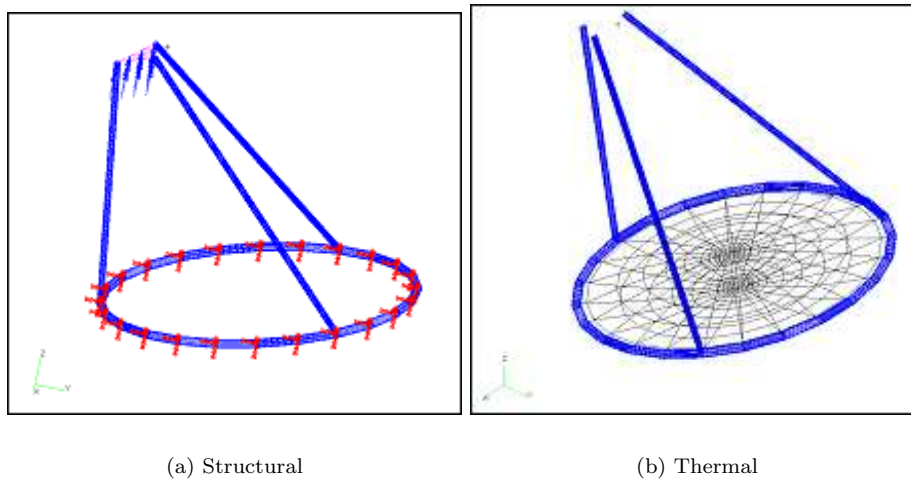

Figure B.5: FE models of the GeoSAR antenna.

B.7.4 Inflation System Determination and Sizing

The deployment of an inflatable antenna is determined by the following steps:

- First, the antenna is released in space, thanks to a small volume of gas provided to the struts and the torus.
- Then, the inflation is carried out until the pressure in the struts and the torus reaches the pressure needed for the rigidization of the structure.
- The volume between the reflector and the clear canopy is then inflated. During this period, the rigidization process of the struts and the torus is performed.
- Once rigidized, the struts and the torus are emptied from any remaining gas.
- The lenticular structure is then vented to a lower pressure, and maintained to this pressure during the mission time, compensating the losses due to micrometeoroid perforations.

The calculations for the sizing of the inflation system were based on the relations established by Thunnissen (1995) for the Pluto Fast Flyby mission and have been applied to the GeoSAR mission. Four different systems were studied:

- decomposed hydrazine (coupled or not with the existing propulsion system), and
- classical Xenon and Nitrogen inflation systems.

A system using the decomposition of the hydrazine (also used for orbit acquisition) into ammonia, nitrogen and hydrogen was chosen. The amount of hydrazine needed to inflate the structure and to maintain the lenticular part of the antenna inflated during the mission lifetime is 8.5 kg.

B.7.5 References

Thunnissen, D., Webster, M., Engelbrecht, C., Low-mass inflation systems for inflatable structures. International conference on integrated micro/nanotechnology for space applications, Houston, TX, October 30 - November 3, 1995.

Tibert, G., Deployable tensegrity structures for space applications. Doctoral thesis, Stockholm, 2002.

B.8 Alex Lucas

This summary is a brief review of the main report detailing the work that was done and the principal findings.

B.8.1 Introduction

GeoSAR is a proposed low cost geosynchronous Earth observation (EO) satellite using synthetic aperture radar (SAR) imaging. The payload system is unique in that it exploits spaceborne “illuminators of opportunity” for passive coherent location (PCL). Hence signals illuminating the Earth for purposes of communication, broadcast, navigation, etc. are used as the transmitter signals, and GeoSAR is the bistatic or multistatic receiver of these signals. This means that conceptually GeoSAR, as a passive radar system, is much simpler than conventional spaceborne radar, as it only has to do half the work; and as such has potential for low system cost and mass.

It has been shown (Prati et al., 1998) that a GeoSAR system using a 5 m receiving antenna, with L-band digital audio broadcasting (DAB) as the illuminator of opportunity is theoretically feasible from considering radar theory and the signal path link budget. However the GeoSAR payload subsystem design will be investigated from the view point of space systems design, using this as the baseline system.

B.8.2 Choice of application

Frequency requirements

There are literally hundreds of spaceborne satellites illuminating the Earth from which the GeoSAR system could receive the backscattered radiation. The choice of “illuminator of opportunity”, be it (DAB), GPS, or even other SAR radar (Runge et al., 2001), will among other things provide the frequency band to be used for the SAR. It was found through research that this choice of frequency is important as it affects the choice of applications that the SAR can perform. For instance short wavelength X-band microwaves are useful for mapping vegetation type, whereas long wavelengths like L or P band are optimal for mapping soil moisture because of the penetration through the layers of ground vegetation.

Other applications relating to interferometric synthetic aperture radar (InSAR) were also investigated, as this was identified as

1. an application area which isn't being fully made use of by current space missions,
2. is useful for the science community, as well as for commercial and humanitarian reasons, and
3. an application area which GeoSAR could be made to perform well in. InSAR applications include understanding of plate tectonics, 3D mapping of surface topography, and earthquake and volcano monitoring, or disaster management.

In terms of the application areas affecting the GeoSAR concept design; geophysics and surface deformation has simple frequency requirements at L-band, whereas many ecology applications require multiple frequencies and polarisations.

B.8.3 Spatial and temporal requirements

Comparisons of the requirements for some of the applications of SAR are shown in Figure B.6. This shows the temporal frequency range (how often an image is needed), e.g. disaster monitoring was identified as being the most demanding in terms of the temporal frequency, in the order of a few days. This is plotted against the requirement for spatial resolution, both on a log scale for easier comparison. For instance biomass estimation, a useful parameter for the carbon cycle and climate change requires measurements over huge areas (low resolution requirements) of tropical and boreal forests over long time scales, hence to reduce the data quantities involved imaging every day would not be useful, therefore both temporal and spatial requirements are low (top right). In this case a more important requirements would be in terms of the coverage required, i.e. large areas of the Earth as well as at high latitudes.

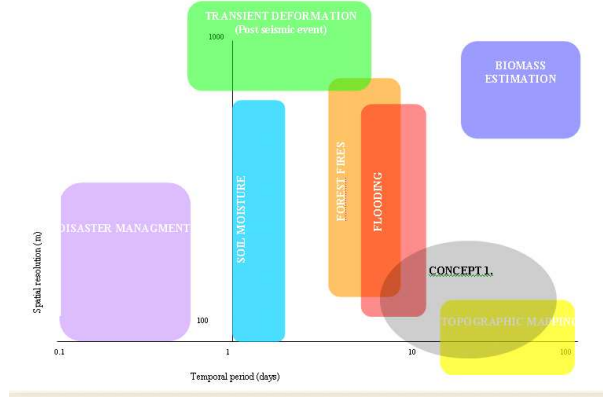

Figure B.6: Overview of possible SAR applications.

B.8.4 Payload sizing and simulation

Before the performance of different GeoSAR designs could be analysed it was necessary to have parameters which could be used for the tradeoffs. Hence some formula were derived as follows

Signal to noise ratio (SNR)

SNR can be influenced by the resolution required (L), the GeoSAR antenna diameter (D), and the time required to get an image, or observation time (T). It is also affected by choice of frequency band as the surface reflectivity (σ^0) increases with frequency; this is because the surface will appear rougher at shorter wavelengths. SNR can be rewritten as

$$SNR \propto CL^2D^2T \quad (B.1)$$

$$SNR = \left(\frac{EIRP_T \sigma^0}{64\pi S^4 k T_S} \right) L^2 D^2 T$$

C can generally speaking be called a constant, which can be calculated from the transmitter equivalent isotropic radiated power ($EIRP_T = 57$ dBW), the slant range ($S \sim 36500$ km) distance from the target area on the ground to the satellite, and the noise due to the hot Earth, with antenna noise temperature ($T_S = 290$ K) and where (k) is Boltzmann's constant (1.38×10^{-23} J K⁻¹). With ($\sigma^0 = -18$ dB) $C = 3.86 \times 10^{-9}$ W m⁻⁴ K⁻¹.

$$SNR(dB) = 10 \log(3.86 \times 10^{-9} L^2 D^2 T) \quad (B.2)$$

Hence for a spatial resolution of 100 m and observation time of 8 hours the SNR at the GeoSAR receiver is 18 dB, which is adequate for a passive radar system. The observation time is approximated by considering the diffraction limited resolution of the system. Linking the resolution required (L) to the SAR aperture length (A), where the wavelength of the system is ($\lambda = 0.2$ m).

$$T = \frac{\lambda S}{LV} \quad (B.3)$$

Antenna size and coverage

The coverage on the ground is calculated from the footprint diameter (F), which is related to the antenna size (D) by

$$F = \frac{\lambda S}{D} \quad (B.4)$$

The chosen antenna diameter from a trade off of the SNR and the coverage was 6 m giving a footprint area of about 1 million km². This means on a continental scale e.g. for Africa, ~25 spots are needed. With a chosen feed system consisting of a microstrip feed array of 15 patches (each patch receiving signals from a separate footprint on the ground), the coverage is vast. For 2 spacecraft at a longitude of 25° the whole of Europe and Africa can be viewed at any time.

B.8.5 Conclusion

A number of concepts were defined for the GeoSAR project, for instance using very high inclination orbits to get polar coverage, or using single pass interferometry with a two satellite formation. From areas of research (1) GeoSAR applications and (2) payload parameter simulation, the performance of the concepts could be investigated. For instance the black circle (Concept 1.) shown on Figure B.6 is the InSAR topographic mapping concept, and the associated temporal and spatial resolutions. Hence it has good spatial resolution, from having the two satellites (separated by the interferometric baseline of 1 km at L-band) doing single pass interferometry, but has poor temporal resolution. It can be seen clearly that in relation to this concept if the black circle moves left the mission becomes harder to achieve in terms of temporal requirements, and as the circle moves up the spatial resolution requirements are relaxed. A summary of the mission is shown in Table B.13.

Table B.13: GeoSAR payload objectives

Low cost mission	<€500M
Proposed launch date	~2020
Lifetime from GEO	~15 years
Orbit determination	to allow InSAR from repeat images
Pointing accuracy	4°
Minimum spatial resolution	100 m
Coverage: near-global	All latitudes within ±50°
Receiver frequency	L-band, 1.5 GHz
Revisit time (disaster management)	6 hours

B.8.6 References

- Prati C. et al. (1998), Passive geosynchronous SAR system reusing backscattered digital audio broadcasting signals, IEEE Trans. Geosci. Remote Sensing, vol. 36.
- Runge H. et al. (2001). The interferometric cartwheel for envisat. In: IAA Symposium Small Satellites For Earth Observation, H. P. Rser, R. Sandau, A. Valenzuela, Eds., Berlin 2001, pp187 - 190.

B.9 James Marshall

B.9.1 Introduction

The main objectives of the Electrical Sub-System Design work package were to design an electrical power system that would be reliable for 15 years, relatively light and inexpensive and capable of handling GeoSAR's power requirements. GeoSAR's power requirements have to be switched regularly between its primary and secondary power sources due to eclipse periods. Designing a power system capable of operating reliably over many years and at a relatively inexpensive cost was the main driver for the power sub-system. The main driver of the communications system was Verification that a downlink was possible by means of a link budget.

B.9.2 The Electrical Power system

The electrical system is made up of two solar arrays, their drive motors, two batteries, a PCU, and any required DC to DC converters. Designed to maintain reliable satellite power at all times including eclipse periods. The Earth eclipse season due to the Earth's axis angle relative to the sun is approximately from Feb 26 to April 13, and Aug 31 to Oct 16, they last up to 71.5 min. Eclipses due to the Moon happen one to five times per year and last up to 2.5 hours, but this is extremely rare. The electrical system is designed for a worst case scenario to be able to withstand both of these eclipses within the same orbit, as GeoSAR uses a radar system that is capable of taking images during these eclipse periods. GeoSAR also is required to do 2 hours of orbit correction manoeuvres each orbit. It does this using FEED thrusters designed by Gavin (2006) which only require 10 W each to operate. As the power requirement of this orbit manoeuvre is so low it can also be done during a normal eclipse period. Extra power is generated by the solar array for redundancy reasons, and because at some points during the orbit the solar arrays are partially shadowed by the radar antenna dishes, which are 6 m diameter each designed by Lesieur (2006).

A range of power generation systems was considered for GeoSAR, the only feasible ones were solar panels and batteries, or RTG's. RTG's overall worked out to be around 10 kg heavier than the solar panels and batteries, and would be a political disaster so they were dismissed. From this, further research was put into different types of solar arrays and secondary batteries. L'Garde's solar arrays were chosen due to their high power to weight ratio, and Li-Ion secondary batteries were chosen for the same reason as cost is the main mission driver.

B.9.3 Power system requirements

- Be able to raise 450 W during sunlight and 215 W during eclipse periods
 - Using two 500 W L'Garde inflatable arrays
- Store the power in the batteries for the eclipse periods
 - Uses two Li-Ion 34 Ah batteries
 - Full charge time of 11 hours
 - Capable of powering the satellite during eclipse period in a worst case scenario
- Be reliable over a period of 15 years
 - Battery and solar arrays have built in 3 % degradation per year
 - Can supply power for a worst case eclipse of 2.5 hours on one of its two batteries, discharging it up to 85 % DOD, and be fully charged for a second eclipse in 11 hours without using high speed charging
- Be adaptable for different system voltages
 - DC to DC converters have been researched and are small light inexpensive and relatively powerful
 - Normal bus voltage regulated at 28 V

- Survive launch
 - All components in the electrical sub-system, except for the solar arrays have been space qualified
- Regulate the power
 - This is done using an off-the-shelf PCU
 - The PCU is of similar design to the one used on Meteosat. This is because it is designed for a long mission duration and hence has lots of redundancy.
 - Excess power is shunted through dump resistors on the external surface of the satellite
- Provide power to the communication system during an emergency
 - This is done using the extra power stored on the batteries for worst case scenarios

B.9.4 Solar panels

The L'Garde solar arrays chosen are unique as they are deployable using an inflatable structure. They are a new type of technology that is being explored due to advances in material technology. The only part that is inflatable is the booms on the side of the solar array film, which serve to stretch the film out of its stowed configuration. Once the booms are inflated they will rigidize over several hours due to heat from the sun or over a 45 min period using internal heaters, which require 150 W of power per solar array. It has been decided that the internal heaters would be used as this will minimise the inflation gas required, as punctures in the booms can occur during the rigidization process from micro meteorites. As inflatable technology is also being used for the radar antennas done by Lesieur (2006), the same gas and tank will be used for all of the systems to minimize weight required. Even though the solar arrays produce a 1 kW once deployed and are large, the mass for both of them comes to only 8.7 kg.



Figure B.7: Picture of L'Garde's 500 W solar arrays once inflated [L'Garde, 2003].

B.9.5 Batteries

The chosen batteries for the mission are Li-Ion batteries due to their high power density compared with other secondary battery types as shown in Figure B.8. These batteries do not significantly lose charge storage over their lifetime, and can withstand thousands of charge cycles that do not have excessive DOD. During the GeoSAR mission unless there is a battery failure the batteries will not discharge past 55 % DOD.

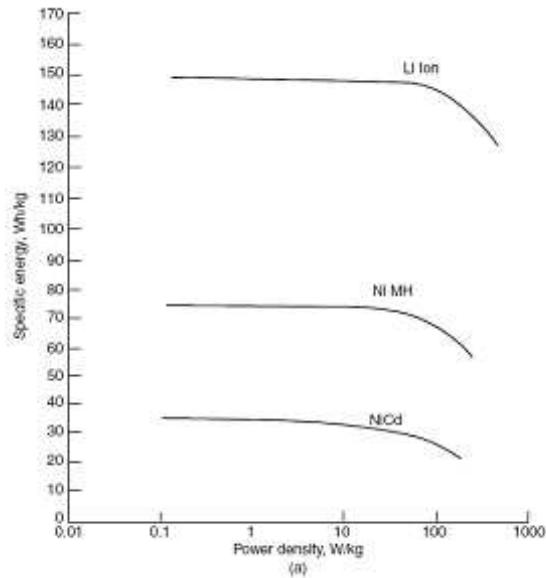

Figure B.8: Graph shows specific energy vs. power density for some secondary batteries types [Lindon, 2002].

B.9.6 Link budget

The frequency that the radar antennas are receiving are DAB signals in L-Band which are at a frequency of 1.5 GHz. These signals have a bandwidth of 4 MHz. These received signals therefore require 4 Mbits/s for each polarisation. Using this plus housekeeping data the estimated data rate per spot beam is 10 Mbits/s. Therefore the link budget per spot beam came to 10 dB. It was decided that to accommodate the other spot beams it would be sensible to spread this data rate across a frequency of 12 GHz using FDMA or CDMA as the signals have to be kept separate anyway. This also makes turning off unnecessary spot beams, such as ones looking at oceans, much simpler.

B.9.7 Conclusion

The whole electronic system met the power requirements set out by all of the sub-systems. The system also fulfills the mission requirements by choosing the lightest components possible, except for the PCU which is constrained by the other mission requirement to be reliable over 15 years. Future work includes, designing a GeoSAR specific PCU to increase its mass efficiency

B.9.8 References

Gavin, M., (2006) GeoSAR: AOCs Design. GDP Report, Cranfield University.
Lesieur, M., (2006) GeoSAR: Antenna Design. GDP Report, Cranfield University

B.10 Frederic Wanat: GeoSAR Mechanical Subsystem

B.10.1 Introduction

The GeoSAR project is a feasibility study of a low cost mission based on a constellation of satellites passively imaging the Earth thanks to the reflected signals broadcasted by other satellites. The main objective is to have a mission doing the same work as similar LEO mission but which is less expensive. The constellation will be able to perform for 15 years imaging of soil moisture or disaster monitoring with a spatial resolution of about 100 m. The final constellation is composed of 12 satellites placed in geosynchronous orbit doing interferometry 2 by 2 to image the Earth. The work presented here is part of the work done by the mechanical subgroup. It is divided in 2 distinct parts:

- the choice of the antenna
- the configuration of the satellite

B.10.2 Choice of the antenna

Objectives and methodology

The antenna is the key part of the payload. Due to the very low power of the signals reflected from the ground, it has to be huge. It has to comply with the customer requirements which are mainly a lifetime of 15 years and a low cost. The mass and the volume also have to be as low as possible and the system has to be fully reliable as it is critical to the mission. The objective was to identify the possible antenna concepts and their key parameters and then to choose an antenna and its deployment system. The methodology has been first to collect as much information as possible on the different antennas used by the space industry, then to cross-reference it and merge the data together. From this it has been possible to find the relevant concepts and to define their main characteristics (e.g. mass, volume). Finally a trade-off has been performed depending on the requirements of different concepts of missions so that it was possible to choose what was believed to be the best antenna whatever the baseline of the mission was.

Deployable antennas

For this part most of the data come from the doctoral thesis of Gunar Tibert entitled Deployable tensegrity structures for space applications (ref [1]). Deployable structures capable of large configuration changes from a stowed position to an operational position are well developed in the space industry. GeoSAR will contain a large antenna using such technologies. Most of the existing deployable antennas can be listed into 3 categories:

- Mesh antennas: it is the most common concept of deployable antenna. They are composed of a discontinuous knitted lightweight mesh
- Solid antennas: those antennas have a very high surface accuracy but they have complex mechanisms and a high mass limiting the diameter
- Inflatable antennas: they have potentially the lowest mass and the smallest stowed volume. Composed of thin flexible materials, they are folded prior to launch and inflated in space, the structures can be rigidized by curing a resin.

Trade off

From the data collected a trade-off with four parameters (mass, stowed volume, reliability and stiffness) has been performed. Then 9 concepts of mission have been defined by the system engineers. For each mission, weightings have been placed on the parameters. Whatever the mission could be, there was always a best choice of antenna. Finally the concept of inflatable antenna has been chosen. Mathieu Lesieur from the mechanical team has been in charge of developing the 6 m diameter antenna for the rest of the project.

B.10.3 Configuration

The configuration process began at the midterm of the project. The objective of this part was to provide a suitable configuration for the spacecraft and to provide the other subsystems with the information they needed on the shape or the mass of the spacecraft or the location of the components. This work had to be a basis for the development of the structure and the refinement of the spacecraft

The process

Mainly the process of configuring the spacecraft is the method advised in the book *Spacecraft Structures and Mechanisms* written by T. P. Sarafin and W. J. Larson (ref [2]). This is an iterative process which begins with collecting data about the mission. Then the choice of the launcher determines the envelope of the stowed configuration. From the mass budget developed by the system engineers, a list of component with their characteristics is created. It is then possible to develop a configuration with the requirements of the different subsystems and to arrange the components on a CAD model. This model produces layouts of the stowed and deployed configuration as well as the mass properties and the nomenclature. Then the model has to be refined as the project and the requirements evolve.

The Soyuz launcher

Due to the mass constraints, it is possible to fit 3 spacecrafts at the maximum per Soyuz launch. It has then been decided to use an S fairing as the volume available was big enough for three spacecrafts. With the Soyuz it is possible to use the Fregat upper stage like an orbital vehicle to reach an orbit close to the final orbit. Then the fairing has been divided in three from a top view (like a cake). Each satellite is using 2 antennas which can be attached on the side of the satellite. The three satellites of a launch have to be attached to a mechanical structure that makes the junction with the Fregat. This dedicated structure is called a dispenser. It does not only physically support the satellites but it is also used to separate them on their respective orbits, to route the electrical cables from the launcher to the satellites and to contain the sensor used to monitor the flight environment. This structure is directly provided by Starsem as part of its launch services agreements (see ref [3]).

The configuration

The satellite contains the following components (Figure B.9).

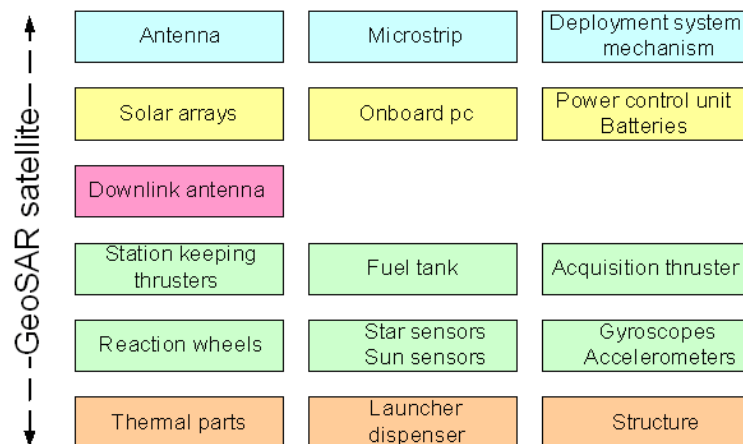

Figure B.9: GeoSAR components

The components have been arranged logically. First the best location for the payload has been decided. Then the position of the deployable or the large structures such as the inflatable solar

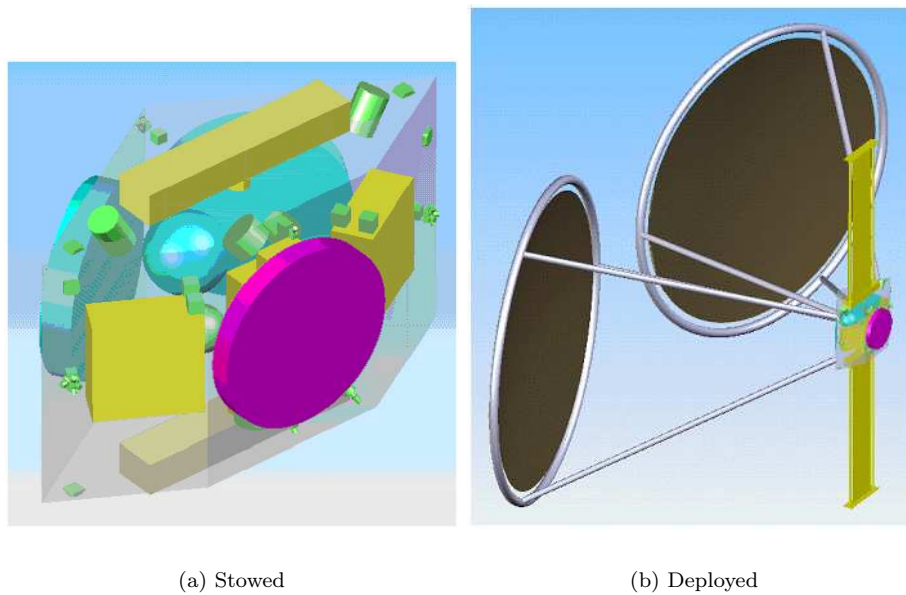

Figure B.10: GeoSAR spacecraft stowed and deployed configurations.

array has been decided (top and bottom). The downlink antenna has been placed so that it can always face the Earth. The electrical components have been mounted on external walls and the heavier components have been placed as close to the dispenser as possible. The configuration of the thruster has been decided in collaboration with the AOCS team to be efficient and so that it cannot contaminate the antennas. The sensors have been placed to allow the navigation and positioning and so that they can never be shadowed by other components. Most of the elements can be arranged on shelves. This configuration leaves a lot of free space for the tubes and panels of the structure. The nomenclature has been produced and the mass properties of each configuration have been calculated. Each satellite weight about 320 kg. The centre of mass is located on the symmetry axis of the spacecraft and in the middle of its height. The inertia of the deployed configuration are between 683 kg.m^2 and 1002 kg.m^2 .

B.10.4 References

- [1] Deployable tensegrity structures for space application. Gunnar Tibert. Doctoral thesis. Stockholm 2002.
- [2] Spacecraft structures and mechanisms : from concept to launch / Thomas P. Sarafin, editor; Wiley J. Larson, managing editor. Torrance, CA: Microcosm; Dordrecht: Kluwer Academic Publishers, 1995.
- [3] Soyuz user's manual, Starssem, Issue 3 Revision 0, April 2001.