



*IWASRI*



# **WaSim Tutorial Manual**

This manual is an output of Project R6879, funded by DFID under the Knowledge and Research (KAR) Programme. The work was undertaken by HR Wallingford and Cranfield University (at Silsoe), with the active participation of the International Waterlogging and Research Institute (IWASRI), Pakistan.

The DFID KAR Project details are:

Theme:	W5 – Improved availability of water for sustainable food production and rural development.
Project title:	Aids to Improved Agricultural Development
Project No:	R6879

This document is an output from a project funded by the UK Department for International Development (DFID) for the benefit of developing countries. The views expressed are not necessarily those of DFID.

Authors; Tim Hess (Cranfield University)

19 October 2000

HR Wallingford  
Howbery Park  
Wallingford  
Oxfordshire  
OX10 8BA  
UK

Institute of Water and Environment  
Cranfield University  
Silsoe  
Bedford  
MK45 4DT  
UK

<http://www.hrwallingford.co.uk/>

<http://www.silsoe.cranfield.ac.uk/>

© HR Wallingford, 2000

## Contents

<b>Tutorial.....</b>	<b>1</b>
1 Introduction.....	1
2 Running the program.....	2
3 Running the model.....	5
4 Viewing results.....	6
5 Modifying the irrigation schedule.....	7



# Tutorial

## 1 Introduction

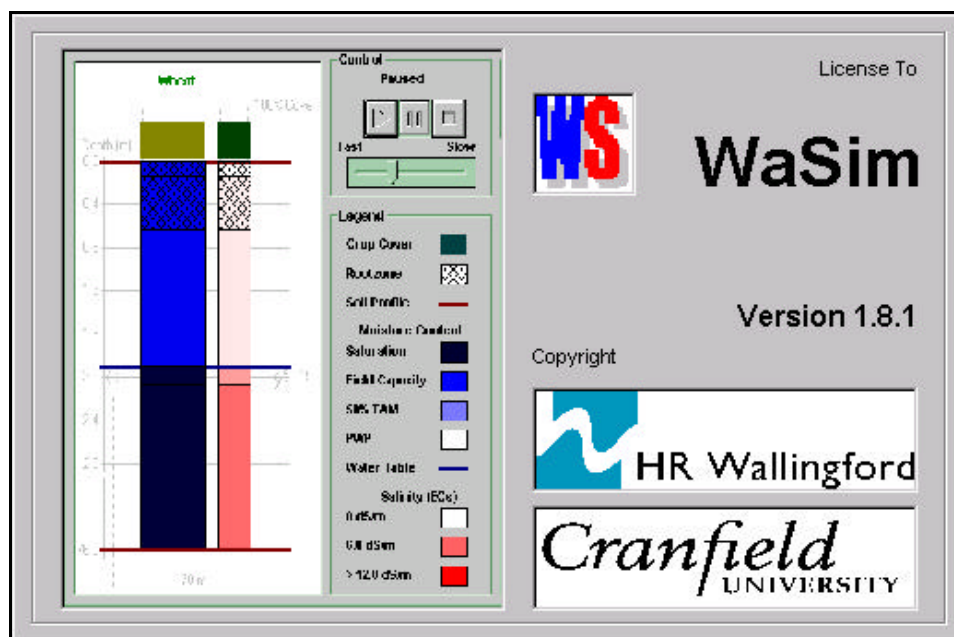

The *WaSim* model is a one-dimensional daily soil water balance model developed by Cranfield University and HR Wallingford to simulate changes in root zone soil water content and watertable position in response to weather and water management.

The program uses a three-layer soil water balance model to estimate the changes in the soil water content on a daily basis taking into account inputs of rainfall (and irrigation) and outputs of evapotranspiration (modified for the crop cover and soil water status) and deep percolation. The deep percolation forms the input into a watertable model which can include the impact of a field drainage system.

To run, the model requires a time series of daily rainfall and reference evapotranspiration data. This can be imported from a text file. In addition, the crop and soil parameters (and irrigation and drainage) need to be defined.

- Crop parameters: These define the growth cycle of the vegetation over the year, the rooting characteristics and the crop coefficient for evapotranspiration.
- Soil parameters: these define the soil profile depth and water holding characteristics

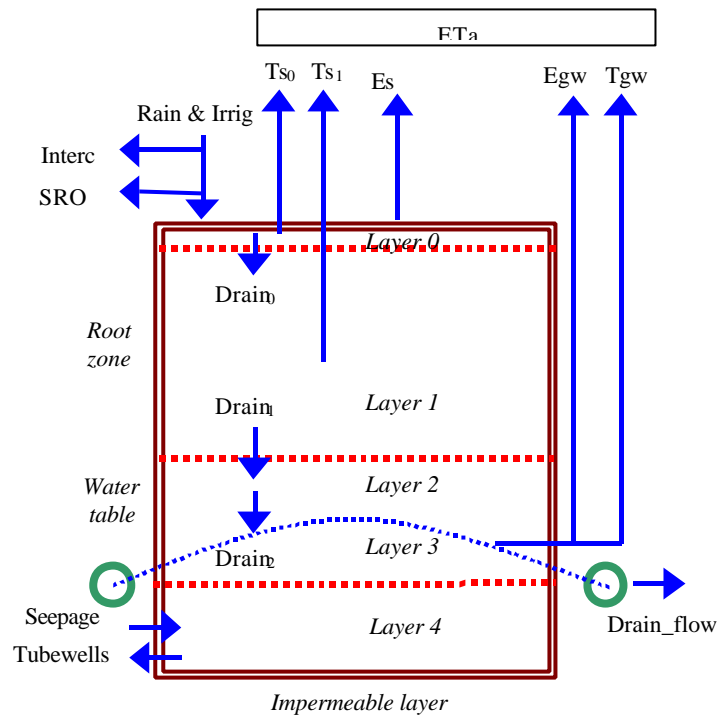

**Figure 1 Schematic representation of the WaSim model**

## 2 Running the program

### **Setting the operation mode**

WaSim is a very flexible programme that can be used in many different ways. Before starting this exercise, select **Options, Operation mode** and set the following (Figure A.2);

- User level to 'normal access'
- Irrigation option on (checked)
- Watertable and salinity options all off (unchecked).
- Display options to 'full display'.

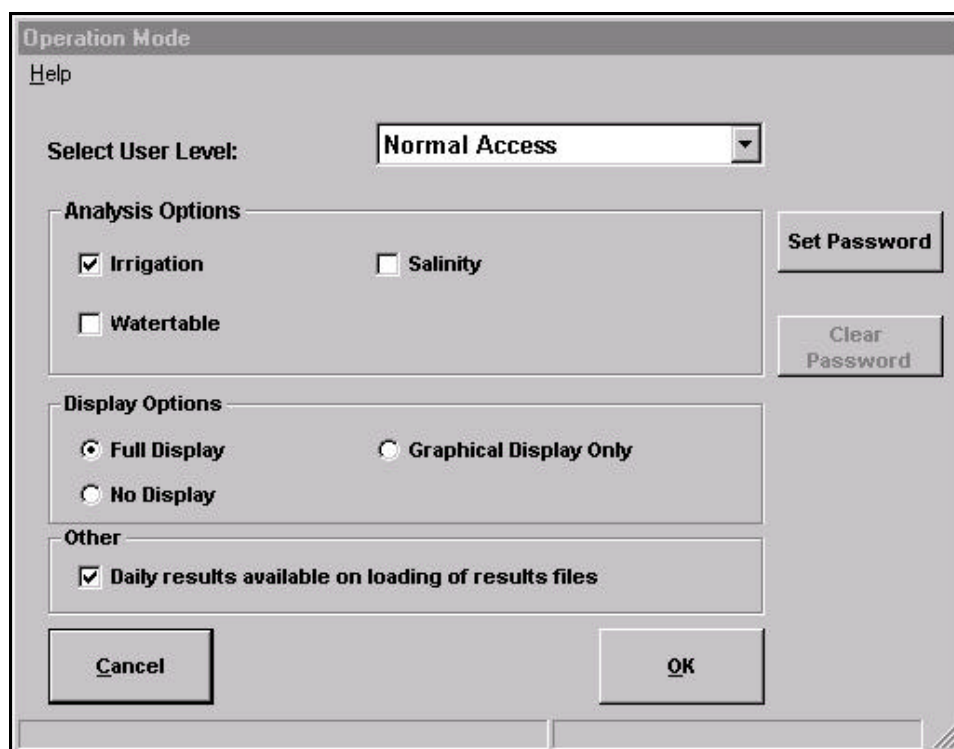





Figure 2 Operation mode settings.

## Setting up

### Soil data

Soil parameter files have been created for 11 typical soil textures. To select a soil type click on  or **Soil Data** and select the required soil type. For this example select a sandy loam soil.

### Weather data

The file SILSOE.CLD contains daily rainfall and reference ET for the period 1/1/78 to 30/9/98 for Silsoe Campus, Bedfordshire, UK. To select the weather data file click on  or **Climate Data** and  to locate the met data file.

### Crop data

Crop parameter files have been created for three surfaces;

- Permanent grass.
- Main-crop potato crop (May to August) with the winter fallow.
- Bare soil.

To select a crop click on  or **Crop Data (1)** and select the crop type. For this example select Potatoes. Note. Up to three crops can be selected in a rotation if required.

***Irrigation plan***

To select an irrigation plan click on  or **Irrigation Crop (1)** and select the irrigation plan. For this example use the ‘standard potato plan’.

***Run parameters***

Before the model can be run, details of the initial conditions and length of run need to be set. Click on  or **Run parameters**

1. Dates: Set the model to run from 1 April<sup>1</sup> 1995 to 30 September 1996 (i.e. the 1996 Water Year with a 6 month ‘lead in time’). Set the date for ‘summary results’ to 30 September.

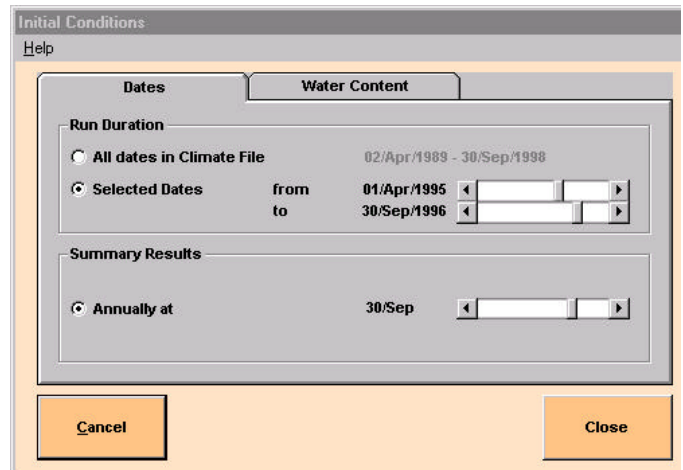

2. Water Content: Set the initial water content to field capacity.

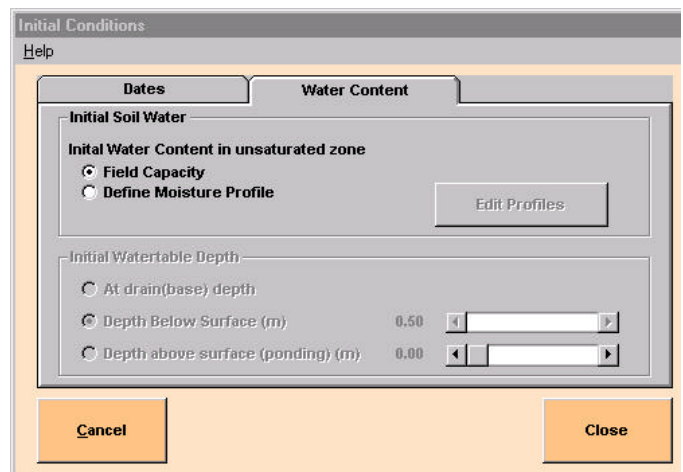

### 3 Running the model

To run the simulation click on  or select **Run** from the **Analysis** menu.

#### **Analysis screen**

When you start the model simulation, you are presented with a graphical animation screen (Figure A.3). To start the simulation click on the start button, .

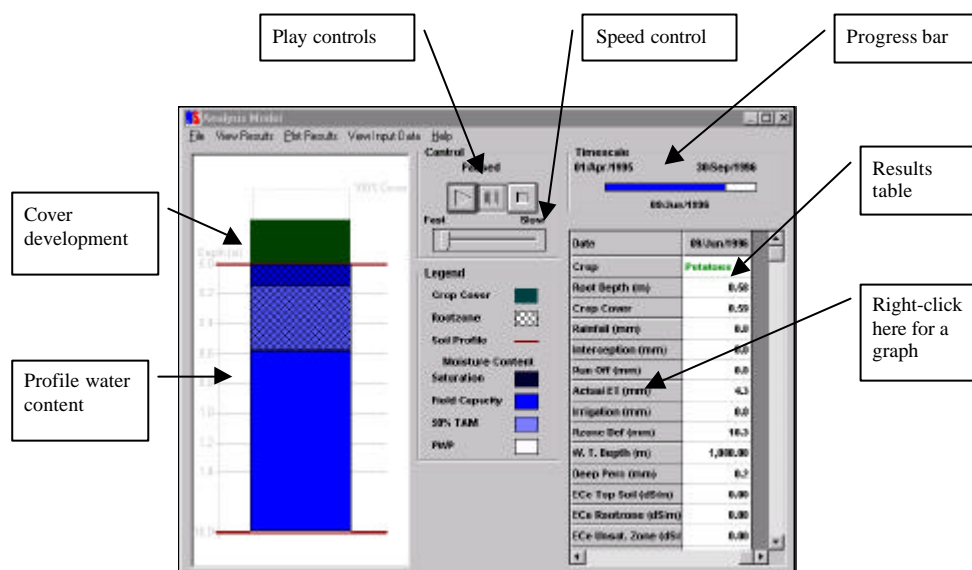

**Figure 3 Graphical animation screen.**

- The model run can be paused at any time by clicking on the pause button .
- The speed of the simulation can be changed.
- The results table can be scrolled back in time to view historical results.
- A graph of any output parameter can be viewed by right-clicking on the parameter name on the results table.

#### **Saving results**

When the simulation is completed, you will be prompted for a name for the results file. Select a name that clearly identifies the run. E.g. SLPOTS to denote sandy loam soil and potatoes.

## 4 Viewing results

To open a results file for viewing, click on **Results, Add/import results file** and select the appropriate file. Note that up to five results files can be opened at once to allow results to be compared and overlaid.

### Results summary

To view a summary of the results click on  or select **Results, View summary results**. You will be asked to select which run you want to view, and whether you want a **seasonal** (crop season), **monthly** or **annual** summary (Figure A.4). The annual summary refers to years as specified in the summary date above.

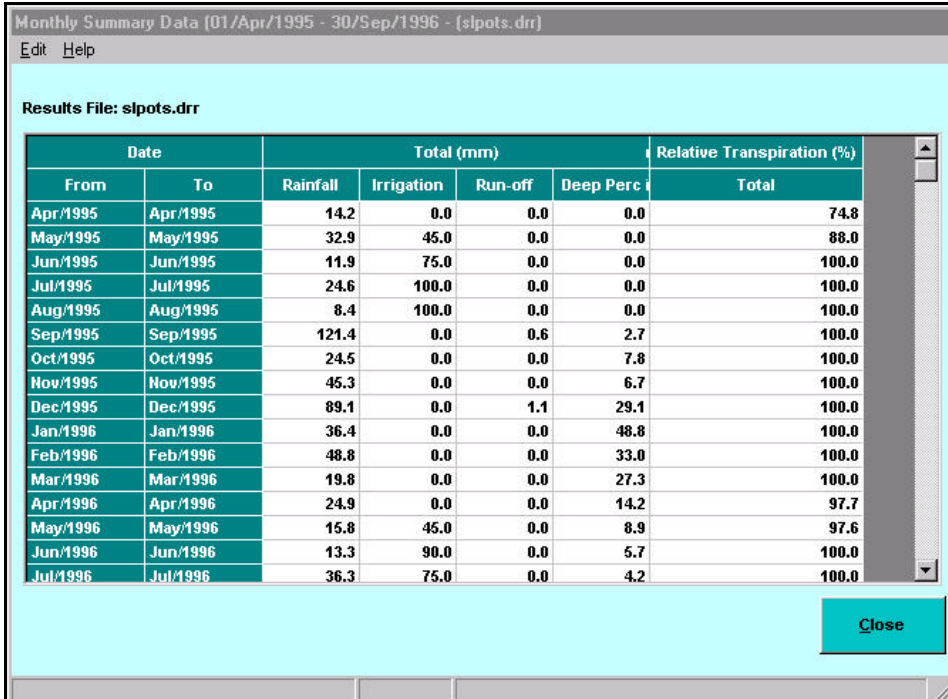

Monthly Summary Data [01/Apr/1995 - 30/Sep/1996 - (slpots.drr)]  
 Edit Help

Results File: slpots.drr

Date		Total (mm)				Relative Transpiration (%)
From	To	Rainfall	Irrigation	Run-off	Deep Perc	Total
Apr/1995	Apr/1995	14.2	0.0	0.0	0.0	74.8
May/1995	May/1995	32.9	45.0	0.0	0.0	88.0
Jun/1995	Jun/1995	11.9	75.0	0.0	0.0	100.0
Jul/1995	Jul/1995	24.6	100.0	0.0	0.0	100.0
Aug/1995	Aug/1995	8.4	100.0	0.0	0.0	100.0
Sep/1995	Sep/1995	121.4	0.0	0.6	2.7	100.0
Oct/1995	Oct/1995	24.5	0.0	0.0	7.8	100.0
Nov/1995	Nov/1995	45.3	0.0	0.0	6.7	100.0
Dec/1995	Dec/1995	89.1	0.0	1.1	29.1	100.0
Jan/1996	Jan/1996	36.4	0.0	0.0	48.8	100.0
Feb/1996	Feb/1996	48.8	0.0	0.0	33.0	100.0
Mar/1996	Mar/1996	19.8	0.0	0.0	27.3	100.0
Apr/1996	Apr/1996	24.9	0.0	0.0	14.2	97.7
May/1996	May/1996	15.8	45.0	0.0	8.9	97.6
Jun/1996	Jun/1996	13.3	90.0	0.0	5.7	100.0
Jul/1996	Jul/1996	36.3	75.0	0.0	4.2	100.0

Close

Figure 4 Example of the monthly results display.

The summary table gives information on rainfall, irrigation, run off, deep percolation and relative transpiration. The relative transpiration is a measure of stress (both from water deficit and water excess) and can be used to estimate the impact on yield.

### Plot results

The results can be plotted (graphed) on the screen by clicking on  or selecting **Results, Plot results**.

- x-axis. Select Date for the x-axis.

- y-axis. The y-axis can display daily or cumulative results for any of the parameters calculated by the model. For this example select daily results for root zone soil water deficit.
- Click on  to display the graph (Figure A.5).

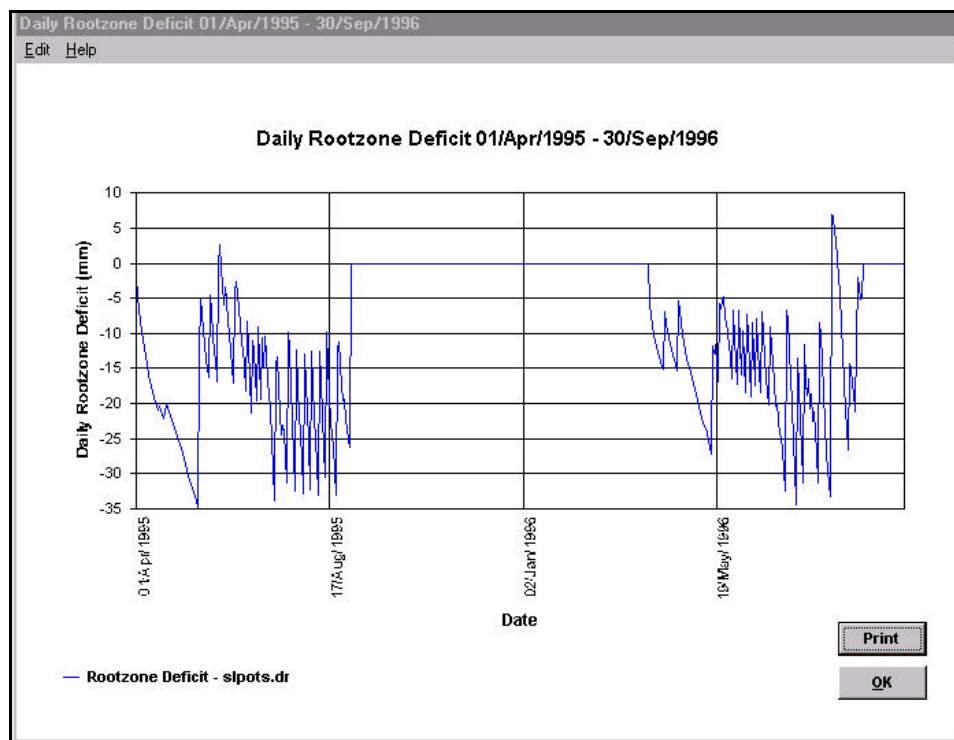

NB. there is no root zone deficit during periods when there is no crop in the ground!

**Figure 5 Daily plot of root zone soil water deficit**

## 5 Modifying the irrigation schedule

To modify the irrigation schedule

- Click on  or **Irrigation Crop (1)** and select the irrigation plan.
- Click on **Edit**.
- 

### *Irrigation periods*

The crop season can be divided into a number of ‘periods’ during which different rules are applied (Figure A.6). For each period you can define;

- The end of the period (Finish date). The first irrigation period begins at planting. Each following period starts when the pervious period finishes. Any time between the end of the last period and harvest is assumed to be un-irrigated.

- The rule for timing of irrigation
- The rule for how much to apply.

**Figure 6 Scheduling rules for Irrigation Period 2.**

### **Other**

- Pre-irrigation: Allows an irrigation to be scheduled for a fixed date prior to planting.
- Rainfall / interception: Allows the irrigation plan to be suspended if a given amount of rain falls, and set whether irrigation is subject to interception losses.
- Water salinity / flow rate: Specify salinity of irrigation water (for salinity simulation) and limit the system capacity.

**Figure 7 Other irrigation options. Long simulations**

The graphical animation and results table slow down the execution of the model. For long simulations it may be better to disable these and simply view the results file. To disable them select **Options, Operation Mode** and check the **No display** box. Also the graphing 'engine' is very slow and for long simulations it may take a long time to plot the graph on the screen. For long simulations it is usually adequate to plot monthly averages.

# Wasim - Tutorial Manual

Hess, Tim M.

2011-01-14

---

<http://dspace.lib.cranfield.ac.uk/handle/1826/4728>

*Downloaded from CERES Research Repository, Cranfield University*