

Monitoring cure in epoxies containing carbon nanotubes using an optical fibre Fresnel refractometer

Athanasios Dimopoulos^a, Stephen J. Buggy^b, Alexandros A. Skordos^a,
Stephen W James^b, Ralph P. Tatam^b and Ivana K. Partridge^{a,*}

^a*Composites Centre, School of Applied Sciences, Cranfield University,
Bedford, MK43 0AL, UK*

^b*Engineering Photonics Group, School of Engineering, Cranfield University,
Bedford, MK43 0AL, UK*

Abstract

Fresnel refractometry was utilised to follow the changes in the refractive index during isothermal cures of a simple difunctional epoxy resin, of a commercial formulated multifunctional epoxy blend (MTM 44-1) and of the same two resins systems modified by the addition of multi-walled carbon nanotubes. The refractive index change, monitored via an embedded optical fibre, was correlated with the degree of cure established from isothermal DSC measurements. A good correlation was established in all cases, indicating the potential of the technique to be used for online cure monitoring in thermosetting nanocomposites.

Keywords: cure monitoring; nanocomposites; Fresnel refractometer

Introduction

* Corresponding author: Building 61, Department of Materials, School of Applied Sciences, Cranfield University, Cranfield, Bedfordshire, MK43 0AL, United Kingdom, Tel: +44 1234754153,
E-mail address: i.partridge@cranfield.ac.uk

The use of the refractive index as an indicator of the extent of cure in organic thermosetting resins has been reported by several authors [1-4]. The technique has been established as being suitable to follow the changes from the liquid to the solid state, in situ, in both resins and fibre reinforced composites [5,6]. The question arises whether it is still a suitable monitoring technique if the resin is modified by the addition of a relatively low concentration of a nano-scale additive, such as carbon nanotubes (CNTs). Thermosetting nanocomposites are in the stage of passing from the laboratory to real applications [7-10] and thus the need to be able to follow how they cure is likely to arise in the very near future. At present dielectric cure monitoring is the best established of the potential on-line techniques [11] but the highly electrically conductive nature of the CNTs is a contra-indicator for its practical application in such compounds. In light transmission terms, even a very low concentration of CNTs will make the resin completely opaque, thus ruling out other monitoring options such as infrared spectroscopy. The Fresnel refractometry technique utilised in this study [4,6] probes the interface between the end of the embedded optical fibre and the curing resin and thus has the potential to be unaffected by the presence of the CNTs while still being sensitive to the changes taking place in the resin while it cures.

Experimental

Epoxy resins and their nanocomposites

The simpler of the two epoxy resin system utilised, which could be considered as a laboratory model system, is based on the commonly used liquid Diglycidyl Ether of Bisphenol A (DGEBA, Araldite MY 750, Vantico Ltd.). The curing agent used was a liquid aliphatic polyamine, polyoxypropylene diamine, with the commercial name of Aradur HY 5922 (figure 1). It was used at the stoichiometric weight ratio of 55 parts per 100 parts of epoxy resin. The

control sample was produced by mixing these components at room temperature for 15 minutes, then subdivided into several plastic containers and stored at -18°C for further use.

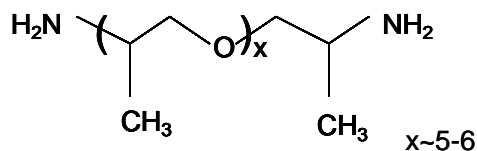

Figure 1: Chemical structure of Aradur HY 5922 curing agent

A commercial CNT-epoxy premix (Hyperion Catalysis Int. Inc.- CP1204) was used for the preparation of the corresponding nanocomposites. The premix contains 3.06 wt % of multi-walled carbon nanotubes pre-dispersed in a mixture of two difunctional epoxy resins with differing monomer molecular weights, namely EPON 828 and Epon 1009 F, in weight ratio of 4.6 / 1. To make the nanocomposite master batch, the epoxy monomer liquid was first pre-heated to about 70°C in order to reduce its viscosity. A carefully weighed out amount of the Hyperion pre-mix was added to the warm resin and mixed in using a DISPERMAT[®] CN F2 high shear mixer, at room temperature, for 40 minutes at 5000 rpm. The amine hardener (HY 5922) was then added to achieve the required 55/100 weight ratio, as in the control system. The mixing process continued for another 10 minutes. The final masterbatch had CNT content of 0.06 wt% and its samples were stored in individual plastic containers at -18°C for further processing. The cryo-fracture surface of a cured sample shown in figure 2 shows separated nanotubes, which would suggest that a reasonable dispersion of the nanotubes had been achieved in the masterbatches and persists through the cure. Nevertheless, it is clear that clusters of nanotubes must also be expected to be present in the final nanocomposites.

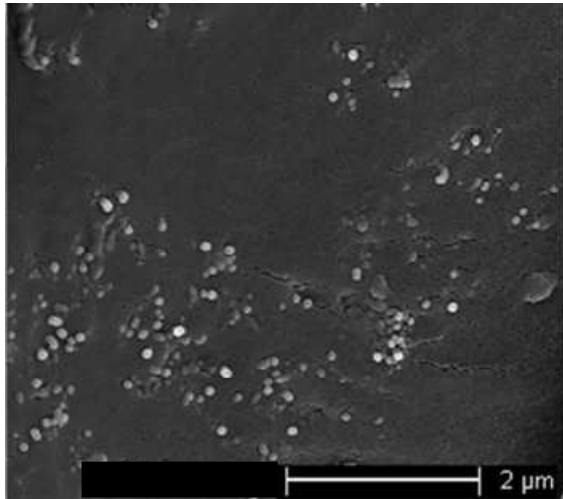

Figure 2: SEM image of the cold fracture surface of MY 750/HY 5922 resin system containing 0.06 wt % Hyperion carbon nanotubes after curing at 120°C for 2 hours

The second epoxy system used was a commercial formulated aerospace grade resin, MTM 44-1, product of Advanced Composites Group (ACG). It is described as a dual cure temperature and high performance epoxy matrix. The primary components are stated to be a tetrafunctional epoxy, two aromatic polyamines as curing agents and a toughening additive. The multi-walled carbon nanotubes used to produce a nanocomposites master batch in this case were supplied by Thomas Swan Co., UK (Elicarb Product reference SP7269, Batch reference K1005). The dry CNTs were dispersed in ethanol, in a sealed plastic container and subjected to ultrasonication in an Elmasonic S30H ultrasonic bath at 60°C for 60 minutes. After the ultrasonication treatment the container was opened and placed in an oven at 80°C for 20 minutes to evaporate the solvent, resulting in the production of a CNT 'cake'. The resin was heated on a hot plate to 80°C, held for 10 minutes in order to arrive at the minimum viscosity. At this temperature no significant curing reaction is expected to occur in this resin. Accurately weighed out portions of the CNT 'cake' were added and mixed in with a spatula, at 80°C, for a further 15 minutes. Given the high viscosity of this resin, even at its minimum viscosity level, it was not practical to use an electric stirrer. One masterbatch was prepared, containing 1 wt % of carbon nanotubes. It was sealed in a

plastic container and immediately placed in freezer at -18°C . The high viscosity of the mix, and the low temperature would limit any re-aggregation or settling of the nanotubes. The defrost procedure was always carried out with the container closed until it came up to room temperature, in order to avoid condensation of water, and a manual remixing of the content before any further sampling.

Thermal analysis

A TA Instruments 2920 TMDSC was utilised for the determination of the degree of cure achieved after a given time of cure, in selected isothermal cure experiments. The sample was first heated up to the desired temperature at heating rate of $20^{\circ}\text{C}/\text{min}$, the heating ramp typically lasting about 1 minute, and left to cure at the selected temperature. A simple horizontal baseline was used for the determination of the total heats of reactions [12,13].

A Bohlin CVO 120 HR high resolution fluid-to-solid rheometer was utilised for viscosity measurements in oscillating parallel plate configuration at a frequency of 1 Hz. After preheating the plates to the desired temperature of the isothermal experiment, the sample was put on the lower plate and the upper plate was lowered to make contact with the resin. The experiment was started after allowing the system to come to thermal equilibrium, typically for 2-3 minutes. Previous DSC experiments indicate that no significant reaction would have occurred in the resins in that time. The time between the onset of the rapid increase in viscosity and the cure time at which the dynamic viscosity exceeded 10 kPas was taken as the 'gelation period' [14].

Optical instrumentation and analysis

The configuration of the instrumentation used to measure the refractive index change during the curing reactions of the resins is shown in figure 3.

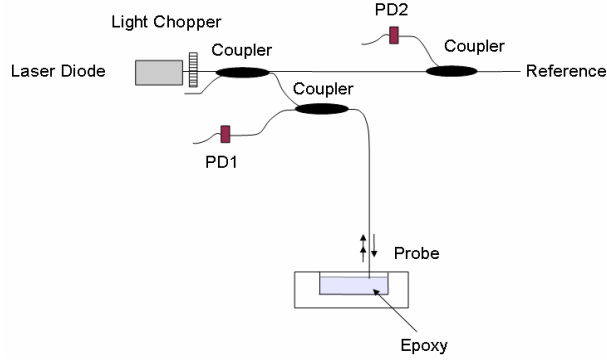

Figure 3: Experimental configuration used for the measurement of the refractive index change during cure

The output from the laser diode operating at the appropriate wavelength was intensity modulated and coupled into a network of directional couplers. The Fresnel reflection from the fibre / resin system interface was monitored using photodiode PD1. In the second arm, photodiode PD2 monitored the reflection from the air / optical fibre interface, acting as an intensity reference to aid the normalisation of the signal and to account for any change in power coupled into the optical fibre from the laser diode. The outputs from the photodiodes were monitored using lock-in amplifiers. The refractive index determined using the refractometer is given by the following equations [6]:

$$n = n_{effco} \frac{1 - \frac{\Delta}{\sqrt{R}}}{1 + \frac{\Delta}{\sqrt{R}}} \quad (1)$$

$$\Delta = \frac{n_{effco} - n_a}{n_{effco} + n_a} \quad (2)$$

$$R = \frac{V_{air}}{V_{epoxy}} \quad (3)$$

where, n_{effco} is the effective refractive index of the fibre mode, n_a is the refractive index of air given as 1.0002739 , V_{air} is the voltage produced by photodiode PD₂, obtained for the reflection from the fibre/air interface and V_{epoxy} is the voltage produced by photodiode PD₁, corresponding to the reflection from the fibre/resin interface.

For the correlation between the refractive index (RI) and the state of cure of the resin systems used, Cusano et al [3] reported on an equation that relates these two factors:

$$a_n = \frac{n_t - n_o}{n_\infty - n_o} \quad (4)$$

where n_t = RI at time t after the start of cure, n_o = RI at the beginning of cure and n_∞ = RI at the end of the cure. Equation 4 assumes a linear relationship between the degree of cure and the RI during the entire course of the cure. Equation 5 then relates the RI measurements to the real conversion values determined by the DSC experiments :

$$\alpha(T) = a_n \alpha_{DSC}^{\max}(T) \quad (5)$$

where $\alpha(T)$ is the fractional conversion at time t for isothermal cure at temperature T and $\alpha_{DSC}^{\max}(T)$ is the maximum conversion attainable at temperature T.

Results and Discussion

The simpler of the two resin systems, the MY750/HY 5922, was cured at 80°C for 6 hours. Figure 4 illustrates the evolution of the degree of cure for the resin system and its nanocomposite containing 0.06 wt % of the Hyperion carbon nanotubes. In both cases, the evolution of the absolute refractive index value, with cure time, is seen to parallel closely the progress of the chemical reaction, as indicated by the degree of cure determined from the DSC measurements. The refractive index data for the CNT-containing system (figure 4b) exhibit rather more scatter than the equivalent data for the neat resin.

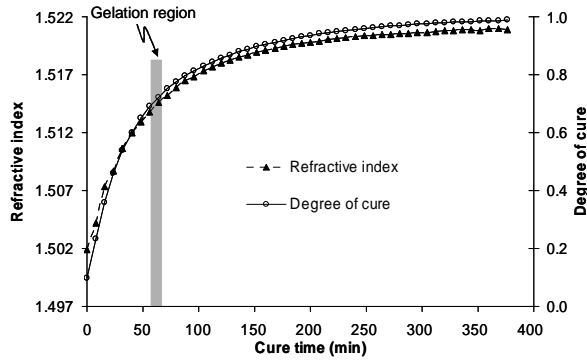

(a)

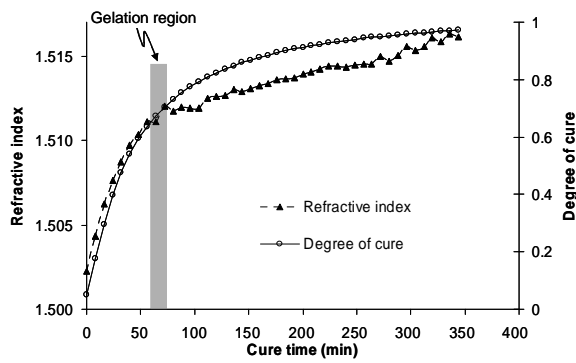

(b)

Figure 4: Refractive index and degree of cure (based on the isothermal cure experiments) comparison for a) the isothermal cure of the MY 750 / HY 5922 system and b) for the MY 750 / HY 5922 system containing 0.06 wt % of Hyperion carbon nanotubes at 80°C for 6 hours (1550 nm)

The correlation coefficient between the two entities is 0.9977 for the neat resin (figure 5) and 0.974 for the nanocomposite. The absolute values of the refractive index start at 1.5019, corresponding to the uncured neat resin and go up to 1.5201 for the fully cured resin, while for the nanocomposite the values are 1.5025 and 1.515 respectively.

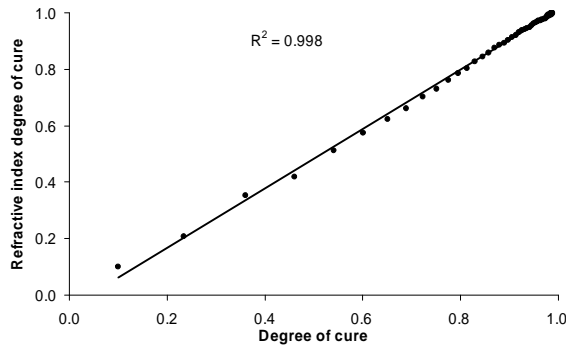

Figure 5: Correlation between the degree of cure and the degree of cure established from the refractive index measurements for the isothermal cure of the MY 750 / HY 5922 at 80°C for 6 hours (1550 nm)

The position and extent of the gelation region, in terms of cure time, is estimated from independent rheological measurements, carried out under the same cure conditions. In figure 6, the onset of the rapid increase of dynamic viscosity is taken to indicate the onset of gelation.

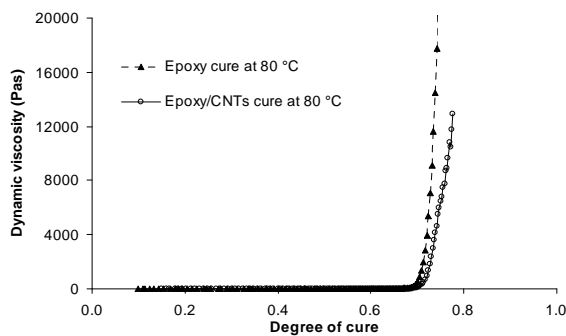
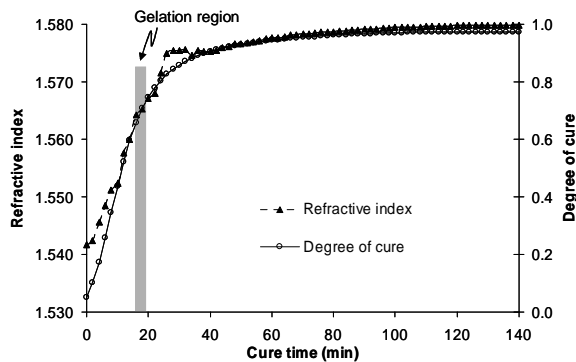

Figure 6: Dynamic viscosity advancement versus degree of cure for the isothermal cure of the MY 750 / HY 5922 resin system and its nanocomposite containing 0.06 wt % Hyperion carbon nanotubes at 80°C

The absolute value of conversion at which the system appears to gel is rather higher than would be expected theoretically in this system [15]. This could be a real effect, given the flexible molecular structure of the hardener, or it could be an artefact of the measurement method, dynamic viscosity being just one particular manifestation of molecular mobility within the crosslinking network.

An independent determination of gelation was attempted, by dielectric measurements [11, 16] but was not successful in this system. Isothermal cures were carried out at 180°C for 2 hours for the MTM 44-1 resin system and its nanocomposite containing 1 wt % of Thomas Swan carbon nanotubes. The embedding of the optical fibre sensor was rather more difficult in this resin, because of the high initial viscosity of this blended system. The resin was first heated up to 80°C (for 5-10 minutes) to achieve minimum viscosity, allowing the penetration of the fibre without damage, but not setting off the cure reaction. The sample was then allowed to cool down to room temperature before the cure experiment was started. The results are shown in figure 7.



(a)

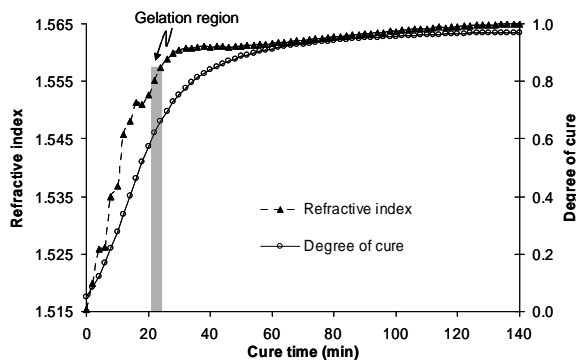

(b)

Figure 7: Refractive index and degree of cure (based on the isothermal cure experiments) comparison for the isothermal cure of a) the MTM 44-1 system and b) the MTM 44-1 resin system containing 1 wt % of Thomas Swan carbon nanotubes at 180°C for 2 hours (1550 nm)

Gelation in the neat resin was determined by viscometry and the same level of conversion was assumed to lead to gelation in the nanocomposite. The fact that gelation occurs later in the nanocomposite is a result of the slowing down of the chemical reaction through the presence of the nanotubes [17]. Both neat resin and nanotube modified samples give rise to a noisy signal from the start of the reaction up to gelation. The refractive index of the uncured neat epoxy system was 1.5420 rising to 1.5798 at the end of the curing reaction. For the nanocomposite the values are 1.5153, and 1.5650 respectively. There are numerous possible reasons for the noisy signal obtained from the optical sensor. The first of these could be the movement of tiny air-bubbles, which would be expected to be inhibited by gelation. Furthermore, in this blended resin system, phase separation leads to a highly heterogeneous two-phase structure. SEM images of cryo-fractures of neat resin, presented in figure 8a, show thermoset particles with a size range 3 - 13 μm , embedded in a continuous matrix which is believed to be thermoplastic-rich. The incorporation of carbon nanotubes appears to result in an average increase in the particle size, now 5 - 50 μm , with the majority of the particles having a mean diameter of 8-10 μm (see figure 8 b).

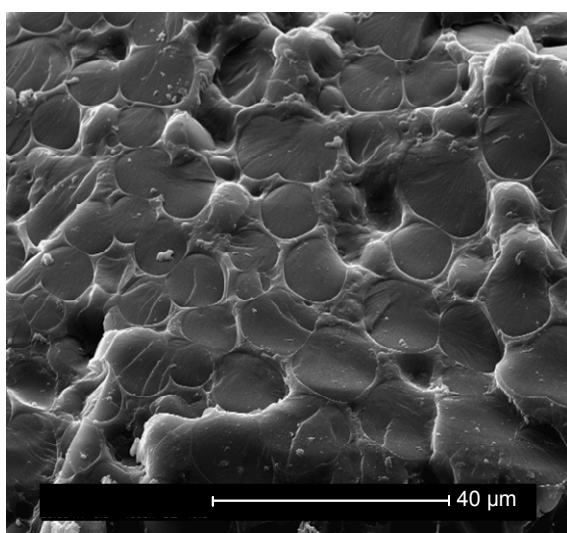

(a)

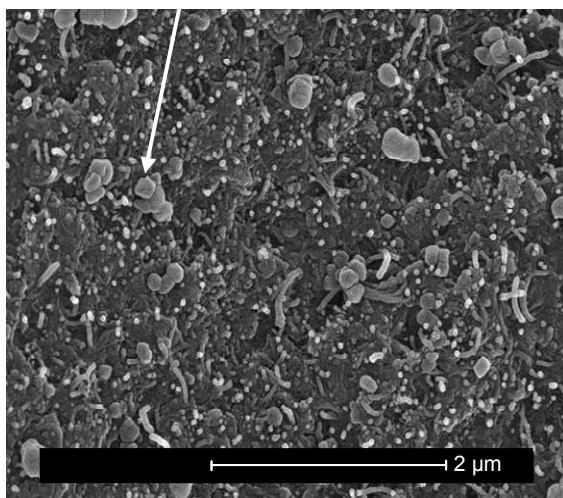
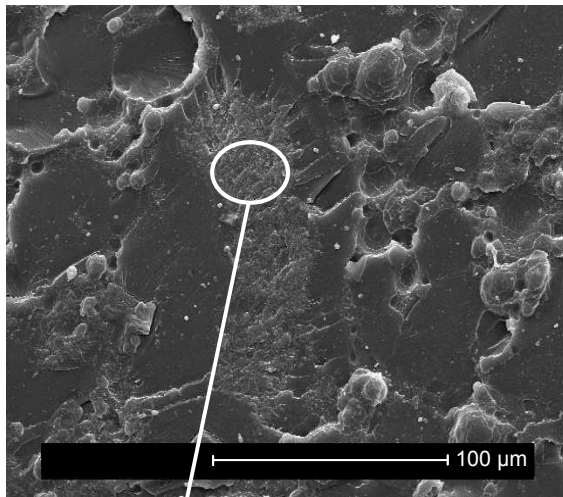

(b)

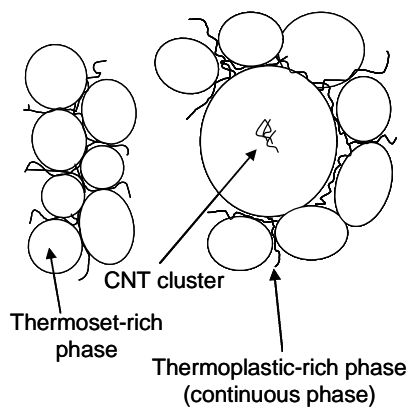

(c)

Figure 8: MTM 44-1 resin system a) without the incorporation and b) with the incorporation of 1 wt % Thomas Swan carbon nanotubes after curing at 190°C for 2 hours. c) Schematic representation of the system with and without the incorporation of carbon nanotubes.

A diagrammatic representation of the particles in relation to the optical fibre is shown in figure 9. It is not clear how far the 'sensing volume' from the optical fibre core extends, but any movement of CNTs, CNT clusters, or indeed formation of particulate structures within this volume would be expected to result in some fluctuation in the signal.

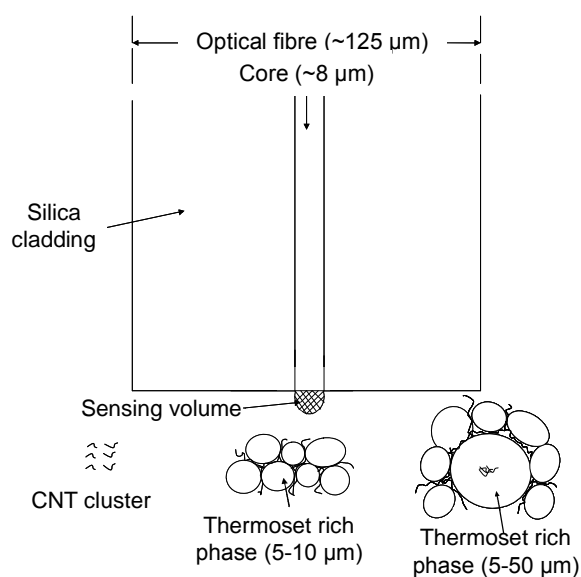

Figure 9: Schematic of the optical fibre embedded into the MTM 44-1 resin system and its nanocomposite containing 1 wt % Thomas Swan carbon nanotubes

Conclusions

This early study has indicated that cure monitoring via a fibre optic Fresnel refractometer is a viable proposition for nanotube filled thermosets. The data show the need for improvement in the signal-to-noise ratio, however, this may not be possible if the sources of the noise are intrinsic to the behaviour of the resin system. In terms of the desirable optical properties of the fibre itself, for the particular resins tested here, the refractive index range should be between 1.5 and 1.6.

Acknowledgements

The work reported here was funded in part by EPSRC 'Speculative Research in Engineering' Grant EP/C509730 and in part by Cranfield University IMRC. The authors acknowledge gifts of raw materials by Advanced Composites Group and Thomas Swan & Co. Ltd.

References

1. Lam K-Y, Afromowitz MA, *Applied Optics*, 1995; 34: 5635-5638
2. Lam K-Y, Afromowitz MA, *Applied Optics*, 1995; 34: 5639-5644
3. Cusano A, Breglio G, Giordano M, Calabro A, Cutolo A, Nicolais L, *Sensors and Actuators*, 2000; 84: 270-275
4. Kim CB, Su CB, *Measurement Science and Technology*, 2004; 15: 1683-1686
5. Degamber B, Fernando GF, *MRS Bulletin*, 2002; 27: 370-380
6. Buggy SJ, Chehura E, James SW, Tatam RP, *Journal of Optics. A: Pure Applied Optics*, 2007; 9, S60-S65
7. Paradise M, Goswami T, *Materials and Design*, 2007; 28:1477-1489
8. Baugham R, Zakhidov A, Heer W, *Science*, 2002; 297: 787-792
9. Baur J, Silverman E, *MRS Bulletin*, 2007; 32:328-334
10. Winey KI, Kashiwagi T, Mu M, *MRS Bulletin*, 2007; 32: 348-353
11. Partridge IK, Maistros GM, 'Dielectric Cure Monitoring for Process Control', Chap. 5.17 in 'Comprehensive Composite Materials', eds. Zweben K and Kelly A, Elsevier, 2000
12. Skordos AA, Partridge IK, *Inverse Problems in Science and Engineering*, 2004; 12: 157-172
13. Karkanas PI, Partridge IK, *Journal of Applied Polymer Science*, 2000; 77: 1419-1431
14. Karkanas PI, Partridge IK, *Journal of Applied Polymer Science*, 2000; 77; 2178-2188

15. Flory PJ, 'Principles in Polymer Chemistry', Cornell University Press, Ithaca, New York, 1953
16. Skordos AA, Partridge IK, Journal of Polymer Science: Part B: Polymer Physics, 2004; 42: 146-154
17. Dimopoulos A, Skordos AA, Partridge IK, 'Cure of a carbon nanotube modified multiphase epoxy-thermoplastic resin system '49th AIAA/ASME/ASCE/AHS/ASC Structures, Structural Dynamics, and Materials Conference, AIAA-2008-2119

Monitoring cure in epoxies containing carbon nanotubes with an optical-fiber fresnel refractometer

Dimopoulos, A.

2009-07-15T00:00:00Z

Athanasios Dimopoulos, Stephen J. Buggy, Alexandros A. Skordos, et al., Monitoring cure in epoxies containing carbon nanotubes with an optical-fiber fresnel refractometer. *Journal of Applied Polymer Science*, Volume113, Issue 2, 15 July 2009, Pages 730-735

<http://dx.doi.org/10.1002/app.30115>

Downloaded from CERES Research Repository, Cranfield University