The development of knowledge-shelf to enable an effective set-based concurrent engineering application

Supriana Suwanda* and Ahmed Al-Ashaab

School of Aerospace, Transport and Manufacturing,
Cranfield University,
Building 50, Cranfield, Bedfordshire MK43 0AL, UK
Email: supriana.suwanda@bppt.go.id
Email: a.al-ashaab@cranfield.ac.uk
*Corresponding author

Najam Beg

Caltec Production Solutions Ltd.,
1 South House, Bond Avenue, Milton Keynes MK1 1SW, UK
Email: najam.beg@caltecps.com

Abstract: This paper presents the development of knowledge-shelf (K-shelf) concept to enable set-based concurrent engineering (SBCE) application via knowledge provision. Three main outcomes are presented: 1) concept of the K-shelf in supporting designers throughout SBCE process; 2) demonstrates the concept via web-based software; 3) an industrial case study of surface jet pump (SJP) is also presented to validate the K-shelf concept and its software demonstrator. The K-shelf capabilities of capturing and storing design rationale in a well-structured manner and to support the comparisons among set of design solutions are the main focus of this paper.

Keywords: set-based concurrent engineering; SBCE; knowledge provision; knowledge-shelf; design rationale; trade-off curve; TOC; surface jet pump; SJP.

Reference to this paper should be made as follows: Suwanda, S., Al-Ashaab, A. and Beg, N. (2020) 'The development of knowledge-shelf to enable an effective set-based concurrent engineering application', *Int. J. Internet Manufacturing and Services*, Vol. 7, No. 4, pp.407–427.

Biographical notes: Supriana Suwanda is an Engineer at the Laboratory for Information and Communication Technology (BJIK) – a subsidiary of the Agency for Assessment and Application of Technology (BPPT), Indonesia. He has 12-year technical background in knowledge management system development. In 2015, he was awarded Research and Innovation in Science and Technology Project (RISET-Pro) scholarship by the Ministry of Research and Technology, Indonesia. He earned his PhD in Manufacturing at Cranfield University (UK), Master's degree from Bogor Agricultural University (Indonesia) and Bachelor at Bina Nusantara University (Indonesia) both in Computer Science. His current research interest is in data science.

Ahmed Al-Ashaab is a reader in lean product development, Leader of the Lean PPD Research Group and Course Director of the MSc in Global Product Development and Management at the Manufacturing Department of Cranfield University. He was the Technical Coordinator of the LeanPPD European Project and set-based design expert in the TSB-CONGA project. His research career started after he obtained PhD from Loughborough University in 1994. He then worked at ITESM Campus Monterrey in Mexico from 1994 to 2000. He has 26 years of teaching experience in Mexico, Colombia, France and the UK. He has 100 research papers and supervised 150 theses.

Najam Beg is the Co-Founder of Caltec Production Solutions Ltd. UK. He is a world-class expert in surface jet pump technologies for oil and gas production boosting. He is acting as an Industry Supervisor to students in the UK and Norway universities. He earned his PhD at Imperial College (UK), MS from WVU (USA) and BSc at UET (Pakistan) all in Petroleum Engineering. He has won several awards: Gold Medal from The Royal Society and a World Oil Award, USA for a world's first largest supersonic gas production boosting system. He holds several patents with 50 publications.

1 Introduction

Manufacturing companies seek to increase the effectiveness and efficiency of their product development (PD). Lean PD which is resting upon Toyota's PD system is an assuring approach to overcome these challenges. It is validating to such an extent that Toyota is consistently developing higher quality vehicles faster, cheaper and at a more return than their competitors (Liker and Morgan, 2006). Ward et al. (1995) argued Toyota conducts set-based concurrent engineering (SBCE), where sets of design alternative are explored in parallel and gradually narrowed down until the optimal design is achieved. SBCE has been emergently understood as the core element of lean PD (Khan et al., 2011). A knowledge environment is one of the important requirements for a successful SBCE application (Araci et al., 2016). Knowledge environment in this paper refers to a scheme of practices and technologies of knowledge provision to support designers throughout SBCE application. There are various knowledge sources in SBCE, e.g., design standard, design rule, trade-off curves (TOCs) and previous projects (Khan et al., 2013; Maksimovic et al., 2012). The authors believe that design rationale is another source of knowledge in SBCE application. This is to record the reasons of design sets feasibility by articulating the logical relationship between the subsystems and their properties. This paper proposes the knowledge-shelf (K-shelf) as a knowledge environment to capture design rationale throughout SBCE process.

This paper is presenting the concept of the K-shelf to enable SBCE application and demonstrates the concept via web-based software. The work is validated using an industrial case study of surface jet pump (SJP). The K-shelf capabilities of capturing and storing design rationale in a well-structured manner and to support the comparisons among set of design solutions is the main focus of this paper.

The research approach adopted to carry out the work presented in this paper is the design science research. The design science approach seeks to consolidate knowledge about the design and development of solutions, to improve existing systems, solve problems and create new solutions (Dresch et al., 2015). The paper is structured as

follows: Section 1 presents the introduction, Section 2 is a review of the related literature, Section 3 discusses the concept of K-shelf, Section 4 presents the demonstrator of K-shelf and Section 5 concludes the paper.

2 A review of the related literature

This section describes the theoretical and practical framework regarding which concepts, models, methods, or instantiations were used for solving the issues of knowledge provision in SBCE applications. Knowledge provision is the process of providing the right knowledge to the engineering activities in the right format and time. This research is concerned about the PD knowledge to enable the application of SBCE. Design rationale implementations have been presented in various PD approaches but methods for recording the reasons of design sets feasibility by articulating the logical relationship between the subsystems and their properties as another source of knowledge in SBCE application are not available.

2.1 SBCE overview

Ward et al. (1995) discovered that the real success of Japanese manufacturers originated from the Toyota PD System rather than their production system. Ward found this through investigating multiple alternative solutions during the styling activity rather than deciding to pursue one solution. Design participants practice SBCE by reasoning, developing, and communicating about a set of solutions in parallel. As the design progresses, they gradually narrow down their respective set of solutions based on the knowledge gained. As they narrow, they commit to staying within the sets so that the others can rely on their communication (Sobek et al., 1999). A SBCE approach allows to handling of various sources of uncertainties during early stages of PD and helps make well founded decisions which significantly reduces the need for iteration process (Kennedy et al., 2014; Ward and Sobek, 2014).

Figure 1 The SBCE process model (see online version for colours)

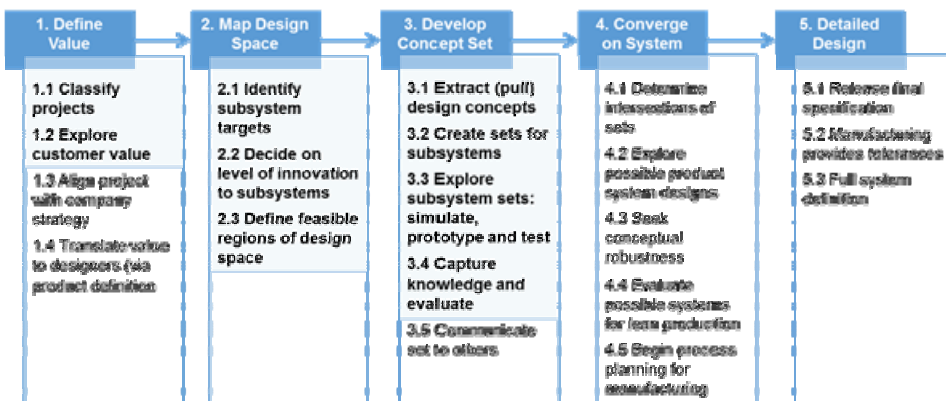

Source: Khan et al. (2011), Al-Ashaab et al. (2013)

The principle of SBCE was described in the conceptual framework which breaks into three broad principles; map the design space; integrate by intersection; and establish feasibility before commitment (Sobek et al., 1999). However, they have not provided a detailed SBCE process model. Khan et al. (2011) and Al-Ashaab et al. (2013) have managed to design a well-structured SBCE process model which consists of five stages: define value, map design space, develop concept sets, converge on system, and detailed design as shown in Figure 1. Several case studies have been performed using their SBCE process model around aerospace, oil and gas, and automotive industries. A case study to identify the potential benefit of SBCE application has been done recently (Maulana et al., 2017), however it is limited as a paper-based application which has not been advanced into a comprehensible format to support designers to innovate or improve a product in a knowledge environment.

2.2 Knowledge environment in SBCE

Knowledge environment is an environment that applies a positive influence on human beings encouraging production of new knowledge or innovations (Hemlin et al., 2008). Van den Bosch et al. (1999) distinguished the type of knowledge in knowledge environments of companies into knowledge that related to products, processes and markets. Sobek et al. (1999) highlighted the importance of organisational knowledge in forming the exceptional Toyota PD. The provision of a knowledge environment is advised as the key enabler for the lean PD (Al-Ashaab and Sobek, 2013). Maksimovic (2013) proposed a knowledge life cycle framework to assist in the creation of knowledge environments to support lean PD. The SBCE, on other hand, is the core process of any lean PD (Aikhuele and Oluwadare, 2019; Ward et al., 2007). Khan et al. (2013) use the terminology of knowledge-based environment to address design alternatives in PD activities. Reuse of design knowledge from previous design activities could improve engineering design (Baxter et al., 2008). Documentation of product knowledge in companies stresses the representation of the design, rather than the process of creating it (Ramesh and Sengupta, 1995). In such documentation, a developed design is usually defined in terms of parameters and specifications to describe the way the design works. The documentation, however, does not include the design rationale that explains why the conceptual design is designed in the way it is (Regli et al., 2000). Design rationale provides an insight into the reasons and justifications behind the design decisions (Lee, 1997) which can be used to determine what part of the design can be reused or modified. A proper knowledge environment to enable SBCE is yet to be realised. Reported research is proposing the K-shelf as a suitable knowledge environment to SBCE application.

Knowledge provision has been identified as one of the industrial challenges in managing PD, particularly in the issue of timely provision of accurate knowledge at the right place. Maksimovic et al. (2014) pointed out that there are four knowledge provision challenges: form, innovation, time and place. Knowledge provision should facilitate designers to have a greater variety of exposure to alternative design concepts (Zhu et al., 2011) and one method to provide it is the TOC (Araci et al., 2016). A suitable knowledge environment is important to have effective application of SBCE. The literature attempted to address knowledge provision through one of the following; database (Al-Ashaab et al., 2014; Essamlali et al., 2017; Wang and Terpenney, 2003; Wasim et al., 2013), knowledge base (Jeang and Liang, 2012; Malak et al., 2009), and case-based reasoning (CBR). A limited amount of research has been conducted on software system development by

which to facilitate the application of SBCE. Recent research on software systems to support SBCE practice is addressing communicating set of design (Correia et al., 2014; Gray and Singer, 2015) and embedding SBCE into PLM software (Essamlali et al., 2017). Knowledge database is exemplified in Toyota PD; however, it is not explained in detail. “The knowledge database contained in charts and tables forms a kind of map of the solution space which can be consulted in future projects by both supplier and customer” (Liker et al., 1996). In contrary to Gray and Singer (2015) who proposed a fuzzy approach in negotiating the propagation of conceptual design in SBCE, (Canbaz et al., 2014) argued that it is not preferred since it generates longer process time and more conflict among designers. The reviewed literature clearly highlights the importance of knowledge provision in SBCE application. Although the literatures discuss different types of knowledge, there is a lack of practical software solution that provides the right knowledge environment to enable an effective SBCE application.

3 Concept of the K-shelf

The K-shelf is a concept being developed in this research to provide a knowledge environment for designers in an SBCE environment as presented in Figure 2. The K-shelf is designed to capture, compare and reuse knowledge from sets of conceptual designs throughout SBCE processes represented in Figure 1. The K-shelf is commenced with the generation of the first conceptual design set as shown in Figure 2(a). The first conceptual design set are as follows:

- 1 the yellow triangle represents a design that was pulled from previous projects
- 2 the blue square represents a design that was pulled from research and development projects
- 3 the green circle represents a design that was a new conceptual design generated during the project under consideration.

In SBCE, as the design progressed, the set is gradually narrowed based on the knowledge gained due to simulation, prototyping, testing and other engineering evaluations. Therefore, infeasible design solutions which are represented in red will be removed from the set, whilst the feasible design solutions are carried on as indicated in Figure 2(b). However, these infeasible conceptual designs are saved back to the K-shelf along with their design rationale as shown in Figure 2(b). The reason behind this, is although solutions are not good for the current project, they might be useful for other or future projects. Figure 2(c) shows the second narrowed down set of conceptual designs as a result of the application of SBCE. As the design progresses, the set is gradually narrowed based on the knowledge gained and again the designs and rationale of weak or infeasible solutions are also captured as shown in Figure 2(d) until the final optimised design solution is obtained as shown in Figure 2(e).

The K-shelf is intended to have the following capabilities:

- 1 dynamic knowledge capture by capturing rationale of design decisions throughout the application of SBCE
- 2 store the captured knowledge in well-structured manner

- 3 support the generation of a set of design
- 4 support the comparison among set of solutions
- 5 knowledge re-use within the same project
- 6 knowledge re-use for another project.

In this paper capabilities numbers 1, 2 and 4 are considered.

Figure 2 The K-shelf concept (see online version for colours)

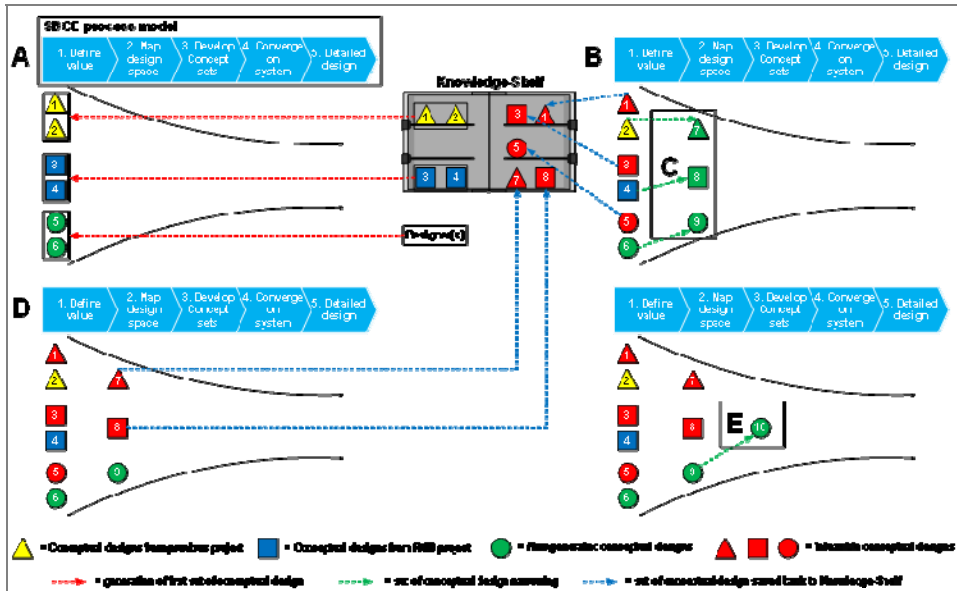

4 The demonstrator of the K-shelf software

4.1 The SJP case study

The aim of the case study is to justify the concept of the K-shelf in capturing and storing design rationale in a well-structured manner and to support the comparisons among sets of the SJP design solutions throughout selected SBCE process models. The SBCE process model was implemented during the case study of SJP in collaboration with a company from oil and gas industry.

The SJP is a device used to increase production rate and to revive dead wells in the oil and gas industry. The general function of the SJP is to boost the pressure of low pressure (LP) fluids, which is needed at different stages of the production process. Compared to traditional methods of increasing pressure with the use of compressors, the SJP are highly cost-effective solutions that provide the same performance. The SJP utilises kinetic energy from a high pressure (HP) source to increase the pressure of the LP fluid as shown in Figure 3(a). The key components of the SJP are listed and shown in Figure 3(b) which are comprised of flanges for manifold attachment; a nozzle for the motive HP fluid; a mixing tube for transfer of energy and momentum between HP and LP

fluid streams; and a body to integrate the components and provide suitable flow direction of the fluid.

Figure 3 Key components of SJP (see online version for colours)

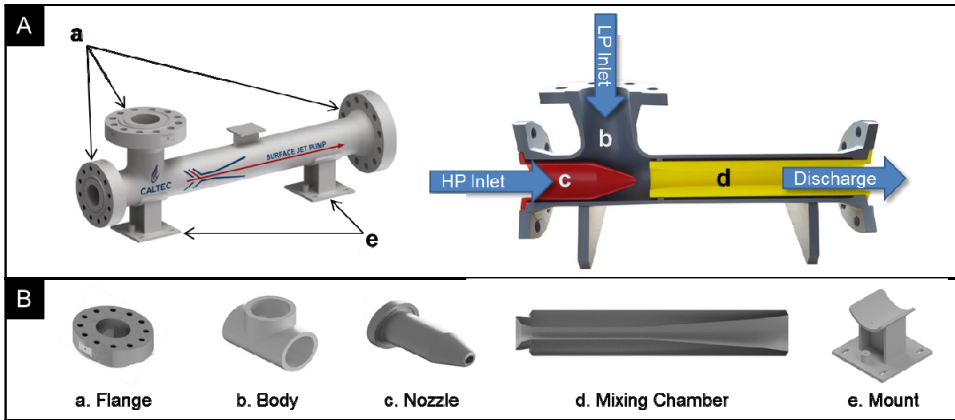

4.2. The K-shelf software architecture

The K-shelf is developed using Oracle Application Express (APEX) and object-oriented procedural language/structured query language (PL/SQL) programming. The architecture of the K-shelf is structured into two tiers – client application and database as shown in Figure 4. The K-shelf can host numbers of SBCE projects. The end user of the K-shelf could be assigned as a designer of one SBCE project or several SBCE projects at a time. For example, in Figure 4, D1 is a designer in SBCE1 project. D2 is a designer involved in SBCE2 and SBCE3 projects. Both of D2 and D3 are designers involved in the same SBCE3 project. Designers could access K-shelf from web browsers installed on laptops, desktop PCs or tablets through a web server which is located inside the embedded PL/SQL gateway (EPG). Each SBCE project webpage in K-shelf is triggered by URL requests sent from a designer’s web browser and rendered using metadata stored within the Oracle database. The K-shelf utilises database schema as its logical container for data structures, called schema objects. This schema object represents the data structures of conceptual designs during the SBCE project under consideration. For example, Schema1 is associated to project SBCE1 and Schema2 and Schema3 are respectively associated to project SBCE2 and SBCE3 as shown in Figure 4.

The case study of SJP shown in Figure 3 has got several components; one of them is the nozzle. Figure 5 illustrates partial class representation of SBCE process and associated class of SJP which is managed in K-shelf. In this paper, class in K-shelf represents the conceptual designs of the product’s systems and subsystems/components which will be demonstrated in Sections 4.4.2 and 4.4.3. In Figure 5, two instances of inheritance are established between *SYSTEM* class and *SURFACE_JET_PUMP* class, also between *SUBSYSTEM* class and *NOZZLE* class. The *SURFACE_JET_PUMP* and *NOZZLE* is child of *SYSTEM* and *SUBSYSTEM* classes, respectively. A child-class inherits the characteristics of the parent-class. Inheritance facilitates reusability and is an

important concept of object-oriented approach. With inheritance, the development of the K-shelf software can reuse the attributes and methods of the existing class.

Figure 4 System architecture of K-shelf (see online version for colours)

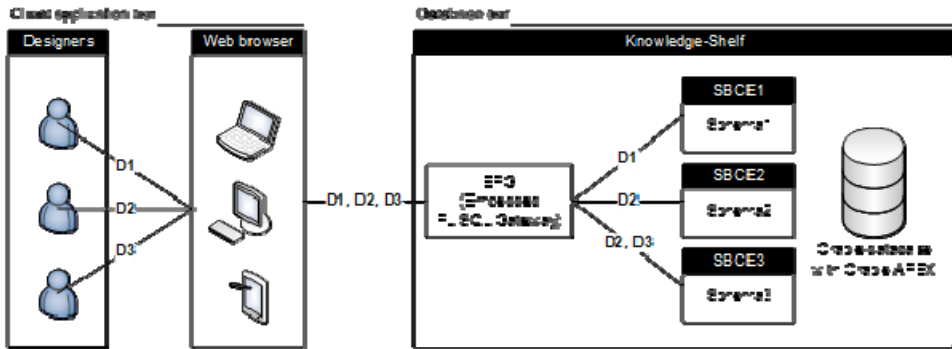

The PROJECT class as shown in Figure 5 represents Activity 1.1 to classify project in SBCE process model (refer to Figure 1). The PROJECT class has six attributes: *project_id*, *project_objective*, *project_start*, *project_finish*, *project_cost*, *project_market* and has one method: *updateProject()*. The PROJECT class has one-to-one multiplicity relationship with SYSTEM class. This means that each SBCE project has one and only one product at system level, and a system belongs to one and only one project. The SYSTEM class is associated with Activity 1.2 in SBCE process model to explore customer value. The SYSTEM class has two attributes: *system_id* and *system_name* and has one method: *updateSystem()* to return the updated value to *system_name* attribute.

Figure 5 Class diagram of SBCE process associated with SJP (see online version for colours)

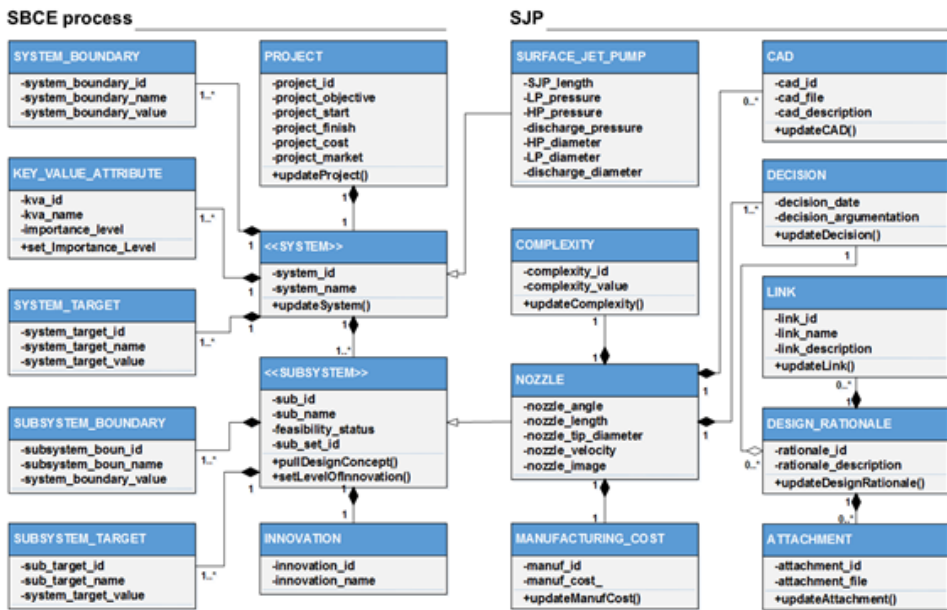

The *SYSTEM* class is composed of *SYSTEM_BOUNDARY*, *SYSTEM_TARGET* and *KEY_VALUE_ATTRIBUTES* classes which capture system boundaries, system targets and key value attributes (KVA) of the system respectively. The *SYSTEM_BOUNDARY* class consists of three attributes: *system_boundary_id*, *system_boundary_name* and *system_boundary_value* which can be used later to define the design space as mentioned in Activity 2.3 of SBCE process model to define feasible regions of design space. The KVA are values that have been classified as high importance and each of them is measured by load of importance in percentage. The *KEY_VALUE_ATTRIBUTES* class has two attributes: *kva_id* and *kva_name*, and two methods: *updateKva()* and *updateImportanceLevel()*.

The *SYSTEM_TARGET* class has three attributes: *system_target_id*, *system_target_name* and *system_target_value* as shown in Figure 5. The system targets are specified to explain how the value attributes will be reached. The *SYSTEM* class is parent for *SURFACE_JET_PUMP* class which then inherit all the attributes and methods. The *SURFACE_JET_PUMP* class owns their specific attributes: *SJP_length*, *LP_pressure*, *HP_pressure*, *discharge_pressure*, *HP_diameter*, *LP_diameter* and *discharge_diameter*, and does not have any method.

A system can have at least one subsystem/component. The *SUBSYSTEM* class is composed of *SUBSYSTEM_BOUNDARY* and *SUBSYSTEM_TARGET* classes that act similarly to *SYSTEM_BOUNDARY* and *SYSTEM_TARGET* yet in subsystem level. The *SUBSYSTEM_TARGET* class represents Activity 2.1 in SBCE process model as shown in Figure 1 to identify subsystem targets. The *SUBSYSTEM* class has four subsystems: *sub_id*, *sub_name*, *feasibility_status* and *sub_set_id*. The first two attributes can retrieve returned value from *pullDesignConcept()* method in *SUBSYSTEM* class which is associated to Activity 3.1 in SBCE process model to extract/pull design concepts. The *pullDesignConcept()* method populates set of component designs from previous projects.

The new subsystems are generated outside the K-shelf software shelf using computer-aided drafting software which includes the process of creating a technical draw. The SolidWorks software was used in this thesis to draft tapered faces of various nozzles with desired angle. Subsequently; designers input them to K-shelf software as mentioned in Activity 3.2 of SBCE process model to create sets for subsystem. The other method in *SUBSYSTEM* class is *setLevelOfInnovation()* which has a mutual with *INNOVATION* class to define the subsystem's level of innovation that associated with Activity 2.2 of SBCE process to decide on level of innovation to subsystem. The *SUBSYSTEM* class is parent for *NOZZLE* class which then itself inherit all the attributes and methods. Apart from inherits the *SUBSYSTEM* class, the *NOZZLE* class has also specific attributes: *nozzle_angle*, *nozzle_lenght*, *nozzle_tip_diameter*, *nozzle_velocity* and *nozzle_image* and does not have any method.

The component's complexity and its manufacturing cost are also determined and recorded as presented in *COMPLEXITY* and *MANUFACTURING_COST* classes. As the design progresses, design decisions are made, the set is gradually narrowed based on the knowledge gained and the rationale of the weak or infeasible solutions are also captured as shown in the relationship between *DECISION* and *DESIGN_RATIONALE* classes. Apart of decision argumentation and design rationale description, *LINK* and *ATTACHMENT* classes are elaborated to provide further reference to the design decision rationale being made as shown in Figure 5.

4.3 The K-shelf graphical user interface

The K-shelf's graphical user interface (GUI) is designed in accordance with selected activities in SBCE process which are highlighted in bold as shown in Figure 1. The K-shelf software's GUI consists of:

- 1 regions: the area of a page that serves as a container for selected SBCE activities
- 2 a navigation bar: a bar on the left side that serves as a placeholder for SBCE phases.

The homepage of K-shelf is shown in Figure 6. The K-shelf software is invoked when the users navigate their internet browser to particular IP addresses of the web server which is located inside the embedded EPG as shown in Figure 6(a). This homepage has the title K-shelf in the navigation bar along the top and SBCE phases in the navigation menu along the left side of the page as shown in Figure 6(b). In the main window of K-shelf's homepage, the K-shelf concept and SJP case studies are presented in collapsible regions as shown in Figure 6(c).

Figure 6 K-shelf user interface (see online version for colours)

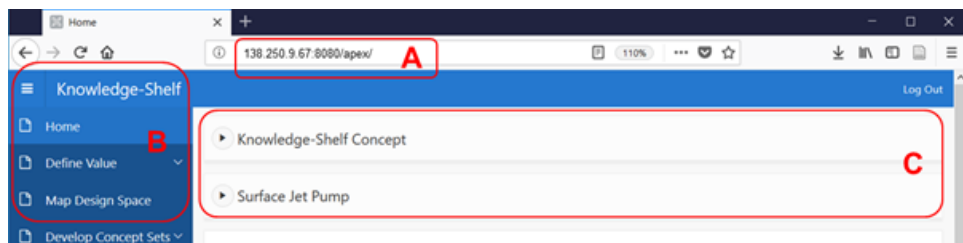

The main window content changes based on what SBCE phase the users are currently selected on. For example, when the define value menu in navigation bar is selected, the main window will show the explore customer value region and its two sub activities: KVA and system targets as shown in Figure 7. System targets of SJP, e.g., high pressure ≥ 400 psig, low pressure ≤ 205 psig and discharge pressure ≥ 320 psig are measurable values which represent the target for the KVA and will be explained further in Section 4.4.1.

4.4 Capturing design rationale of SJP in K-shelf

4.4.1 Define SJP customer value in K-shelf

Customer values must be clearly understood to identify SJP system targets, which focus on the improvement of the SJP design performance. During the SJP case study, 38 customer values are identified and then these values are organised into customer value classification – cost, customisation, design performance, manufacturability, reliability, durability, and installation. Worth noting, the customer value exploration activity is done outside K-shelf software by key personnel within the industrial collaborator, SJP designers and SBCE practitioners by way of paper exercise. The K-shelf software enables designers to transform the obtained paper-based customer values to be formally represented and classified in a database for future reuse. Manual input of customer values is also minimalised due to the availability of uploading feature in the K-shelf software

that allow the designer to upload customer values and their classification into the K-shelf in the form of comma separated value (CSV).

Figure 7 K-shelf demonstrates customer value exploration during the SBCE process (see online version for colours)

The screenshot shows the K-shelf software interface with several key components:

- Section A:** A red box highlights the 'Load Customer Value' button in the top right of the 'Explore Customer Value' panel.
- Section B:** A red box highlights the 'Data Load Source' dialog box, which includes options for 'Upload file, comma separated (*.csv) or tab delimited' and a 'Browse...' button for selecting a file.
- Section C:** A red box highlights the 'Explore Customer Value' table, which lists 10 customer values and their classifications.
- Section D:** A red box highlights the 'Key Value Attributes' table, which shows the classification of the customer values into various attributes like Value Classification, AHP Priority, and Company Prioritisation.
- Section E:** A red box highlights the 'System Targets' table, which lists system targets and their corresponding key value attributes.

No	Customer Value Name	Value Classification
1	Cheaper possible manufacturing cost	Cost
2	No additional energy consumption	Cost
3	Maintenance free	Cost
4	Zero operational cost	Cost
5	Fastest possible manufacturing	Manufacturability
6	Machining from very small to large scale	Manufacturability
7	Shorter in length	Manufacturability
8	Low complexity	Manufacturability
9	Alignment of the tube (nozzle to the mixing tube)	Manufacturability
10	Smooths surface inside the SIP (minimum friction)	Manufacturability

Value Classification	AHP Priority (%)	Company Prioritisation	Key Value Attribute	Load of Importance
Cost	13.85	3	<input checked="" type="checkbox"/>	18.6
Customisation	6.84	6	<input type="checkbox"/>	0
Design Performance	22.26	1	<input checked="" type="checkbox"/>	30.3
Durability	16.69	4	<input checked="" type="checkbox"/>	22.4
Installation	3.05	7	<input type="checkbox"/>	0
Manufacturability	21.64	2	<input checked="" type="checkbox"/>	29.07
Reliability	15.66	5	<input type="checkbox"/>	0

System Target Name	Key Value Attributes (KVA)
HP pressure >= 400 psig	Design Performance
LP pressure >= 205 psig	Design Performance
No moving parts	Design Performance
Strong material type	Durability
Ability to handle vibration	Durability
Low manufacturing cost	Cost
Maintenance free	Cost
Low complexity	Manufacturability
Fastest possible way to manufacture	Manufacturability
Easy to change and install	Design Performance

Activity 1.2 explore customer value in the SBCE process (refer to Figure 1) is the initial activity demonstrated in K-shelf software as shown in Figure 7. The designer begins the customer values upload by clicking load customer value button as shown in Figure 7(a). This will execute the data load wizard and enable the designer to upload a CSV file of customer values as shown in Figure 7(b). After successful data mapping and validation, customer values and their respective classification are recorded in the K-shelf. Figure 7(c) displays automated pagination of ten customer values from the totals of 38 customer values. Subsequently, the K-shelf automatically extracts customer value classifications into KVA region and lets the designer to input the weight of prioritisation for each customer value according to pairwise comparisons which is calculated using

AHP techniques outside the K-shelf software. The initial values of AHP priority, company prioritisation, selected KVA and load of importance were manually obtained from designer input. The designer needs to click the update changed button to confirm any changes to those values. The three highest percentages were selected as KVAs encompass design performance, manufacturability and durability. Moreover, cost was also classified as a KVA due to company's preference choice which has the major impact in the creation of this order. All the customer values which are considered KVAs are marked as ticked boxes as shown in Figure 7(d). These marked KVAs are forwarded at once as the options of KVA drop-down list in the Insert System Target region as shown in Figure 7(e). In this step, the system targets of SJP are specified in order to explain how the KVA will be achieved (e.g., KVA design performance will be achieved when high pressure ≥ 400 psig, low pressure ≤ 205 psig and SJP has no moving parts). The designer has to select certain KVAs from the drop-down list and input system target into the system target text entry box and press add system *target* button to record SJP's system targets and their associated KVA. All the recorded system targets are presented as a column of a table inside system target region as shown in Figure 7(e).

4.4.2 Map SJP's design space in K-shelf

In this SJP case study, the K-shelf is working at the component level rather than subsystem level. Each component is associated to at least one component target. The component targets along with their level of innovation and feasible region are addressed in phase 2 'map design space' of the SBCE process model. Feasible targets for each component are defined to prevent over engineering and supporting the development of innovation. In K-shelf software, this phase is located in the map design space entry on the navigation bar. Once the user selects Map Design Space entry, K-shelf will display three regions in the main window: subsystem/component targets, subsystem/component level of innovation and feasible regions of design space. Activity 2.1 in the SBCE process to identify subsystem target is represented in the K-shelf software as subsystem/component targets region. Component targets are recorded in a similar way as system target as shown in Figure 7(e). The only difference is that in the system target region, system targets were added against KVAs, while in the subsystem/component target region, component targets are added against components, e.g., nozzle, mixing tube, mount, body or flange.

Activity 2.2 in the SBCE process to decide on level of innovation to subsystem is presented in the K-shelf as subsystem/component level of innovation region as shown in Figure 8(a). Each component is assigned with the following level of innovation: no changes, low, medium and high which are colour-coded in grey, green, yellow and red respectively. User needs to press the update changes button to commit changes of any level of innovation revision. Activity 2.3 in the SBCE process to define feasible regions of design space is presented in the K-shelf as feasible regions of design space region as shown in Figure 8(b). Components that have high level of innovation, for example the Nozzle in Figure 8(c) is enquired with predefined boundary questions as shown in Figure 8(d). Boundary of the SJP's system is filled up in a text entry field that accept conditional statements, e.g., discharge pressure ≥ 300 AND total length $\leq 2,000$ as shown in Figure 8(e). K-shelf saves these boundaries into the database and informs users if there are any previous projects that fit the boundaries. In this case, there was one

comprised previous project obtained from the industrial collaborator as shown in Figure 8(f).

Figure 8 K-shelf demonstrates design space mapping activity in SBCE process (see online version for colours)

Subsystem/Component Level of Innovation Update Changed

Component	Level of Innovation
Body	High
Flange	No changes
Mixing tube	Medium
Mount	Low
Nozzle	High

1 - 5 **A**

Feasible Regions of Design Space

System Boundaries Calculate

Reference: SJP_SYSTEM

E $h_{pressure} \geq 350$ and $discharge_{pressure} \geq 320$ and $total_{length} \leq 2000$

F There are 2 previous surface jet pump system falls into specified boundaries.

Subsystem/Component Boundaries Update Changed

Nozzle angle (deg)	17.5
Inside diameter (mm)	131
Nozzle length (mm)	445
Tip diameter (mm)	4128

D **B**

4.4.3 *Develop SJP's concept set in K-shelf*

Activity 3.1 in the SBCE process to extract design concepts is presented in the K-shelf as the design concept extraction region. It discloses the identified SJP previous project that falls into specified boundaries as aforementioned in Figure 8(f). The components of nozzle, body and mixing tube of this previous design became the basis of design which is named as original components in this case study. The system boundaries, component targets and component boundaries were considered during generation of the alternative design. Activity 3.2 in the SBCE process to create sets for subsystems is presented in the K-shelf as components generation region which allows the designer to generate the sets of component designs, incorporating the previous designs and newly generated designs as shown in Figure 9(a). In the first row of the component generation region is the basis of nozzle design, namely N1 – original. This original design is acquired from previous project. In this case study, designers managed to create nine new nozzle designs, hence in total ten nozzles were considered. The nozzles are: N1 – original, N2 – De Laval, N3 – shield, N4 – angle tip, N5 – asymmetric, N6 – bi-nozzle, N7 – multijet, N8 – parabolic, N9 – riffle and N10 – sharp tip. A selection of them is shown in Figure 9(a). The body and mixing chamber components were also developed; there were two new bodies and one new mixing tube.

During Activity 3.2 in the SBCE process to create sets for subsystems, 60 potential solutions were generated as the result of multiplication of ten nozzles, three bodies and two mixing tubes. Activity 3.3 in the SBCE process to explore subsystem sets is presented in the K-shelf as a possible alternative components region which allows designers to evaluate conceptual solutions as shown in Figure 9(b). In the possible alternative components region, all possible alternative component design concepts are presented as the combination of nozzle, mixing tube and body conceptual designs. The designer selects the most appropriate conceptual design based on three criteria in the KVA (i.e., design performance, manufacturability and cost). Some conditional expressions were applied in the possible alternative components region, for example, feasible nozzles will be carried on SJP development if at least two criteria were selected and only if the design performance criterion was selected as highlighted in Figure 9(b).

In terms of design performance, the designer refers to the result of analysis of SJP's flow motions that were carried out using computational fluid dynamic (CFD) software. The results of the CFD analysis are stored in K-shelf as a portable document format (PDF) attachment. Design rationales behind particular decisions made by the designer were also captured in the possible alternative components region. The K-shelf facilitates the designer to capture the components' design rationale regardless of their feasibility. By clicking the record design rationale button as shown in Figure 9(b), the design rationale capturing dialog will be initiated. For instance, the design rationale behind nozzle N5 – asymmetric tip was captured in an iterative interrogative five-whys dialog to record the cause-and-effect relationship underlying a particular decision as shown in Figure 9(c). SJP design rationales were based on empirical data acquired during the case study or argumentation among design participants. The K-shelf allows designers to link supporting evidence of design rationale as industry standards or guidelines, empirical studies or previous literatures.

Figure 9 K-shelf demonstrates concept set development activity and design rationale capturing in SBCE process (see online version for colours)

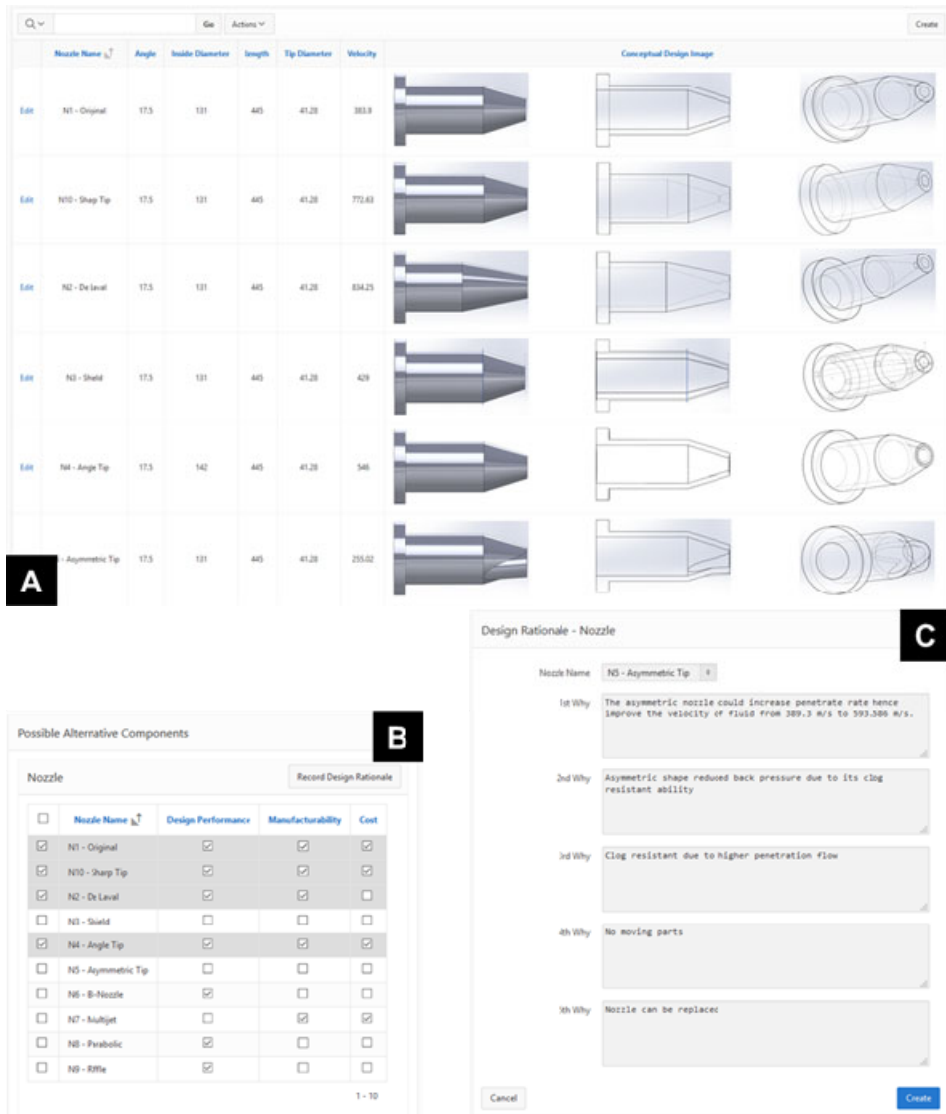

4.5 K-shelf supports comparisons among sets of SJP design solutions

The K-shelf is designed to support comparison among sets of solutions which is essential to narrow down the set of solutions. During the SBCE process, multiple solutions are explored simultaneously. Possible solutions might include numerous designs, different technologies, or a range of parameter values. The K-shelf supports this exploration, by capturing information about multiple solutions and allowing the user to navigate across options and explore them with appropriate views throughout the SBCE process.

Figure 10 The K-shelf demonstrates comparison of set of conceptual design (see online version for colours)

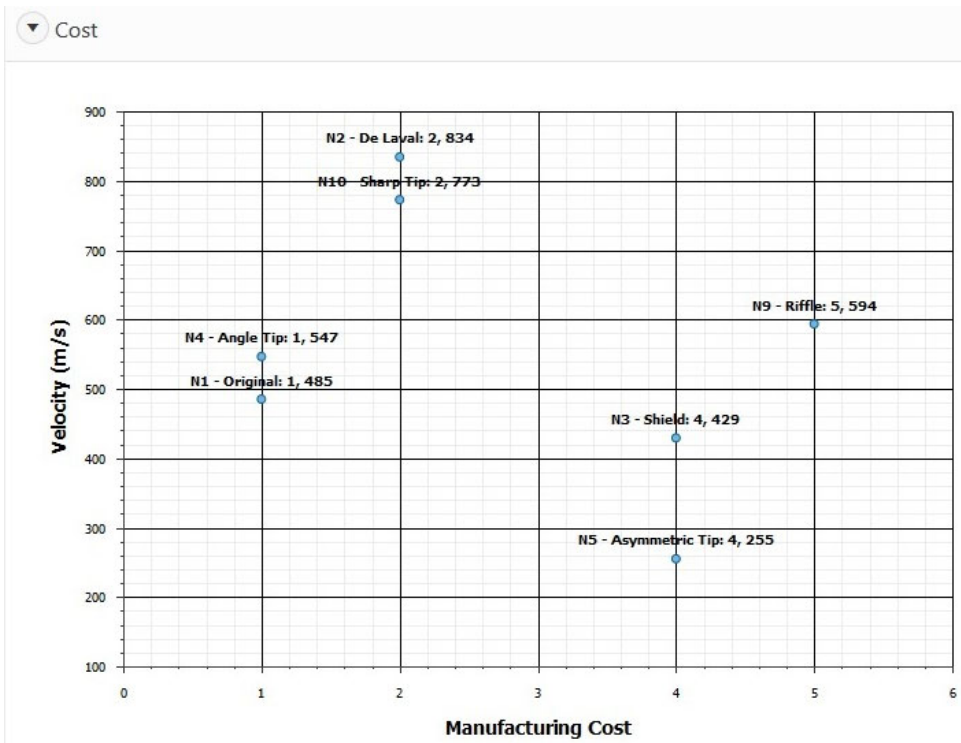

Another capability included in the K-shelf software, is the provision of diagrams and representation that support the comparison of different design solutions. One particular diagram that has been highlighted as essential for SBCE is the TOC. The TOC presents the behaviour of multiple solutions along critical performance axes for comparison. TOCs were generated using components' information as shown in Figure 10. To plot nozzle physics-based TOC, the following indicators were used:

- 1 nozzle downstream velocity (m/s) as a parameter related to design performance
- 2 manufacturing cost scaled from 1 to 5, where 1 is the cost of the original design and 5 is the highest cost
- 3 manufacturing complexity scaled from 1 to 5, where 1 is the manufacturing complexity of the original design.

The K-shelf is designed to support comparison among set of solution which is needed in order to assist the narrowing of set of solutions. During SBCE process, multiple solutions are explored simultaneously. Possible solutions might include numerous designs, different technologies, or a range of parameter values. The K-shelf supports this exploration, by capturing information about multiple solutions and allowing the user to navigate across options and explore them with appropriate views throughout the SBCE process. As it could be seen in Figure 10, there are four design solutions of the nozzle in the feasible area; these are N1, N2, N4, and N10. Hence, with the capability of the

K-shelf software to compare the set of solution, the number of the nozzle designs was narrowed down from 10 to 4.

5 Conclusions and future work

The research described in this paper was conducted to develop the concept of K-shelf, to enable its application into SBCE, and to demonstrate the concept via web-based software. The result from the research suggests that the implementation of a right knowledge environment will enhance SBCE application significantly. It has not escaped our notice that a great number of works of knowledge-based engineering in PD are successful. However, these works were mainly relying on domain knowledge of particular aspects, e.g., process, resources, etc. Previous research related to SBCE has focused on theory and industrial applications, with some attention on supporting methods. In this paper, the research focuses on capturing and storing design rationale in a well-structured manner and to support the comparisons among sets of design solutions and its provision to support SBCE.

The knowledge in SBCE is distinct in respect of there is more than one designs put forward. As the design progresses, the set of design is gradually narrowed based on the knowledge gained and design decision rationale are captured. While the design decision rationale of one of these designs is not suitable for the project under consideration, it might be useful for parallel project or future project. Thus, design decision rationale needs to be captured and saved for future use. There is no work addressing this issue as of yet; therefore, the concept of K-shelf is important for improvement of the SBCE application.

Because of the challenging aspect of SBCE, the K-shelf is developed with some capabilities, e.g., supports set of design generation, support set of design comparison, and captures design decision rationale. These capabilities are related to each other and have been demonstrated to industrial collaborator to evidence the significance of knowledge-based environment in supporting the SBCE application.

During the case study, the K-shelf helped designers to identify suitable design concepts. The K-shelf also helped to show designers how rapidly solution sets could be reduced to a manageable number; this was previously considered to be far more extensive an activity. The capability of K-shelf to capture design rationale was considered a valuable contribution, as it forces designers to capture tacit knowledge during a project, rather than as an additional piece of work.

The proposed software architecture is suitable for the knowledge environment in SBCE application, particularly for a company that practices multiple SBCE projects as shown in Figure 4. For example, the company in the case study is also developing other variant of SJP for offshore purpose that utilises similar component as onshore SJP addressed in this research. Schema object inheritance facilitates reusability and is an important concept of object-oriented approach as shown in Figure 5. Hence, the development of the K-shelf software can reuse the attributes and methods of the existing class. The K-shelf's GUI compatibility in various devices and platforms were also tested in the company. For example, the K-shelf software can be accessed through handheld device to support designer's mobility in the company site as shown in Figure 11.

Figure 11 The K-shelf is accessed using handheld device (see online version for colours)

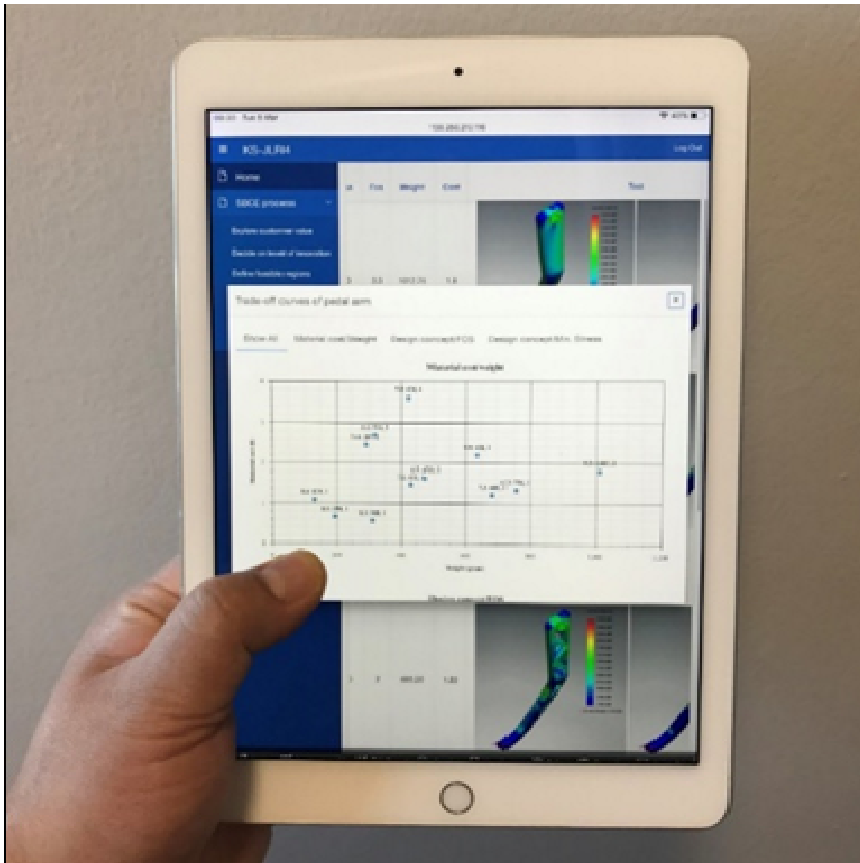

The theoretical contributions of this research are:

- 1 the K-shelf concept developed including detailed description of its capabilities to provide a suitable knowledge environment to enable an effective SBCE application
- 2 filling the gap of research in SBCE by exploring and explaining the underlying mechanism of how knowledge provision enables an effective SBCE application with the support of K-shelf
- 3 the advanced perspective and principles of design decision rationale capture in a structured manner to be used for future reuse in SBCE application
- 4 the K-shelf software developed to demonstrate K-shelf capabilities implemented in a proposed information technology environment
- 5 two K-shelf industrial case study applications, providing empirical evidence regarding the transformation towards a knowledge environment to enable an effective SBCE application.

The managerial contributions of this research are:

- 1 The implementation of the K-shelf software that is shown in Section 4.4 and Section 4.5 helped the company to develop novel design concepts within the SBCE application. In the same time, the K-shelf concept helped the company to have sustainable knowledge environment and practices in developing, deploying and protecting company strategic knowledge resources; design decision rationale and visualisation of TOC.
- 2 The SJP case study shows the application of SBCE process model in the real scenario. This case study has benefited the company by shifting its current PD process from a paper-based SBCE process to the K-shelf software as their knowledge environment. The K-shelf software assists the designers to explore the possible design within the design space without any difficulties from the current PD practices. The K-shelf software provided the designers with design rationale knowledge and TOC visualisation to help them made the right design.
- 3 The K-shelf concept along with the introducing of SBCE application has improved the probability of project success increased from 33% to 96% success rate. The design failure also improved from 0.8 to 2.4 successful designs.

A concept for capturing and storing design rationale in a well-structured manner and to support the comparisons among set of design solutions was defined and a software demonstrator was developed and implemented in a case study with positive results. The K-shelf demonstrator, however, was developed for a particular product and case study. In future, a K-shelf which is product independent would be helpful to a wider audience. To achieve this, more extensive research will be required to understand and categorise the key knowledge that must be captured and provided to support SBCE application.

References

- Aikhuele, D.O. and Oluwadare, G. (2019) 'Hybrid fuzzy inference system for evaluating lean product development practice', *Evolving Systems*, Vol. 10, No. 2, pp.249–259.
- Al-Ashaab, A. and Sobek, D.K. (2013) 'Lean product and process development: a value creation paradigm that goes beyond lean manufacturing', *International Journal of Computer Integrated Manufacturing*, Vol. 26, No. 12, pp.1103–1104.
- Al-Ashaab, A., Golob, M., Attia, U.M., Khan, M., Parsons, J., Andino, A., Perez, A., Guzman, P., Onecha, A., Kesavamoorthy, S., Martinez, G., Shehab, E., Berkes, A., Haque, B., Soril, M. and Sopolana, A. (2013) 'The transformation of product development process into lean environment using set-based concurrent engineering: a case study from an aerospace industry', *Concurrent Engineering*, Vol. 21, No. 4, pp.268–285.
- Al-Ashaab, A., Golob, M., Oyekan, J., Araci, Z.C., Khan, M., Deli, D. and Al-Ali, E. (2014) 'Flying into aerospace's next generation', *Industrial Engineer*, Vol. 46, No. 10, pp.38–43.
- Araci, Z.C., Al-Ashaab, A. and Maksimovic, M. (2016) 'Knowledge creation and visualisation by using trade-off curves to enable set-based concurrent engineering', *Electronic Journal of Knowledge Management*, Vol. 14, No. 1, pp.75–88.
- Baxter, D., Gao, J., Case, K., Harding, J., Young, B., Cochrane, S. and Dani, S. (2008) 'A framework to integrate design knowledge reuse and requirements management in engineering design', *Robotics and Computer-Integrated Manufacturing*, Vol. 24, No. 4, pp.585–593.
- Canbaz, B., Yannou, B. and Yvars, P.-A. (2014) 'Resolving design conflicts and evaluating solidarity in distributed design', *IEEE Transactions on Systems, Man, and Cybernetics: Systems*, Vol. 44, No. 8, pp.1044–1055.

- Correia, A.T., Stokic, D. and Faltus, S. (2014) 'Mechanism for communication and knowledge sharing for set-based concurrent engineering', *International Journal of Product Development*, Vol. 19, Nos. 5/6, pp.328–347.
- Dresch, A., Lacerda, D.P. and Antunes Jr., J.A.V. (2015) *Design Science Research*, Springer International Publishing, Cham.
- Essamlali, M.T.E., Sekhari, A. and Bouras, A. (2017) 'Product lifecycle management solution for collaborative development of wearable meta-products using set-based concurrent engineering', *Concurrent Engineering*, Vol. 25, No. 1, pp.41–52.
- Gray, A.W. and Singer, D.J. (2015) 'Applied set-based communication and negotiation systems', *Naval Engineers Journal*, Vol. 127, No. 3, pp.61–72.
- Hemlin, S., Allwood, C.M. and Martin, B.R. (2008) 'Creative knowledge environments', *Creativity Research Journal*, Vol. 20, No. 2, pp.196–210.
- Jeang, A. and Liang, F. (2012) 'An innovation funnel process for set-based conceptual design via DOE exploration, DEA selection and computer simulation', *International Journal of Production Research*, Vol. 50, No. 23, pp.6792–6810.
- Kennedy, B.M., Sobek, D.K. and Kennedy, M.N. (2014) 'Reducing rework by applying set-based practices early in the systems engineering process', *Systems Engineering*, Vol. 17, No. 3, pp.278–296.
- Khan, M., Al-Ashaab, A., Doultsinou, A., Shehab, E., Ewers, P. and Sulowski, R. (2011) 'Set-based concurrent engineering process within the LeanPPD environment', in *Improving Complex Systems Today*, pp.433–440, Springer, London.
- Khan, M.S., Al-Ashaab, A., Shehab, E., Haque, B., Ewers, P., Sorli, M. and Sopelana, A. (2013) 'Towards lean product and process development', *International Journal of Computer Integrated Manufacturing*, Vol. 26, No. 12, pp.1105–1116.
- Lee, J. (1997) 'Design rationale systems: understanding the issues', *IEEE Expert*, Vol. 12, No. 3, pp.78–85.
- Liker, J.K. and Morgan, J.M. (2006) 'The Toyota way in services: the case of lean product development', *The Academy of Management Perspectives*, Vol. 20, No. 2, pp.5–20.
- Liker, J.K., Sobek, D., Ward, A.C. and Cristiano, J.J. (1996) 'Involving suppliers in product development in the United States and Japan: evidence for set-based concurrent engineering', *IEEE Transactions on Engineering Management*, Vol. 43, No. 2, pp.165–178.
- Maksimovic, M. (2013) *Lean Knowledge Life Cycle Framework to Support Lean Product Development*, Cranfield University, UK.
- Maksimovic, M., Al-Ashaab, A., Shehab, E., Flores, M., Ewers, P., Haque, B., Furian, R., von Lacroix, F. and Sulowski, R. (2014) 'Industrial challenges in managing product development knowledge', *Knowledge-Based Systems*, Vol. 71, pp.101–113.
- Maksimovic, M., Al-Ashaab, A., Sulowski, R. and Shehab, E. (2012) 'Knowledge visualization in product development using trade-off curves', *2012 IEEE International Conference on Industrial Engineering and Engineering Management (IEEM)*, pp.708–711.
- Malak, R.J., Aughenbaugh, J.M. and Paredis, C.J.J. (2009) 'Multi-attribute utility analysis in set-based conceptual design', *Computer-Aided Design*, Vol. 41, No. 3, pp.214–227.
- Maulana, M.I.I.B.M., Al-Ashaab, A., Flisiak, J.W., Araci, Z.C., Lasisz, P.W., Shehab, E., Beg, N. and Rehman, A. (2017) 'The set-based concurrent engineering application: a process of identifying the potential benefits in the surface jet pump case study', *Procedia CIRP*, Vol. 60, pp.350–355.
- Ramesh, B. and Sengupta, K. (1995) 'Multimedia in a design rationale decision support system', *Decision Support Systems*, Vol. 15, No. 3, pp.181–196.
- Regli, W.C., Hu, X., Atwood, M. and Sun, W. (2000) 'A survey of design rationale systems: approaches, representation, capture and retrieval', *Engineering with Computers*, Vol. 16, Nos. 3–4, pp.209–235.
- Sobek, D.K., Ward, A.C. and Liker, J.K. (1999) 'Toyota's principles of set-based concurrent engineering', *Sloan Management Review*, Vol. 40, No. 2, pp.67–83.

- Van den Bosch, F.A.J., Volberda, H.W. and de Boer, M. (1999) 'Coevolution of firm absorptive capacity and knowledge environment: organizational forms and combinative capabilities', *Organization Science*, Vol. 10, No. 5, pp.551–568.
- Wang, J. and Terpenney, J. (2003) 'Interactive evolutionary solution synthesis in fuzzy set-based preliminary engineering design', *Journal of Intelligent Manufacturing*, Vol. 14, pp.153–167.
- Ward, A. and Sobek, D. (2014) *Lean Product and Process Development*, 2nd ed., Lean Enterprise Institute, USA.
- Ward, A., Liker, J.K., Cristiano, J.J. and Sobek, D.K. (1995) 'The second Toyota paradox: how delaying decisions can make better cars faster', *Sloan Management Review*, Vol. 36, No. 3, pp.43–61.
- Ward, A., Shook, J. and Sobek, D. (2007) *Lean Product and Process Development*, Lean Enterprise Institute, Cambridge, MA, USA.
- Wasim, A., Shehab, E., Abdalla, H., Al-Ashaab, A., Sulowski, R. and Alam, R. (2013) 'An innovative cost modelling system to support lean product and process development', *The International Journal of Advanced Manufacturing Technology*, Vol. 65, Nos. 1–4, pp.165–181.
- Zhu, Z., Nagalingam, S. and Hsu, H-Y. (2011) 'Toward a creative problem-solving methodology with knowledge provision', *Applied Artificial Intelligence*, Vol. 25, No. 9, pp.836–881.

The development of knowledge-shelf to enable an effective set-based concurrent engineering application

Suwanda, Supriana

2020-11-11

Attribution 4.0 International

Suwanda S, Al-Ashaab A, Beg N. (2020) The development of knowledge-shelf to enable an effective set-based concurrent engineering application. *International Journal of Internet Manufacturing and Services* , Volume 7, Issue 4, 2020, pp. 407-427

<https://doi.org/10.1504/IJIMS.2020.110256>

Downloaded from CERES Research Repository, Cranfield University