

Modelling Product and Partners Network Architectures to Identify Hidden Dependencies

S. Zouggar, M. Zolghadri, Ph. Girard

IMS-LAPS, Bordeaux University, 351, cours de la libération, Talence 33405, France

Salah.zouggar@ims-bordeaux.fr

Abstract

This paper explores mutual dependencies between partners of a New Product Design (NPD) project during the realization phase. It highlights bidirectional influences between components and partners. Linking product and network architectures is achieved through gBOMO (generalised Bill Of Materials and Operations) that allows expressing product components use and partners interventions in the network. We develop an approach to achieve building *Dependency strength matrix*. Analysing this matrix reveals obvious and hidden dependencies between partners which should be anticipated in early stages of the NPD project. The approach is illustrated through its application on an engine.

Keywords:

Partners network, Product architecture, Logical dependencies, NPD project.

1 INTRODUCTION

In the current economic competitive context, companies are looking for development of sustainable partnerships through a sustainable network of partners commonly called supply chain, to increase their responsiveness and innovation capability.

Such a partnership is crucial for SMEs whose means and capacities are limited. However, taking part in a partnership, means sharing not only opportunities but also risks. Therefore the question of Supply Chain design is crucial for all companies and especially for SMEs which have limited resources. The scientific literature contains lots of work in this field, see for example [1]. More recently Meixella and Gargeya provided an interesting literature review [2]. The criticality in designing supply chain, is held in the difficulties to know how to decide among feasible decisions such as the number and location of production facilities, the amount of capacity at each facility, the assignment of each market region to one or more locations, supplier selection for sub-assemblies and components and materials, in [3]. [4] in [5] distinguishes plant sizing, product/material selection, and allocation decisions that belong to the strategic level and tactical decisions such as production and inventory levels.

However, often companies should cope with real failures occurring at advanced stages of the NPD project due either to inadequate components or to partnership dysfunctions undetected in early stages of decision-making cascades. [6] consolidates this idea arguing that the efficiency of various collaborative networks (with customers, suppliers, competitors) such as Supply Chains influences the success of the introduction of new products. Their study highlights that technological collaboration within the Supply Chain has a positive impact on innovation capability and proves that the suppliers are important contributors to the product innovation. Also Girard and Robin in [7] point out the necessity to focus not only, on product, but also on

relations between designers. They argue that the design process is an outcome of collaboration process and propose a methodology to manage these collaborations. Studying design and development of partners' network while the product is designed and developed, is therefore a relevant way for identification of future potential dysfunctions. This study presents the Supply Chain design and development from the point of view of that company which launches the NPD project, called here Focal Company. To do so, it is necessary to identify first links between the architectures of the product and the network or Supply Chain. Based on these links, logical and temporal dependencies between partners and the focal company are identified and qualified. It allows highlighting *hidden dependencies* within the supply chain. The architectures of the product and the network are modelled through interconnected formalisms which reveals direct and indirect *interfaces* intra-product (between its components), intra-network (between its partners). This paper is organised as follows. A brief state-of-the-art is presented in section two. Sections three and four present necessary concepts of the approach. Section five describes the use case study. Some conclusions and perspectives will end the paper.

2 SOME FUNDAMENTAL AND RELATED WORKS

Ulrich in [8] says: "*Product architecture is defined as the scheme by which the function of product is allocated to physical components*". He reminds that product architecture consists of not just certain number of components, but the way that they work together and assembled, as well. The notion of interaction between components is also evoked by [9]. The complexity is emerged from these relationships often hard to identify, to model, and thorny to monitor. Therefore, modelling mutual dependency links is of utmost importance. This point is also underlined by [10]. He argues that the product architecture, when properly defined and articulated, can

serve as a coordination mechanism. Various product characteristics have consequences (enabling or constraining) on decisions made during the product life cycle. Roughly speaking, two kinds of architectures can be distinguished: Modular and Integral, [8], [11], [12]. A modular architecture includes a one-to-one mapping from functional elements to physical components of the product. Modules are independent and have clear interfaces between them [13]. According to [14] the modularity is an interesting way of providing flexibility in technical development without entire modification of the design. Hölltä and Otto in [15] outline the characteristic of good module. They argue that it is the facility with which the module design could be redesigned without impacting its interfaces and the rest of product. Integral architectures include a complex mapping between functional elements and physical components. In [10] he uses a Function-Component Allocation matrix, FCA in short, defining this mapping. Product's functions are listed in columns and components in rows. Through this approach, he contributes to provide a descriptive product architecture framework (and the way it is linked to many decisions across the domains of product, process and supply chain). Current research in the literature provides considerable tools helping to coherently identify and achieve technical reliable solutions answering technical specifications. The Design Structure Matrix (DSM) is one of them. Used to represent the architecture, it has been studied extensively, for instance by [9], [16]. [17] uses this tool to model the interdependency and explicit likelihood, impact and risks on changing context with propagation effects.

3 MODULAR PRODUCT

3.1 Modelling the product architecture

The concept of product modularization shows that product is a complex system made up of many interacting parts. To simplify the complexity of the system, the product is designed as a set of sub-assemblies (sub-systems) so that their assembly constitutes the new product. Through product modularization, the manufacturer can create many products by assembling different sub-assemblies within a short product development lead time.

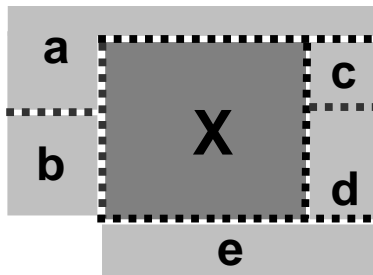

Figure 1: Product modules interfaces.

The product modularity influences the network architecture by imposing interfaces between pre-defined modules. The figure 1 shows a final product, X, provided by the focal company. X is the core of final product containing modules a, b, c, d and e made by 5 different partners. Interfaces are represented by dotted lines. For example, module (a) has three interfaces with X, (c) and (b) whereas module (c) interfaces with X, (a) and (d). Connections between parts of a product, authorized through interfaces, might be of different types: energy, movement and data [18]. Two other links between the modules can also be defined: *geometrical* constraints (they refer to all spatial positioning constraints of modules on the product) *physical* constraints (referring to all electromagnetic, thermodynamic, mechanical constraints). When two modules are interfaced it means

that one of the quoted connections exists. These connections are represented easily in the components linkage matrix.

	a	b	c	d	e
a	-	1	1	0	0
b	1	-	0	0	0
c	1	0	-	1	0
d	0	0	1	-	1
e	0	0	0	1	-

Table1: Components linkage matrix.

Based on this configuration, the goal is to model the corresponding realization process that requires the involvement of several collaborative partners. Therefore the next step consists of modelling the connections between the focal company and its partners (suppliers, sub-contractors) through gBOMO (generalised Bill-Of -Materials and Operations).

3.2 Generalized Bill-Of-Materials and Operations, gBOMO

Starting from traditional well known Bill-Of-Materials that enables to represent partially the product architecture, this concept is extended into gBOMO in order to link together product-network architectures. All potential connections must be outlined in order to perceive the gradual intervention of partners.

A BOM shows the participation of parts (subassemblies, intermediate parts, raw materials) in the production of parent part. The usefulness of BOM is perceived through its usage in master production planning. Generally, two kinds of BOM exists (Jiao et al,2000) [19]: eBOM (engineering BOM) and mBOM (manufacturing BOM), the distinction between the two is that an eBOM structures the way that a product is designed and according to Jiao it consists of functional assemblies of subsystems while mBOM defines the way that a product is produced. In both cases, the BOM enclose the number of items (raw materials or subassemblies) used to produce the parent sub-assembly. BOM is represented in a simple way through a table where the components are put close to the parent assembly with corresponding number of participation (quantity of components) to do one unit of parent assembly.

Beyond the concept of BOM in [19] concept of BOMO is introduced by a fusion of the BOMs and Bill-Of-Operations (BOO) to facilitate better production planning and control, order processing and engineering change control. A BOO represented by process flow diagram gives the production structure of a given product. Hence the fusion of these two concepts, the BOMO could specify the *sequence of production operations* required for making an intermediate part/subassembly or a final product as well as the materials and resources required at each operation. A Kitting activity is added by Jiao before any operation consisting of preparing all necessary components, tools and fixtures.

3.3 Generalized Bill-Of-Materials and Operations, gBOMO

The gBOMO concept (see Figure2) was introduced in [20] as an adaptation of Jiao BOMO [19]. This representation gathers jointly technical data of BOO (Bill Of Operations) and BOM (Bill Of Materials) of the considered product. The BOM allows perceiving the connections between the focal company and a subset of its major suppliers.

However the BOO allows the definition of the collaboration with sub-contractors. It also contains complementary data describing the sequence of synchronisation situations. The employment of BOMO is justified by the purpose of giving enough data to the

managers supporting them for the production planning and control tasks. That is the reason why the kitting activity (preparing materials, tools, resources before any activity specially assembly) is also used.

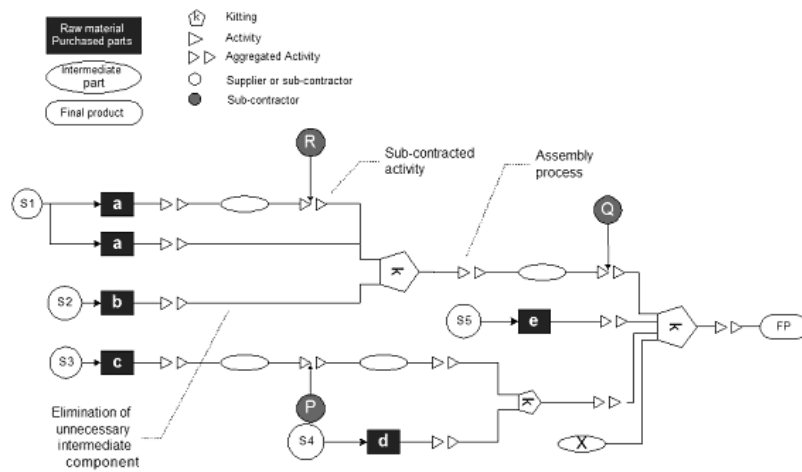

Figure 2: gBOMO representation of the product X (From [20])

The following points represent the differences of gBOMO comparing to BOMO concept:

- Purchased parts and raw materials are gathered in one class.
- The sub-contracted processes are directly connected to the external partner by a bi-lateral connection.
- The systematic use of kitting process is neglected. This process is maintained for assembly processes.
- When no confusion is possible, before the kitting process the intermediate parts are not represented in the model.

The idea of the formalism is to represent technical data (BOO and BOM) of a product jointly from a given point of view. It means that the formalism is applied based on the analyst-manager decision level; the aggregation mechanisms [21] could be used in this modelling approach too.

3.4 Works connection graph

The gBOMO formalism as introduced previously, allows visualizing the expected execution of realization process of product and its requirements in terms of components, data and external interventions. For observing chronologically the necessity of intervention of different involved actors in the realization process, it is possible to identify a works connection graph.

For obtaining the works connection graph (see Figure.3) from gBOMO, the next steps ought to be followed:

- Associate with each activity of shipping, subcontracting and assembling a node in the network. Each node of this graph represents a work (or activity). These activities vary according to the nature of the performed operations: shipping, subcontracting, assembling. In other words, these nodes can be seen as junction points where the intervention of concerned partners is required to finalize the current activity and to allow the execution of the next one.
- Two adjacent nodes involved in the same workflow are linked by an edge. The edges of the graph represent the antecedence relationship between various activities.

- Intermediate activities which do not require partners' participation are neglected.

Junction points identified in this graph are then 1) shipping: J1, J2, J3, J4, J5, J6, 2) subcontracting: J7, J8, J11, 3) assembly: J9, J10, J12.

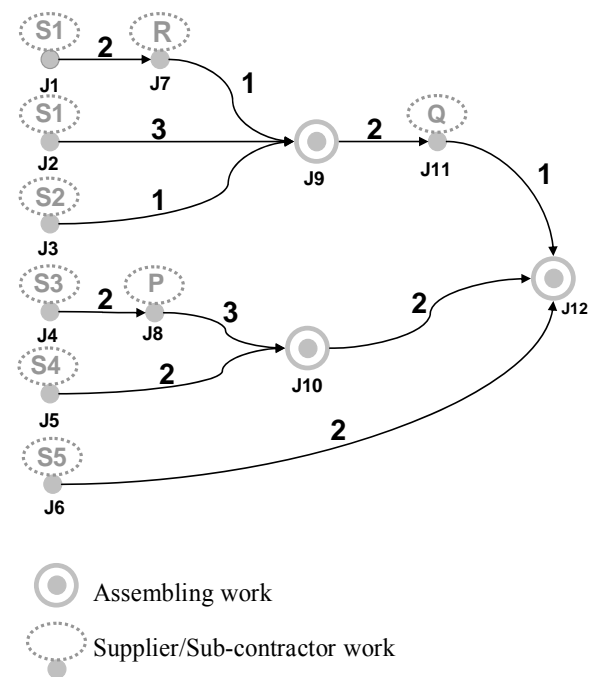

Figure 3: Works connection graph

In works connection graph, edges valuation will be of great help. They distinguish different relationships between actors (the focal company and partners). The valuation between two adjacent nodes A and B, expresses their mutual influence or the criticality level in their complementarity. In a real application case, these valuations are obtained after discussions and brainstorming among company's experts. The scale of criticality is defined as follow: 1 stands for High criticality, 2 stands for average criticality, 3 stands for low criticality.

For example: the value of edge between J1 and J7 equals to 2, it means that the work performed in node J1 has an average criticality for work completion at junction point J7 and vice versa.

4 PARTNERS DEPENDENCY MODELLING

In [20] it is suggested to follow two steps before analysing the network dependency: gBOMO identification, synchronization graph. The situation is different for works connection graph and edge valuation. Through the interpretation of gBOMO into works connection graph, the focus is put on complementarity in transformations made by various partners. Edge valuation gives relevant linkage between adjacent partners, useful for analysing all dependencies, hidden or explicit, between partners.

The global approach to determine these dependencies is illustrated in figure.4. Once the gBOMO identified, the works connection graph is extracted from it using those rules presented in §3.4. The edges are then valued. From this model, the modelling of partners' dependencies can begin. After obtaining an Amplified Work Criticality Level matrix $\psi(i, j)$ the Partners dependency strength matrix is deduced.

By extracting supplier's dependency strength matrix and by comparing it to Product components linkage matrix, we enable to highlight the hidden dependencies between partners.

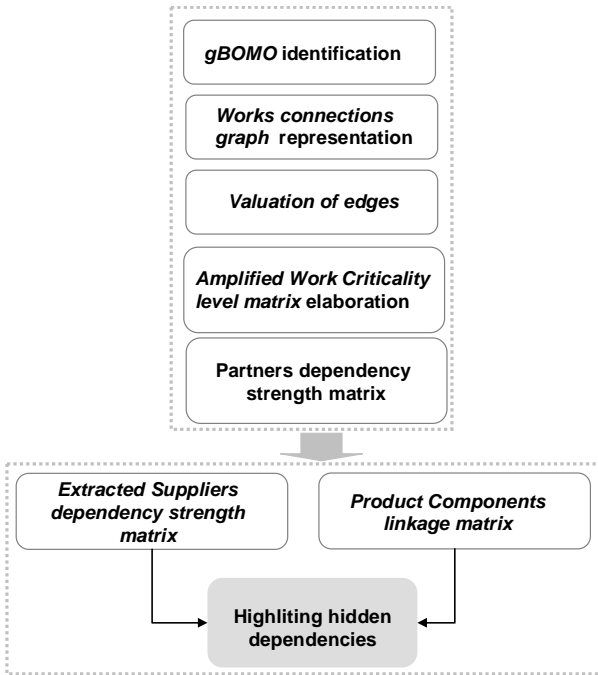

Figure 4: Modeling approach

4.1 Amplified Work Criticality Level Matrix

The Amplified Work Criticality Level (AWCL) matrix determines the mutual criticality among two partners, not only adjacent ones but every couple of partners. It is assumed that criticality is amplified (multiplication of dependency values of the edges) along the paths of the graph. This amplification models the criticality of the value added to items along the workflow. This reflects the fact that: 1) any little error or mistake made at the beginning of a workflow could have important influences on the final result of the workflow, 2) the later these errors, mistakes or dysfunctions are detected the more will be the cost of correction activities.

The AWCL matrix is defined then as:

$$\psi(i, j) \quad i, j \in \{Partners\}.$$

The assessment of paths (P) between two entities (i,j) constitutes the value of criticality. It is done by evaluating the value of the path of these entities to the next common junction point. For instance, J12 is the next common junction between S1, S5 (see Figure.5).

(i) and (j) both contribute on the realization of an activity. It is chosen to use the minimal path value between all possible paths. This minimal value corresponds to the highest criticality, because the highest criticality value determines the real impact that the work of the partner can have on the other in whole work realization.

When a partner intervenes at different steps as S1 does, involving different criticality values, the minimum value representing the highest criticality is chosen. It allows taking and amplifying potential risks within the project. For instance, there are two paths between S1 and its next common junction point J12 with S5. The calculation is then as follows:

$$P_{S1 \rightarrow J12} = J1 \rightarrow J7 \rightarrow J9 \rightarrow J11 \rightarrow J12 = 2 \times 2 = 4$$

$$P_{S1 \rightarrow J12} = J2 \rightarrow J9 \rightarrow J11 \rightarrow J12 = 3 \times 2 = 6$$

$$P_{S5 \rightarrow J12} = J6 \rightarrow J12 = 2$$

$$\psi_{(1,5)} = \min \{ \min(4,6), 2 \} = 2$$

To summarize the calculation of the AWCL matrix, we can write:

$$\psi_{(i, j)} = \min \{ \min P_{(i \rightarrow \text{common junction})}, \min P_{(j \rightarrow \text{common junction})} \}$$

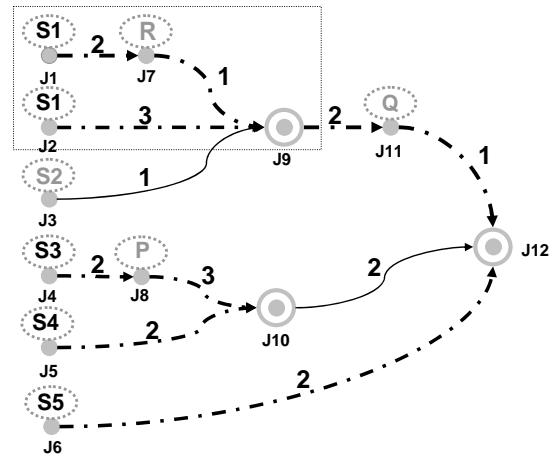

Figure 5: AWCL examples

In this way, the AWCL for all partners is found. These results are summarized in the table below.

	S1	S2	S3	S4	S5	P	Q	R	FC
S1	0	1	4	4	2	4	4	2	1
S2	1	0	2	2	2	2	2	1	1
S3	4	2	0	2	2	2	1	2	1
S4	4	2	2	0	2	2	1	2	1
S5	2	2	2	2	0	2	1	2	1
P	4	2	2	2	2	0	1	2	1
Q	4	2	1	1	1	1	0	2	1
R	2	1	2	2	2	2	2	0	1
FC	1	1	1	1	1	1	1	1	0

Table 2: AWCL matrix

Hypothesis:

- Focal company's work is highly critical to all of its partners. Then these links equal 1.
- The main diagonal of the matrix equal to 0.

4.2 Dependency strength matrix elaboration $\delta_{(i,j)}$

Dependency strength noted $\delta_{(i,j)}$ is defined as the value that characterizes the mutual dependency between partner i and partner j . As the criticality scale goes from 1: highest, 2: average, 3: Lowest, the minimal value of amplified criticality values obtained after calculation between any couple of partners represents the highest dependency existing between them. So, the dependency strength can be expressed as decreasing function of the criticality value: $\delta_{(i,j)} = \lceil \psi^{-1}(j,i) \rceil, \forall i, j$ (see Figure.6).

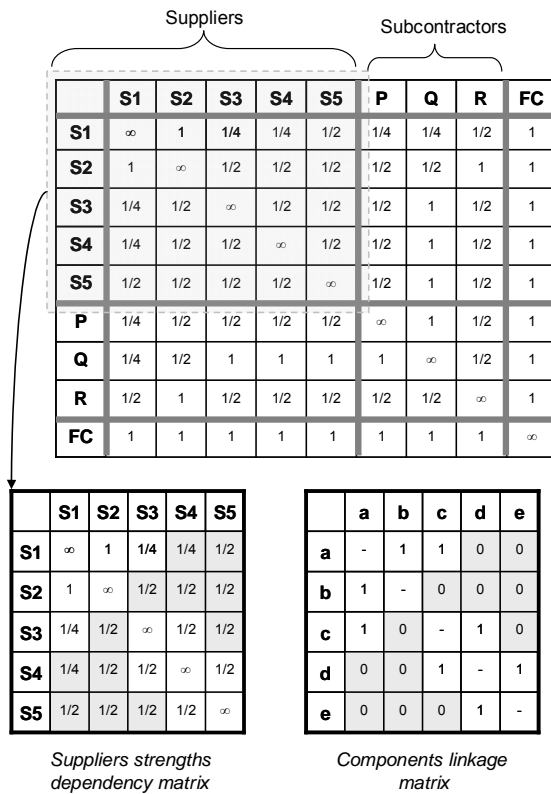

Figure 6: Dependency strength matrix

4.3 Analysis

According to the obtained results of this matrix, unsurprisingly, it can be noticed that all partners are more or less dependent to each other. Interesting observations can be deduced by comparing this latter matrix and the components linkage matrix representing some *hidden dependencies* (Figure.7).

The focus can be put only on suppliers and their dependency sub-matrix extracted from the global dependency strength matrix. The matrix is adjusted by replacing all values lower than 1/4 by 0 *considering that it is negligible*.

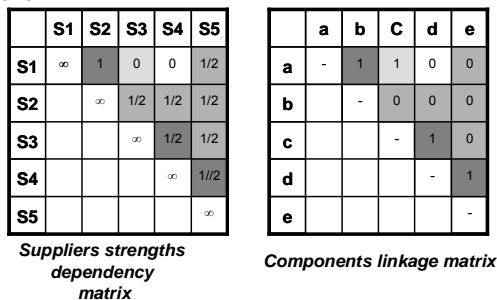

Figure 7: Matrices comparing

Different possible situations can be therefore identified resumed in the following table:

Links types Category	Supplier links	Components links
Category 1	Don't exist	Don't exist
Category 2	Don't exist	Exist
Category 3	Exist	Don't exist
Category 4	Exist	Exist

Table 3: Situations categorization

Category 1: This is not a critical case: no link between suppliers and no link between components. It does not require any specific attention (ex: S2 and S3 are not dependent and B and C are not linked).

Category 2: There is no dependency link between suppliers but the components that they supply are linked (ex: S1, S3 and a, c). These are the cases of hidden links and the most important representatives of potential dysfunctions. The focal company has to master manufacturing requirements for both suppliers concerning the realization phase by anticipating it within design process.

Category 3: Suppliers are dependent and the components that they supply are not linked. (ex: S1, S4 and a, d). Focal company has to define explicit design rules for each couple of dependent partners. Identify the way they have impacts on the works of each other. This impact can be in manufacturing capacity planning or direct / indirect temporal synchronization. Focal company has to be sure that the two partners handle their relationship and dependency in a face-to-face collaboration.

Category 4: When suppliers are dependent and the components that they provide are linked (S1, S2 and b, a). In this case, all dependencies are obvious and the focal company has specific procedures and treatment corresponding to this case.

Category 2 highlights hidden dependencies that it is interesting to exploit in the early phase of NPD project. It allows early consideration of constraints lies on realization phase ensuring coherent choices during the design phase according to network of partners working.

5 APPLICATION CASE

The application case is a simplified version of the structure of an engine. Here are given some of the basic components of the engine and their affectation to suppliers. The components linkage matrix is built according to the existing interfaces between components.

- S1 → C1: Steel
- S2 → C2: Iron
- S3 → C3: Piston
- S4 → C4: Connecting rod
- S5 → C5: Oil pump, Oil sump, Cylinder head gasket, Cylinder head cover
- S6 → C6: Flywheel
- S7 → C7: Cylinder head block
- S8 → C8: Bearing cap
- S9 → C9: Timing belt
- S10 → C10: spark plug

S11 → C11: alternator
 S12 → C12: Lead assy
 FC → X: Camshaft, Cranks haft, Cylinder block
 gBOMO of the engine is represented in figure 8. The realization process of the engine is well known, it allows

obtaining complete gBOMO. It is not always obvious to get a full knowledge of realization phase because of potential novelty to a known case. These adding imply a new linkages and dependencies not always perceptible at first view.

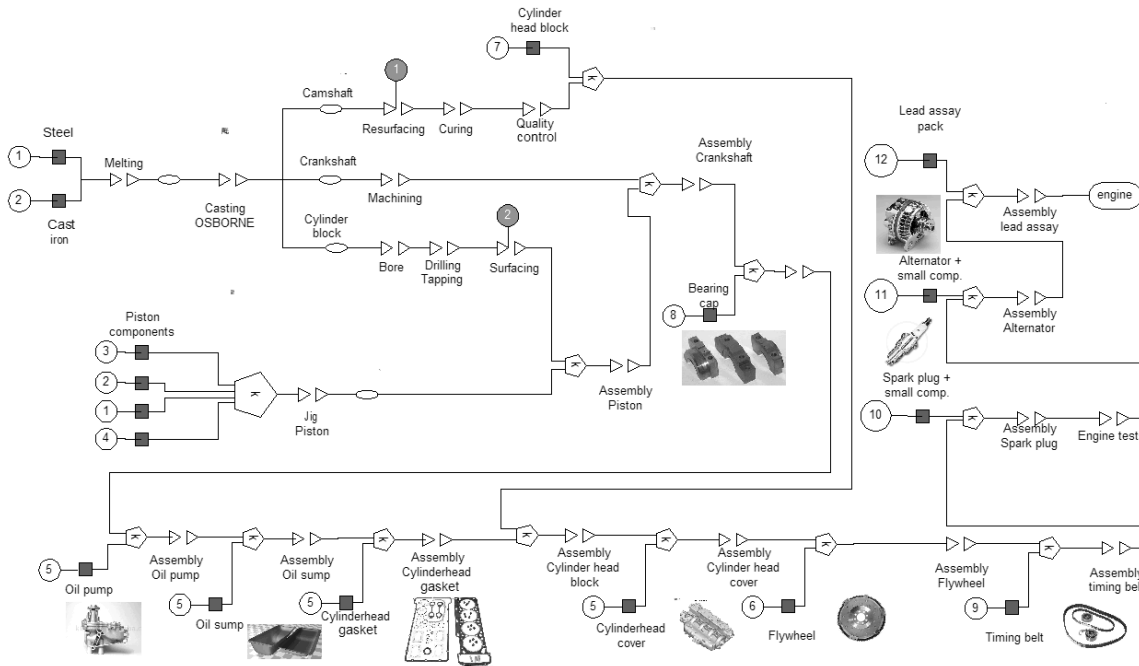

Figure 8: gBOMO of the Engine

The Works connection graph, extracted from the gBOMO, permits to explicit link value between each two adjacent partners implied in local work, (see figure 9) obtained according to the steps enounced in section 3.2 and by interviewing experts in mechanical engineering.

The developed approach is applied in the case study, obtaining gradually AWCL matrix, Dependency strength matrix, adjusted supplier's dependency matrix.

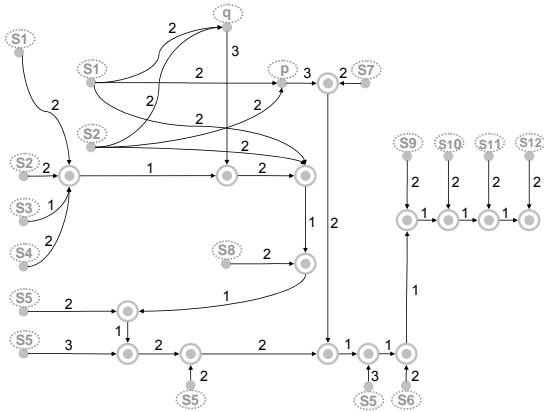

Figure 9: Works connection graph for Engine

	C1	C2	C3	C4	C5	C6	C7	C8	C9	C10	C11	C12	X
C1	-	1	0	1	1	0	0	0	0	0	0	0	1
C2	1	-	0	1	1	0	0	0	0	0	0	0	1
C3	0	0	-	1	0	1	0	1	0	0	0	0	0
C4	1	1	1	-	0	0	0	1	0	0	0	0	1
C5	1	1	0	0	-	0	1	0	0	0	0	0	1
C6	0	0	1	0	0	-	0	0	1	0	0	0	0
C7	0	0	0	0	1	0	-	0	0	0	0	0	0
C8	0	0	1	1	0	0	0	-	0	0	0	0	0
C9	0	0	0	0	0	1	0	0	-	0	1	1	0
C10	0	0	0	0	0	0	0	0	0	-	0	0	0
C11	0	0	0	0	0	0	0	0	1	0	-	1	0
C12	0	0	0	0	0	0	0	0	0	1	0	-	0
X	1	1	0	1	1	0	0	0	0	0	0	0	-

Table 4: Engine components linkage matrix

	S1	S2	S3	S4	S5	S6	S7	S8	S9	S10	S11	S12	P	Q	FC
S1	0	2	1	2	2	2	2	2	2	2	2	2	2	2	1
S2	2	0	1	2	2	2	2	2	2	2	2	2	2	2	1
S3	1	1	0	1	2	2	4	2	2	2	2	2	6	1	1
S4	2	2	1	0	2	2	4	2	2	2	2	2	6	2	1
S5	2	2	2	2	0	2	4	2	2	2	2	2	4	2	1
S6	2	2	2	2	2	0	2	2	2	2	2	2	2	2	1
S7	2	2	4	4	4	2	0	4	2	2	2	2	2	4	1
S8	2	2	2	2	2	2	4	0	2	2	2	2	6	2	1
S9	2	2	2	2	2	2	2	0	2	2	2	2	2	2	1
S10	2	2	2	2	2	2	2	2	0	2	2	2	2	2	1
S11	2	2	2	2	2	2	2	2	2	0	2	2	2	2	1
S12	2	2	2	2	2	2	2	2	2	2	0	2	2	2	1
P	2	2	6	6	4	2	6	2	2	2	2	0	6	1	1
Q	2	2	1	2	2	2	4	2	2	2	2	2	6	0	1
FC	1	1	1	1	1	1	1	1	1	1	1	1	1	1	0

Table 5: AWCL matrix

	S1	S2	S3	S4	S5	S6	S7	S8	S9	S10	S11	S12	P	Q	FC
S1	∞	1/2	1	1/2	1/2	1/2	1/2	1/2	1/2	1/2	1/2	1/2	1/2	1/2	1
S2	1/2	∞	1	1/2	1/2	1/2	1/2	1/2	1/2	1/2	1/2	1/2	1/2	1/2	1
S3	1	1	∞	1	1/2	1/2	1/4	1/2	1/2	1/2	1/2	1/2	1/6	1	1
S4	1/2	1/2	1	∞	1/2	1/2	1/4	1/2	1/2	1/2	1/2	1/2	1/6	1/2	1
S5	1/2	1/2	1/2	1/2	∞	1/2	1/4	1/2	1/2	1/2	1/2	1/2	1/4	1/2	1
S6	1/2	1/2	1/2	1/2	1/2	∞	1/2	1/2	1/2	1/2	1/2	1/2	1/2	1/2	1
S7	1/2	1/2	1/4	1/4	1/4	1/2	∞	1/4	1/2	1/2	1/2	1/2	1/2	1/4	1
S8	1/2	1/2	1/2	1/2	1/2	1/2	1/4	∞	1/2	1/2	1/2	1/2	1/6	1/2	1
S9	1/2	1/2	1/2	1/2	1/2	1/2	1/2	1/2	∞	1/2	1/2	1/2	1/2	1/2	1
S10	1/2	1/2	1/2	1/2	1/2	1/2	1/2	1/2	1/2	∞	1/2	1/2	1/2	1/2	1
S11	1/2	1/2	1/2	1/2	1/2	1/2	1/2	1/2	1/2	1/2	∞	1/2	1/2	1/2	1
S12	1/2	1/2	1/2	1/2	1/2	1/2	1/2	1/2	1/2	1/2	1/2	∞	1/2	1/2	1
P	1/2	1/2	1/6	1/6	1/4	1/2	1/2	1/6	1/2	1/2	1/2	1/2	∞	1/6	1
Q	1/2	1/2	1	1/2	1/2	1/2	1/4	1/2	1/2	1/2	1/2	1/2	1/6	∞	1
FC	1	1	1	1	1	1	1	1	1	1	1	1	1	1	∞

Table 6: Dependency strength matrix

The analysis of Suppliers strength dependency matrix compared to the components linkage matrix (see Table 7)

allows achieving the previously evoked categorization.

	C1	C2	C3	C4	C5	C6	C7	C8	C9	C10	C11	C12
C1	-	1	0	1	1	0	0	0	0	0	0	0
C2		-	0	1	1	0	0	0	0	0	0	0
C3			-	1	0	1	0	1	0	0	0	0
C4				-	0	0	0	1	0	0	0	0
C5					-	0	1	0	0	0	0	0
C6						-	0	0	1	0	0	0
C7							-	0	0	0	0	0
C8								-	0	0	0	0
C9									-	0	1	1
C10										-	0	0
C11											-	1
C12												-

Components linkage matrix

	S1	S2	S3	S4	S5	S6	S7	S8	S9	S10	S11	S12
S1	∞	1/2	1	1/2	1/2	1/2	1/2	1/2	1/2	1/2	1/2	1/2
S2		∞	1	1/2	1/2	1/2	1/2	1/2	1/2	1/2	1/2	1/2
S3			∞	1	1/2	1/2	0	1/2	1/2	1/2	1/2	1/2
S4				∞	1/2	1/2	0	1/2	1/2	1/2	1/2	1/2
S5					∞	1/2	0	1/2	1/2	1/2	1/2	1/2
S6						∞	1/2	1/2	1/2	1/2	1/2	1/2
S7							∞	0	1/2	1/2	1/2	1/2
S8								∞	1/2	1/2	1/2	1/2
S9									∞	1/2	1/2	1/2
S10										∞	1/2	1/2
S11											∞	1/2
S12												∞

Adjusted supplier dependency strength matrix

Table 7: Components linkage matrix & adjusted supplier dependency strength matrix comparing

Category 1: not linked components Flywheel/Connecting rod and not dependent partners S6/S4. In this case no specific treatment is required during the design phase neither on the components interface, nor in suppliers relations.

Suppliers S5/S7 with negligible dependency and supplying linked components Cylinder head cover/ Cylinder head block belong to category 2. In order to avoid potential dysfunctions, the focal company has to consider early and as soon as possible the realization aspects of both suppliers.

Category 3 is showed through the example of not linked components Piston/Timing belt and dependent suppliers S3/S9. This case requires defining explicit design rules for each partner by taking in account each partner work specifics and ensuring operational compatibility. For Category 4, we evoke the example of linked components Timing belt/alternator and dependent suppliers S9/S11.

6 CONCLUSION & PERSPECTIVES

This paper highlights and reinforces the importance of partners' dependencies and especially hidden ones. They are absolutely important to identify as soon as possible. This area has been under-explored by academics thinking that only the dependency between components, partners directly linked are important. This paper explores the implication of setting up valuated arcs between junction points that induce a relative dependence between two adjacent nodes. This adjacency is then extended to the whole set of partners.

The major contribution of this research lies in developing a formal approach able for analyzing the network (gBOMO, works connection graph) and providing useful managerial insights through the Dependency strength matrix. This matrix outlines the level of dependency that exists between all the partners involved in the network. This approach has been applied in a specific product (engine). Interesting interpretations comes from obtaining results:

- 1) Even if the components are interfaced in a given product, suppliers are not necessarily closely dependent.
- 2) Even if the partners seem to be "far" from each other, they are not necessarily.

This idea is the main pitfalls to which many deciders are confronted to. It is judicious to oversee and anticipate the

potential impact of one unexpected influent partner at early stage. In future works, the analysis will be extended to design phases process using Design-gBOMO. This study enables to confirm that partners apparently not dependent can being really dependent in realization process (because of some inherent constraints of timing, assembling ...), so that their mutual dependency may be taken into account even when the product is designed with the participation of different actors.

7 REFERENCES

- [1] Beamon, B. M. (1998). Supply chain design and analysis: Models and methods. International Journal of Production Economics, 55,281–294.
- [2] Meixell M.J, Gargeya V.B, (2005). Global supply chain design: A literature review and critique, Transportation Research Part E 41, pp 531–550.
- [3] Chopra S, Meindl P. (2004). Supply Chain Management: Strategy, Planning, and Operations, 2nd Edition. Upper Saddle River, NJ: Pearson Prentice Hall, Inc. pp. 511-512
- [4] Alonso-ayuso, A, Escudero, L.F, Garin, A, Ortuno, M.T, Perez, G. (2003). An approach for strategic supply chain planning under uncertainty based on stochastic 0–1 programming, J. Global Optimization 26, 97–124.
- [5] Shen, Z.-J.M. (2006). A profit-maximizing supply chain network design model with demand choice flexibility, Operations Research Letters 34, 673 – 682
- [6] Nieto M.J, Santamaria L, (2006) Technological collaboration: Bridging the innovation gap between small and large firms, Working Paper 06-66, Business Economics Series 20.
- [7] GIRARD Ph., ROBIN V., 2006, Analysis of collaboration for project design management, Computers in Industry, Vol. 57/8-9, pp 817-826
- [8] Ulrich K.T, (1995). The role of product architecture in the manufacturing firm. Research Policy 24, 419–440.
- [9] Browning T.R, Eppinger S.D, 2002 Modeling

- Impacts of Process Architecture on Cost and Schedule Risk in Product Development IEEE Transactions on Engineering Management, vol. 49, no. 4, pp. 428-442.
- [10] Fixson S. K. (2005) 'Product architecture assessment: a tool to link product, process, and supply chain design decisions', J. of Operations Management, Vol.23, No.3-4, pp 345-369
- [11] Shibata T, Yano M, Kodama F. (2005). Empirical analysis of evolution of product architecture Fanuc numerical controllers from 1962 to 1997, Research Policy (34), pp 13–31.
- [12] Otto & Wood, 2001 Incorporating Lifecycle Costs into Product Architecture Product Design. Prentice-Hall.
- [13] Dahmus J. B, Gonzalez-Zugasti J.P, Otto K.N. (2001). Modular product architecture, Design Studies, Vol.22, No.5, pp 409-424.
- [14] Ericsson, A. and Erixon, G. (1999). Controlling design variants : Modular product platforms, Society of Manufacturing Engineers and American Society of Mechanical Engineers, Fairfield, N.J.
- [15] Hölttä, K., Suh, E. S., & de Weck, Olivier. (2005) Trade-off between modularity and performance for engineered systems and products. In Proc of International Conference on Engineering Design, Melbourne August 15-18.
- [16] Sharman D. M, Yassine A. A. (2004). Characterizing Complex Product Architectures, Systems Engineering Journal, Vol.7, No.1, pp 35-60.
- [17] Clarkson P.J, Simons C, Eckert C. (2004) Predicting Change Propagation in Complex Design, JOURNAL OF MECHANICAL DESIGN, vol 126, pp 788-797.
- [18] Ullrich K., Eppinger S. (2003) 'Product design and development McGraw Hill.
- [19] Jiao J, Tseng M.M, Ma Q, Zou Y, (2000) 'Generic Bill-of-Materials-and-Operations for High-variety production management', CERA, 4(8), pp. 297-321.
- [20] Zolghadri M, Baron C, Girard P (2008). Modelling mutual dependencies between products architecture and network of partners, International Journal of Product Development, to be printed.
- [21] Zolghadri M., Bourrieres J.-P. (2006), 'Data aggregation mechanisms for production planning function of firms', Journal of decision systems, vol. 15, no. 4, pp. 425-452.