

Vortex Induced Aerodynamic Forces on a Flat Plate in Ground Proximity

Jenny Holt¹, Kevin Garry² and Renan Francisco Soares³

*Applied Aerodynamics Group, School of Aerospace, Transport and Manufacturing Cranfield University
BEDFORD. UK*

Vehicle underbody longitudinal vortices can have a significant effect on the aerodynamic loads experienced by a body in close ground proximity. A series of wind tunnel tests at a nominal Reynolds number of 2.26×10^6 , were carried out to investigate both (i) the influence of a moving ground plane simulation compared to fixed ground and (ii) the effect of relative location and strength of underbody longitudinal vortices on a simple flat plate, at zero incidence, fitted with vane vortex generators.

The presence of vortices between the plate and the ground plane serve to reduce the local pressure and generate a negative lift on the plate. The data indicate that an increase in vortex strength (proportional to an increase in vane vortex generator angle, β) increases plate negative-lift coefficient (C_L). The lift coefficient becomes more negative with decreasing ground clearance (h/c) for all cases except those for which there is evidence of vortex breakdown (high vane angles and low ground clearance). The variation of negative-lift-to-drag coefficient ratio shows that the overall aerodynamic efficiency is greater for smaller vortex generator angles at the lowest ground clearances. The pitching moment coefficient was found to change from nose down to nose up as ground proximity reduced indicating a movement in the centre of pressure position towards the plate trailing edge.

AR	= Aspect ratio (d/H)
β	= Vortex generator angle (deg)
C_L	= Lift coefficient
C_D	= Drag coefficient
C_m	= Pitching moment coefficient (+ve nose down, reference 30% chord)
c	= Chord (plate length 1m)
d	= Vortex generator spacing (mm)
D	= Drag (N)
L	= Lift (N)
H	= Height of vortex generator (25mm)
h	= vertical distance between plate and ground (m)
I	= Turbulence Intensity
L/D	= Lift to Drag Ratio
μ	= Viscosity (kg/ms)
μ_t	= Turbulent viscosity (kg/ms)
y	= Lateral distance from plate centre line (m)

¹ Lecturer in Aerodynamics, SATM, Cranfield University UK, MAIAA

² Professor of Experimental Aerodynamics, SATM, Cranfield University UK, MAIAA

³ PhD Researcher, SATM, Cranfield University UK

I. Introduction

The use of longitudinal vortices to generate and enhance aerodynamic lift has been applied to many configurations including; delta wings, dog-tooth wing leading edges and leading-edge-root-extensions. The application has also been valuable in automotive applications to enhance the performance of inverted aerofoils in ground effect and underbody diffusers, see for example Kuya et al [1]. This type of application has raised challenges in terms of the accuracy of computational simulations when used to aid prediction of vortex trajectory and strength. In order to support fundamental understanding an experimental study by Garcia et al. [2] and a numerical simulation by Knight [2] have investigated the characteristics of vortex generated forces on simple flat plates in ground effect fitted with conventional vane vortex generators. This work demonstrated the effectiveness of such configurations in terms of aerodynamic lift (downforce) generation, but the experimental study was carried out over a fixed ground plane which may have a considerable impact on the flow characteristics at small ground clearances. Numerical studies by Ranzenbach et al [4] on a cambered aerofoil in ground effect showed an appreciable error with downforce increasing and drag in most cases reducing when the ground plane is stationary.

Ranzenbach found that lift increases with ground proximity until such a point when the ground and body boundary layers merge thus reducing the underbody flow velocity and giving a lift peak at some finite ground clearance.

Zerihan et al [5] concluded that the loss of lift on aerofoils below the “peak” height was due to the increasing adverse pressure gradient on the trailing edge of the aerofoil on the suction surface. Kuya [1] later found that using vortex generators on the suction surface allowed the flow to remain attached at closer ground proximity due to the high energy vortex flow so increasing the lift at lower ground clearances.

In the flat plate case the vortex generators act to create reduction in the pressure between the plate and the ground plane. Based on the work of Kuya[1] and Rae [6] counter rotating vortex generators were used by Garcia [2] with two vortex generators either side of a symmetry line at angles of 10, 20 and 30 degrees to the freestream direction. Garcia found the larger vortex generator angles produced stronger vortices and so increased lift coefficient at lower ground clearances. However, in the 20 and 30 degree cases Garcia states that vortex burst occurs closer to the trailing edge of the vortex generator at low ground clearance causing a peak lift coefficient. Whereas for the 10 degree case lift coefficient is seen to increase asymptotically within the range of ground clearance tested. A similar trend is observed in the drag coefficient data.

Garcia also investigates the effect of lateral spacing on the vortex generators normalised in terms of aspect ratio. The results presented show that both lift coefficient increased for all values of ground clearance tested.

II. Experimental Methodology

An experimental test programme was carried out in the Cranfield University Automotive Wind Tunnel. This is a closed return layout facility with a rectangular working section 2.4m wide and 1.8m high with a flow velocity in the working section in the range 5 to 45m/s and free stream turbulence intensity of 0.1% at the wind tunnel velocity tested of 35m/s. A moving ground plane with primary ram intake and secondary porous plate variable boundary layer suction is also fitted in the working section, Figure 1.

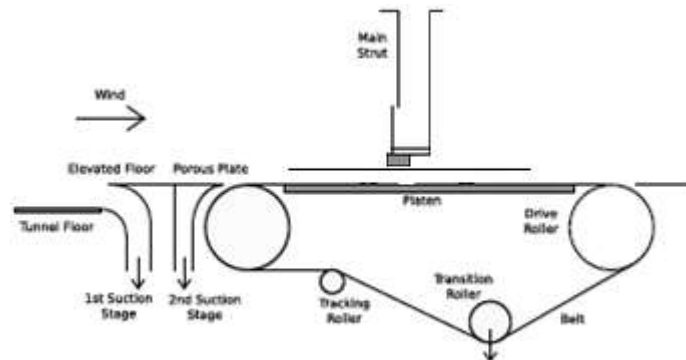

Figure 1 – Schematic arrangement of the moving ground plan, plate mounting strut and upstream boundary layer control system in the 2.4m x 1.8m working section

The wind tunnel model comprises of a flat plate, 1000mm long, 667mm wide and 12mm thick with 500mm leading and trailing edge planform radii each with a 6mm radius cross section profile, Figure 2. The planform reference area is taken to be 0.667m^2

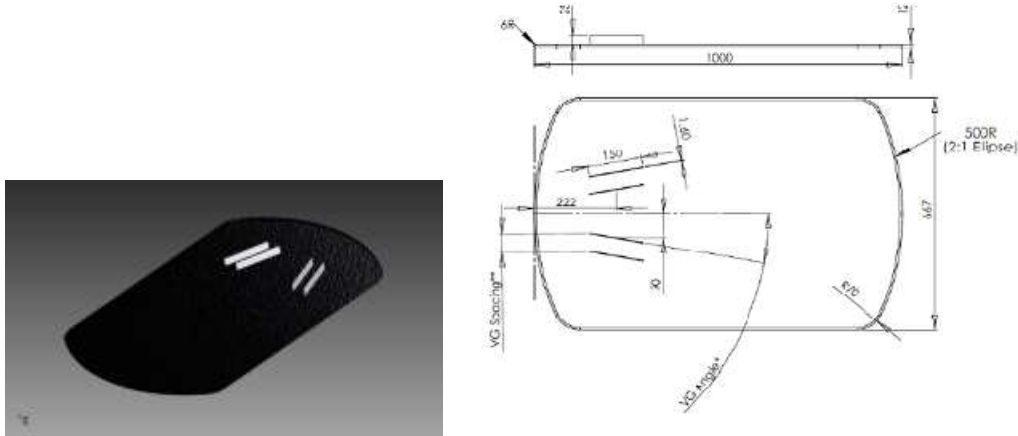

Figure 2 – Model geometry reproduced from Byrne [10] viewed from beneath plate

The vane vortex generators are aluminium flat plates, 1.6mm thick, 25mm high and 150mm long. Spacing and angle of each vane is achieved through two small location lugs at either end of the vane which locate into a series of pre-drilled holes in the flat plate. The vanes are mounted, orthogonal to the plate under-surface, at angles of 10, 15, 20 and 25 degrees to the free stream at a vane pair spacing of $AR=1$. The effect of variations in spacing between the individual vortex generator pairs, was also assessed at three spacings ($AR=0.5, 1$ and 2) for a fixed vane angle of 20 degrees.

The plate is mounted onto a six component Aerotech strain gauge balance at the bottom of a driven strut system which allows the ground clearance to be varied from $h/c=0.005$ to 0.1 , Figure 3.

The plate is transition free.

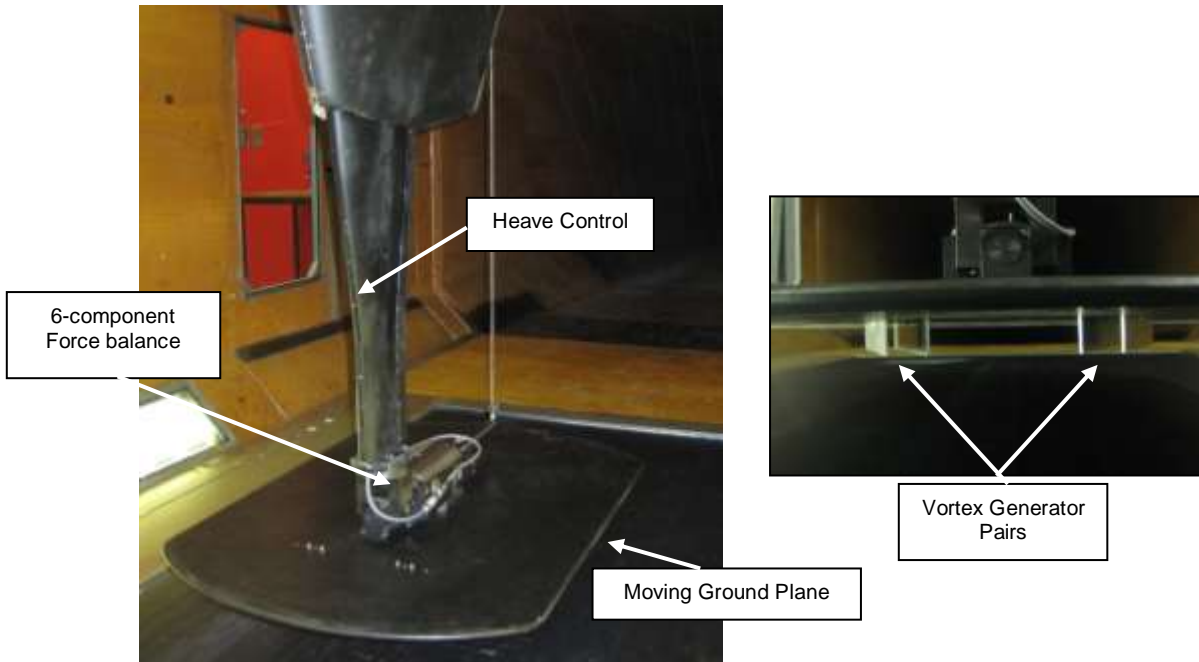

Figure 3 – Wind tunnel setup reproduced from Byrne [10]

A preliminary assessment of vortex trajectory at the plate trailing edge was also carried out for the AR=1 , vortex generator angle of 20 degrees case, using wool tufts, approximately 30mm in length, attached to a wire at a spacing of nominally 25mm, which was drawn across the wind tunnel working section at the mid-point between the plate and the ground plane.

III. CFD Methodology

A parallel RANS CFD study using Star CCM+ is used to determine whether a RANS simulation can predict this type of flow field with sufficient accuracy in order to interpret the flow field changes in the region between the flat and the ground plane.

The CFD setup parameters may be seen in Table 1 and boundary conditions in Table 2,

Feature	Properties
Body	Full-Scale 3D Model
Domain Simplification	Half-Symmetrical Domain
Ground Condition	Ground simulation (relative movement)
Simulation Approach	RANS
Freestream	35m/s
Time Regime	Steady-state
Flow Solver	Segregated
Equation of State	Constant Density
Flow Regime	Turbulent
Turbulence Model	Realizable k-ε two layer
Gradient Method	2 nd order hybrid Gauss LSQ
Number of Cells	~2x10 ⁶

Table 1 – CFD simulation parameters

Boundary	Condition	Parameters
Inlet	Velocity Inlet	35m/s
Outlet	Pressure Outlet	I=0.1%, $\mu_t/\mu=20$
Symmetry	Symmetry	
Walls	Symmetry	
Model	Wall	No slip
Ground	Wall	No slip relative movement, $U_{\text{ground}}=U_{\text{freestream}}$

Table 2 – CFD Boundary Conditions

Assumptions:

Symmetrical flow characteristics

The balance and support strut are not replicated in the CFD simulation.

Simulations have been carried out for $h/c=0.005$ to 0.1 , $AR=0.5$, 1 and 2 and for the flat plate alone.

IV. Experimental Results

A. Effect of Vortex Generator Angle

The influence of vortex generator angle for $AR=1$ on lift coefficient variation with non-dimensional height is presented in figure 4, it should be noticed that the y-axis is presented as negative lift coefficient.

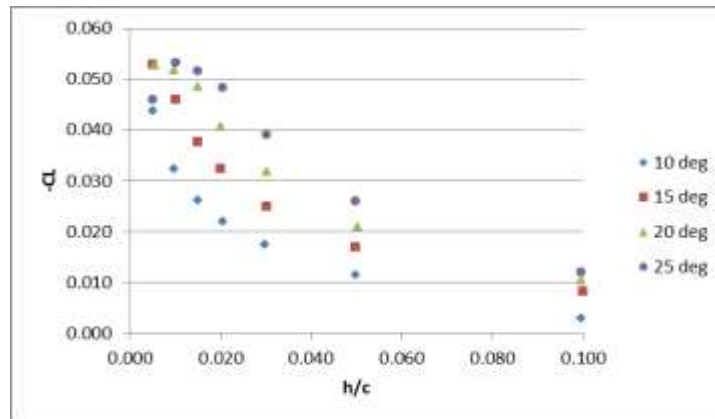

Figure 4 – Effect of VG angle on $-CL$ ($AR=1$)

Negative lift coefficient is seen to increase with decreasing ground clearance for all cases except a vane angle of 25 degrees. In this instance the lift coefficient drops sharply when $h/c < 0.01$. The 20 degree case is also seen to exhibit a significant decrease in rate of change of lift coefficient below this height and does not show notable improvement over the 15 degree case for the lowest ground clearance tested.

It is suggested that the increase in negative lift coefficient is a result of the plate at low ground clearance restricting the vertical movement of the vortex so it is unable to move away from the plate over a large portion of the plate length so increasing the suction effect. The decrease in negative lift for the 25 degree case may be a result of vortex breakdown. Zhang et al [7] reported a similar decrease in rate of change of CL with ground clearance. At the higher vortex generator angles it may be likely that vortex breakdown is occurring closer to the trailing edge of the vortex generator so reducing the suction.

Flow visualisation tests have show the vortex to be weaker below $h/c=0.01$ and not defined at all at $h/c=0.005$. Garcia [2] reported similar findings stating that the reduced ground clearance caused the vortices to “untwist” and breakdown for the higher vortex generator angles.

The drag coefficient, Figure 5 is seen to exhibit the same trends as seen in the lift coefficient. With drag increasing (albeit slowly above $h/c=0.05$) for all cases except 25 degrees at the lowest ground clearance tested. The lower drag for the 25 degree case at the lowest ground clearance is as a result of the loss of vortex induced lift.

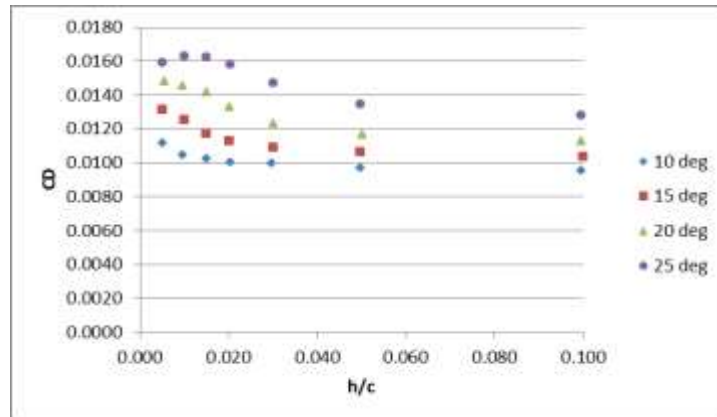

Figure 5 – Effect of changes in VG angle on C_D ($AR=1$)

Garcia saw a similar trend for 20 and 30 degree vortex generator cases fixed ground at the lowest ground clearances.

Study of the efficiency of the vortex generators assessed through analysis of the lift to drag ratio shows that careful consideration should be given to the ground proximity of the vortex generator when selecting suitable angles. Figure 6 shows the increased efficiency of the 15 degree vortex generator for the lowest ground clearances (15% increase in negative lift and 18% reduction in drag compared to 25 degree case) whereas the higher angles are more effective as ground proximity decreases.

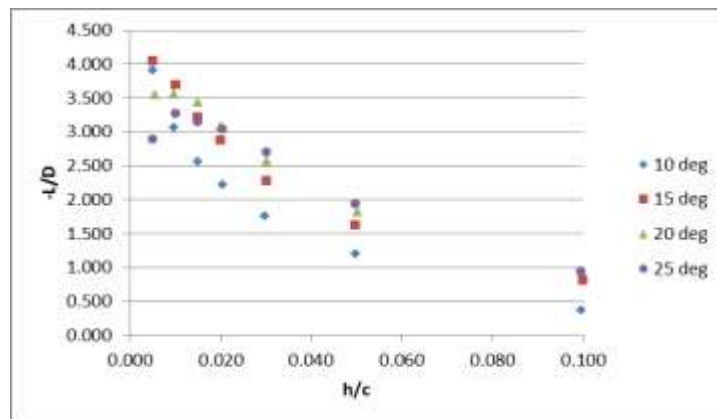

Figure 6 – Effect of changes in VG angle on $-L/D$ ($AR=1$)

Figure 7 present the pitching moment coefficient data for the configurations taken about a reference point of 30% plate length or 40mm of the vortex generator length. Positive pitching moment coefficient corresponds to a nose down pitching moment.

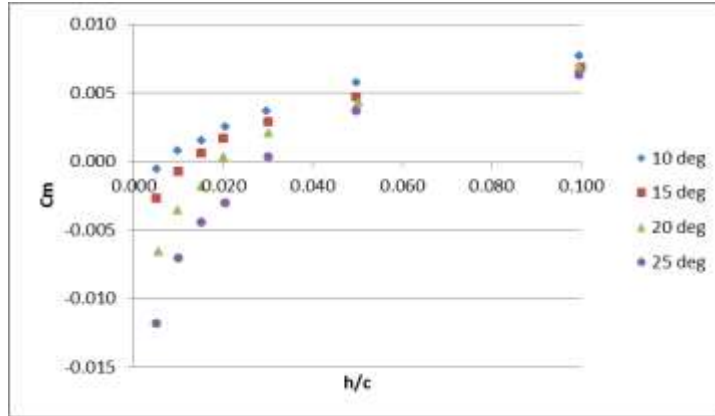

Figure 7 – Effect of changes in VG angle on C_m ($AR=1$)

Vortex generator angle is seen to have a significant influence on the sensitivity of the plate pitching moment coefficient (C_m) to ground clearance (h/c), see Figure 7. This is assumed to be due to the strong vortices produced at higher vortex generator angles acting to move the centre of pressure closer to the plate trailing edge.

The original tests by Garcia [2] were carried out over a fixed ground plane. Runs were also carried out in this test programme for vortex generator angle of 10 degrees and $AR=1$ with the moving belt held stationary.

Figure 8 and 9 present the change in negative lift coefficient and drag coefficient between the moving ground and fixed ground cases.

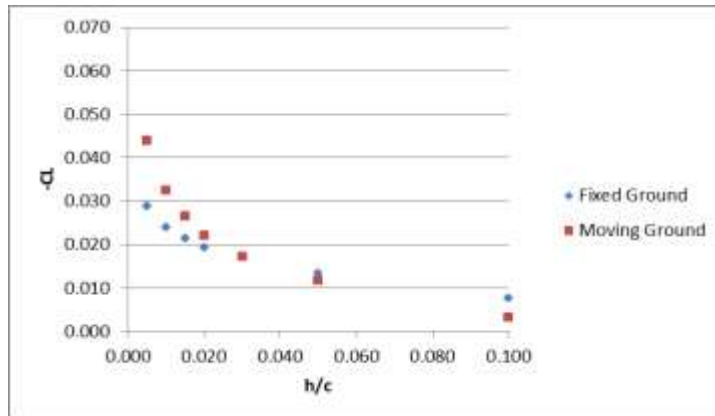

Figure 8 – Effect of moving ground simulation (fixed or moving) on plate negative lift coefficient ($-C_L$) for vane spacing ($AR=1$), and vane angle (β)=10 degrees.

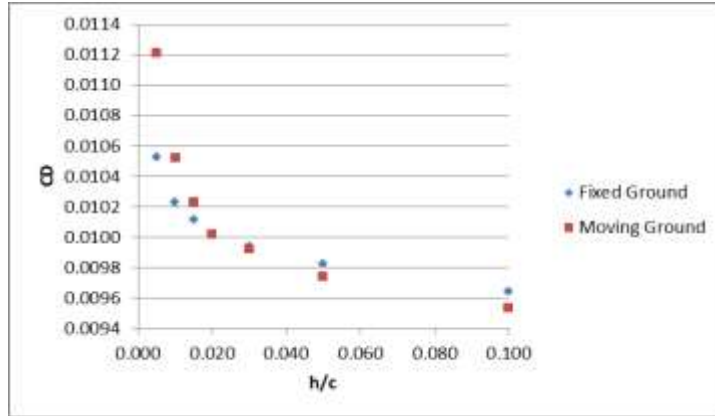

Figure 9 – Effect of moving ground on CD ($AR=1, \beta=10$)

At low ground clearances ($h/c < 0.03$) negative lift coefficient and drag coefficient are seen to be greater for the moving ground case, with the effect reversing above this height and a notable difference still being present at $h/c=0.1$. At the higher ground clearances, whilst the ground boundary layer is not directly interacting with the vortex generators, its presence is assumed to be reducing the effective ground clearance and hence increasing the flow velocity for the fixed ground case.

B. Effect of Vortex Generator Spacing

Data for cases where lateral spacing has been varied and vortex generator angle kept constant at 20 degrees have been non-dimensionalised as aspect ratio in this case spacing normalized by depth of vortex generator (25mm). Data are also presented for the plate alone with no vortex generators and for cases with the outer vortex generator from each pair removed to represent an “infinite” spacing case.

Negative lift coefficient data are presented in Figure 10.

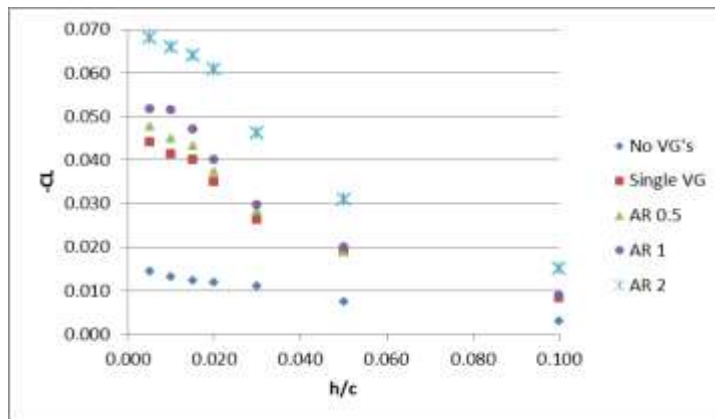

Figure 10 – Effect of VG Spacing on $-CL$ ($\beta=20$)

It is general thought based on the work by Rossow [8] that two “fences” are required for the production of a stable vortex. However, the single vortex generator case is seen to produce a negative lift coefficient of similar magnitude to the smaller spaced pairs ($AR=0.5$ and 1) for all but the lowest ground clearances.

The negative lift coefficient is greater across the range of ground clearances tested for the $AR=2$ case with a constant increment of lift between $AR=1$ and $AR=2$ for ground clearances below $h/c=0.05$.

The curve for $AR=1$ is seen to flatten between $0.005 < h/c < 0.01$ where a limit may have been reached. The vortices will co-rotate and it is possible that at some spacings and ground clearance the effect of one will be to damp the other so reducing vortex strength. This will be dependent on spacing and vortex radius.

The plate only is generating some negative lift at the highest ground clearance, as can be seen in Figure 3 the plate is mounted to a force balance and strut on the upper surface. These will act as a blockage and so induce an effective camber which will influence the lift produced. It is highly possible that at this ground clearance the plate is not free of the ground effect influence which will also contribute to the lift force.

The variation of plate drag coefficient (C_D) with ground clearance (h/c), for different vortex generator aspect ratios is shown in Figure 11. The general trend is seen to be similar to that for lift coefficient for the single vortex generator and both $AR=0.5$ and 1 .

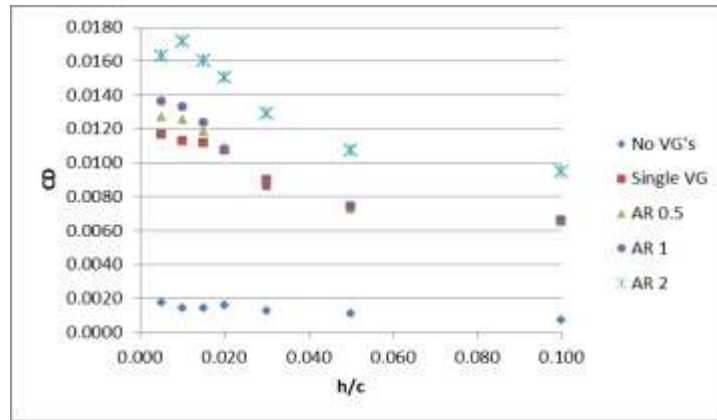

Figure 11 – Effect of VG Spacing on C_D ($\beta=20$)

However, for $AR=2$ a decrease in drag coefficient is seen for $h/c=0.005$ despite the increasing negative lift, see Figure 10. Pearcey [9] suggests that the interaction between the high energy flow in the vortex and the low energy flow in the boundary layer may reduce the boundary layer thickness, it is possible that the stronger vortex produced in the $AR=2$ case is sufficient to have this affect in this case.

The drag coefficient for the plate alone is seen vary very little in comparison to the vortex generator on cases as would be expected with the absence of vortex induced lift.

Pitching moment coefficient, Figure 12, is again seen to vary from nose down to nose up with increasing ground proximity (positive pitching moment is taken as nose down). For these constant angle cases, vortex generator spacing is seen to have limited effect on the pitching moment particularly for the closest ground proximities with the variation at $h/c=0.005$ being as little as 5%. The plate alone gives a nose down pitching moment which is likely to be as a result of the effective camber caused by the balance and support strut on the upper surface of the plate.

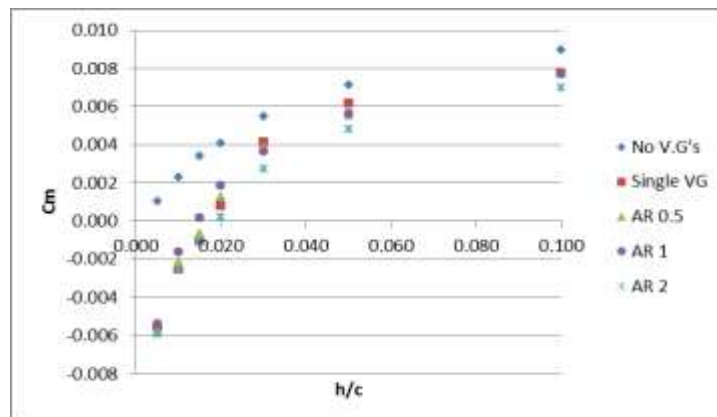

Figure 12 – Effect of VG Spacing on C_m ($\beta=20$)

C. Comparison with Previous Work

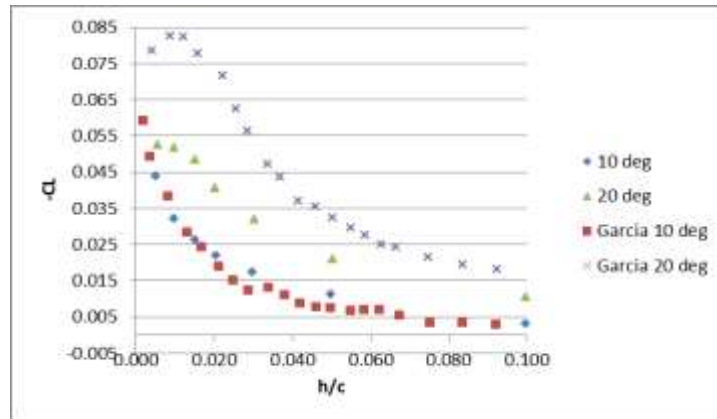

Figure 13 – Effect of VG Spacing on $-CL$ ($\beta=20$), Comparison with Garcia [2]

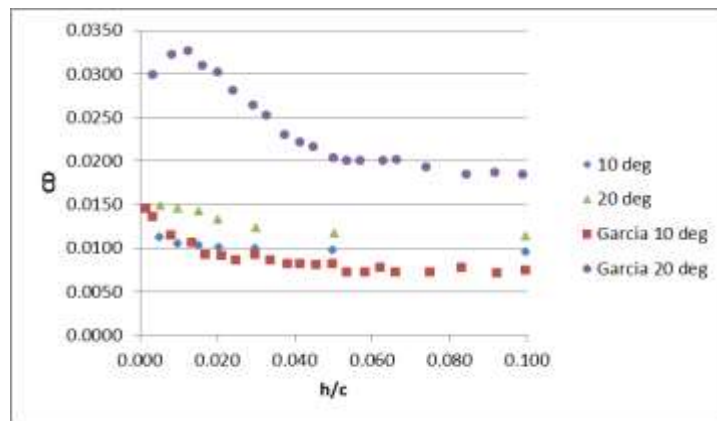

Figure 14– Effect of VG Spacing on CD ($\beta=20$), Comparison with Garcia [2]

Figures 13 and 14 compare the 10 and 20 degree vortex generator case ($AR=1$) for the fixed ground Garcia test and the present data. The 10 degree data are found to be in relatively close agreement which is not expected given the difference between fixed and moving ground whereas the 20 degree data are significantly different with the fixed ground plane giving a far higher negative lift. There are two possible explanations, the interaction with the boundary layer growth mentioned earlier will be highly Reynolds number sensitive. The present data are acquired at a Reynolds number of 2.26×10^6 , whereas the Garcia data is acquired at 2.7×10^6 . The plate used by Garcia is square edged (see figure 21) and so will form vortices from the sharp edges of the plate leading to greater gains in induced lift.

V. CFD Results

A. Effect of Vortex Generator Spacing

A parallel CFD study was undertaken using a RANS simulation in StarCCM+, setup is presented in section III.

Results showed that whilst the CFD study was able to produce similar trends to the experimental data absolute magnitude were not well predicted. Figure 15 shows the incremental negative lift coefficient relative to the plate only for the three aspect ratios testing at a fixed vortex generator angle of 20 degrees

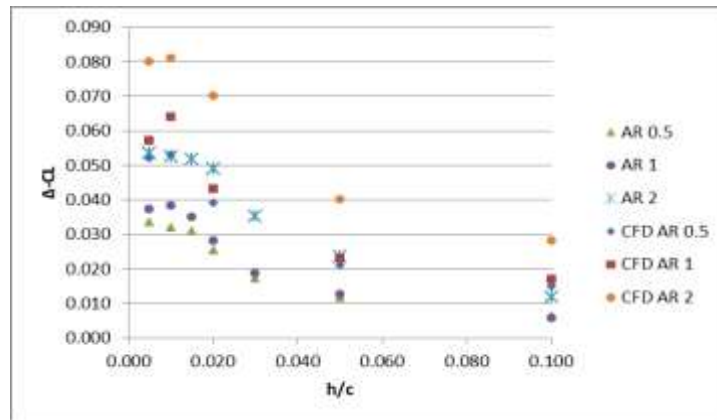

Figure 15 – Effect of VG Spacing on increment of negative lift coefficient from plate only ($\Delta-CL$) ($\beta=20$), Comparison with CFD

CFD data represent the rapid reduction in rate of change of negative lift coefficient between $h/c=0.005$ and 0.01 but implies the loss of negative lift to be more significant for the $AR=1$ case than for $AR=0.5$ and 2 which is not seen in the experimental data. The reason for this is not clear.

B. Vortex Trajectory

Comparison between predicted lateral vortex core position at the trailing edge of the plate is presented in Figure 16. The experimental data is taken from tuft flow visualisation on a fixed grid and so is subject to error in position prediction.

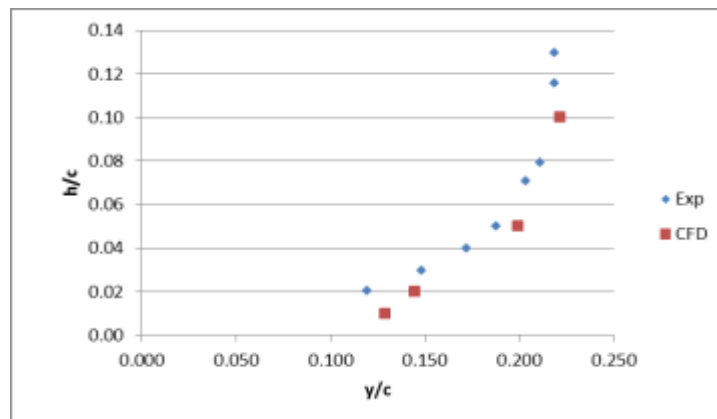

Figure 15 – Vortex Trajectory ($\beta=20$, $AR=1$), Comparison with CFD

Correlation at the higher ground clearances is reasonable, decreasing as ground clearance decreases. The experimental methodology made position detection at these low ground clearances challenging as the vortices became less distinct. Both CFD and experiment predict the motion of the vortex is towards the centre of the plate as ground clearance is reduced.

Figure 17 to 19 highlight the volution of the vortex for $h/c=0.005$, 0.02 and 0.1 respectively.

At ground clearances below $h/c=0.02$ the vortex appears to lose definition and spreads over a larger area but at $h/c=0.02$ two distinct co-rotating structures are visible. At $h/c=0.05$ and 0.01 we observe one large stable structure.

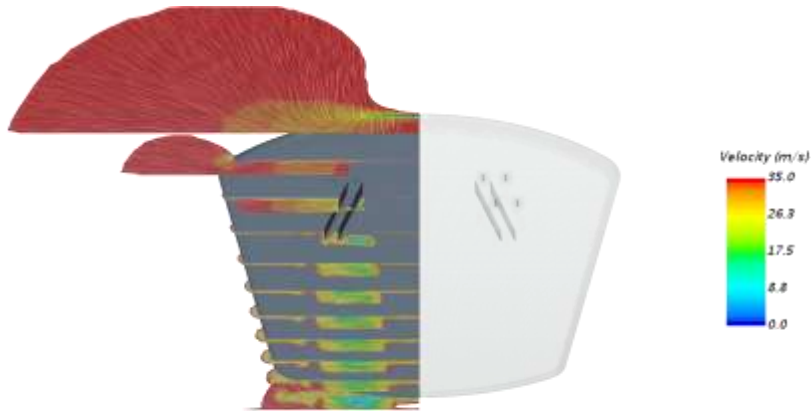

Figure 17 – CFD velocity contours $h/c=0.005$ ($AR=1$, $\beta=20$)

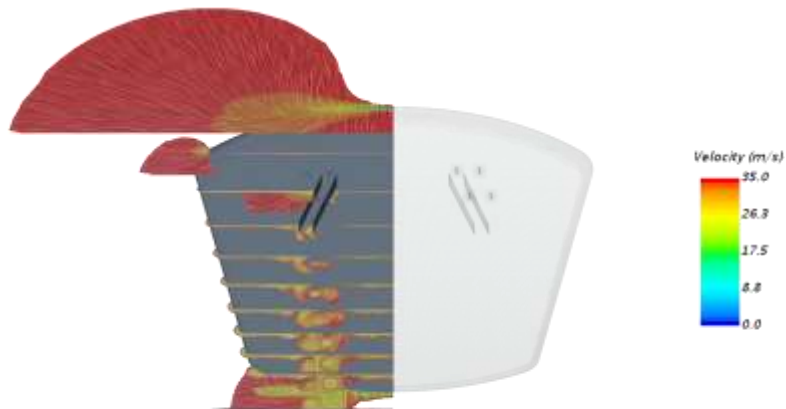

Figure 18 – CFD velocity contours $h/c=0.02$ ($AR=1$, $\beta=20$)

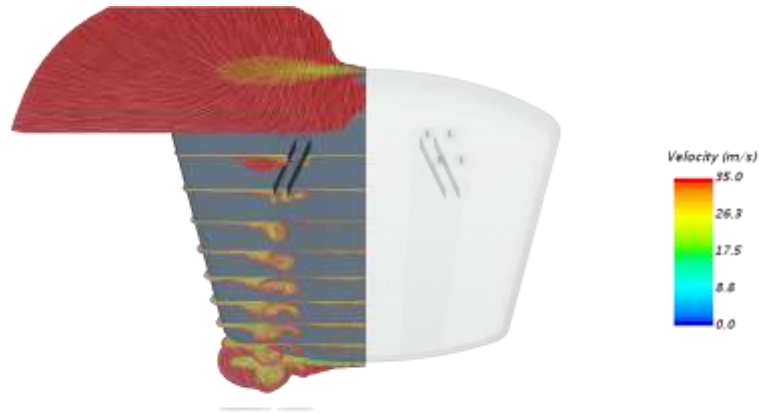

Figure 19 – CFD velocity contours $h/c=0.2(AR=1, \beta=20)$

VI.

VII. Conclusion

The induced negative lift coefficient on the plate is found to increase with increasing vortex generator angle and reduced ground clearance when spacing is held constant at $AR=1$. This is true for all cases except 25 degrees and $h/c=0.005$ where it is thought that vortex breakdown occurs close to the plate trailing edge. During the experiments the plate was seen to vibrate significantly at the trailing edge for this condition supporting this theory. For $0.05 < h/c < 0.1$ the change in drag coefficient is very small but increases as h/c is reduced below 0.03. Analysis of the lift to drag ratio suggests that for this spacing higher vortex generator angles are not always advantageous and thought should be given to ground proximity. For $h/c=0.1$ a vortex generator angle of 25 degrees yields the greatest lift to drag ratio whereas at $h/c=0.005$ a vortex generator angle of 15 degrees is the most efficient. At larger ground clearance pitching moment coefficient is positive (nose down) for all cases, however, at some ground clearance the centre of pressure moves downstream of the 30% plate length reference position and the pitching moment becomes negative. The point at which this changeover occurs varies with vortex generator angle, occurring at increasing larger distances from the ground plane as vortex generator angle is increased. It is suggested that this occurs because the larger angles produce stronger vortices with larger radii that become trapped at higher ground clearances and so create a suction effect on the rear of the plate.

Data for vortex generator spacing equal to aspect ratios of 0.5 (12.5mm), 1 (25mm) and 2 (50mm) at a fixed vortex generator angle of 20 degrees have been presented. Also studied were the flat plate alone and a single vortex generator. It was found that the single vortex generator produced negative lift coefficients and drag coefficients similar in magnitude to the $AR=0.5$ and 1 cases when the ground clearance was equal or greater than $h/c=0.03$.

When $AR=2$ a significant increase in lift and drag coefficient occurs. CL_{max} increases across the aspect ratios tested and indeed a separate work by Bray [11] states that this would be the case up to $AR=6$. Application will dictate whether such a high aspect ratio is useful as this represents a vortex generator spacing of 150mm.

For $AR=0.5$ and 1 there is little change in pitching moment coefficient indicating that vortex generator angle is more significant than spacing.

Comparison to fixed ground data from Garcia [2] shows generally trends are well reproduced but absolute values are not. The exact cause is not clear although Reynolds number is slightly mismatched and the Garcia plate has sharp corners and edges so may be producing vortices that are enhancing the lift. No data for plate alone is given by Garcia for comparison.

The CFD simulation is able to produce the general trends seen in the experimental data for the effect of vortex spacing but is not able to well predict absolute magnitudes of negative lift coefficient.

Vortex trajectory at the trailing edge is in reasonable agreement between CFD and experimental data for all but low ground clearances. The experimental technique in this region was found to be insufficient so positions presented have a high level of uncertainty.

Acknowledgments

The authors wish to recognize the contributions made by two Aerospace Dynamics Masters candidates at Cranfield University whose work contributed to both the development of the test technique and the current data set, namely: Daniel Byrne and Sonia Hegde.

References

- ¹ Kuya, Y. Takeda, K. and Zhang, X. Flow Separation Control on a Race Car Wing with Vortex Generators in Ground Effect. Southampton: Journal of Fluids Engineering. 2009. Vol. 131
- ² Garcia D.L and Katz J. Trapped vortex in Ground effect. Reston: American Institute of Aeronautics and Astronautics (AIAA), 2002. Vol. 41, 4
- ³ Knight, K. CFD Investigation into the Creation and Distortion of Vortices. MSc Thesis Cranfield University UK, 2003.
- ⁴ Ranzenbach, R. and Barlow, J. Cambered Airfoil in Ground Effect – Wind Tunnel and Road Conditions. S.I: American Institute of Aeronautics and Astronautics (AIAA), 1995. AIAA-95-1909-CP
- ⁵ Zerihan, J and Zhang, X. Aerodynamics of a Single Element Wing in Ground Effect. Reston: American Institute of Aeronautics and Astronautics (AIAA), 2000. Vol 37, 6
- ⁶ Rae, A.J. Investigation into the Scale Effects on the Performance of Sub-Boundary Layer Vortex Generators on Civil Aircraft. American Institute of Aeronautics and Astronautics (AIAA), 2002. AIAA-2002-3274
- ⁷ Zhang, X. Toet, W and Zerihan, J. Ground Effect Aerodynamics of Race Cars: Applied Mechanics Reviews, 2006. Vol 59, 1. AA118195
- ⁸ Rossow, V.J. Aerodynamics of Airfoils with Vortex Trapped by Two Spanwise Fences : Jn. of Aircraft, Vol. 31, 1 (1994)
- ⁹ Pearcey, H.H. Shock Induced Separation and its Prevention by Design and Boundary Layer Control. Boundary Layer Flow Control, Its Principles and Applications, Volume 2. Oxford Pergamon Press. 1961
- ¹⁰ Byrne D. Vortex Induced Aerodynamic Forces in Ground Effect, MSc Thesis Cranfield University UK, 2010
- ¹¹ Bray, T.P. A Low-Speed Parametric Study of Vane and Air Jet Vortex Generators Set in a Turbulent Flat Plate Boundary Layer. Cranfield College of Aeronautics. Cranfield University 1997

Vortex induced aerodynamic forces on a flat plate in ground proximity

Holt, Jennifer C.

2016-12-31

Attribution-NonCommercial 4.0 International

Holt JC, Garry KP. Vortex induced aerodynamic forces on a flat plate in ground proximity. In: 34th AIAA Applied Aerodynamics Conference, 13-17 June 2016, Washington, D.C., USA

<https://doi.org/10.2514/6.2016-4170>

Downloaded from CERES Research Repository, Cranfield University