

Aircraft thermal management: practices, technology, system architectures, future challenges, and opportunities

Van Heerden, A.S.J.¹, Judt, D.M.², Jafari, S.³, Lawson, C.P.⁴, Nikolaidis, T.⁵,
Cranfield University, College Rd, Cranfield, Wharley End, Bedford MK43 0AL, United Kingdom

and

Bosak, D.⁶

Meggitt PLC, Pilot Way, Ansty Business Park, Coventry CV7 9JU, United Kingdom

Abstract

The provision of adequate thermal management is becoming increasingly challenging on both military and civil aircraft. This is due to significant growth in the magnitude of onboard heat loads, but also because of their changing nature, such as the presence of more low-grade, high heat flux heat sources and the inability of some waste heat to be expelled as part of engine exhaust gases. The increase in the use of composites presents a further issue to address, as these materials are not as effective as metallic materials in transferring waste heat from the aircraft to the surrounding atmosphere. These thermal management challenges are so severe that they are becoming one of the major impediments to improving aircraft performance and efficiency. In this review, these challenges are expounded upon, along with possible solutions and opportunities from the literature. After introducing relevant factors from the ambient environment, the discussion of the challenges and opportunities is guided by a simple classification of the elements involved in thermal management systems. These elements comprise heat sources, heat acquisition mechanisms, thermal transport systems, heat rejection to sinks, and energy conversion and storage. Heat sources include both those from propulsion and airframe systems. Heat acquisition mechanisms are the means by which thermal energy is acquired from the sources. Thermal transport systems comprise cooling loops and thermodynamic cycles, along with their associated components and fluids, which move the heat from the source to the sinks over potentially large distances. The terminal aircraft heat sinks include atmospheric air, fuel, and the aircraft structure. In addition to the discussions on these different elements of thermal management systems, several topics of particular priority in aircraft thermal management research are deliberated upon in detail. These are thermal management for electrified propulsion aircraft, ultra-high bypass ratio geared turbofans, and high power airborne military systems; environmental control systems; power and thermal management systems; thermal management on supersonic transport aircraft; and novel modelling and simulation processes and tools for thermal management.

¹ Corresponding author: a.s.van-heerden@cranfield.ac.uk; Research Fellow, Centre for Propulsion Engineering

² Lecturer, Centre for Aeronautics

³ Lecturer, Centre for Propulsion Engineering

⁴ Senior Lecturer, Centre for Aeronautics

⁵ Reader, Centre for Propulsion Engineering

⁶ Principal Engineer

Nomenclature

Symbols

A	Area	m^2
C_p	Heat capacity	J/kgK
E	Open circuit voltage	V
h	Heat transfer coefficient	W/m^2K
I	Electrical current	A
M	Mach number	-
m	Mass	kg
\dot{Q}	Heat transfer rate	W
T	Temperature	K
t	Time	s
τ	Time constant	
Pr	Prandtl number	-
R	Thermal resistance	K/W
ρ	Density	kg/m^3
V	Voltage	V
V	Volume	m^3
x, y, z	Spatial coordinates	
k	Thermal Conductivity	W/mK

Abbreviations

ACM	Air-Cycle Machine
ACOC	Air-Cooled Oil Cooler (see also 'AOHE')
AGB	Accessory Gearbox
AOHE	Air-Oil Heat Exchanger (also called Air-Cooled Oil Cooler, or 'ACOC')
APU	Auxiliary Power Unit
ATI	Aerospace Technology Institute (United Kingdom)
BHAS	Battery Heat Acquisition System
BPR	Bypass Ratio
CC	Combustion Chamber
CFD	Computational Fluid Dynamics
CFRP	Carbon Fibre Reinforced Polymer
CS	Certification Specifications (European Aviation Safety Agency)
DEW	Directed Energy Weapon
EASA	European Aviation Safety Agency
ECS	Environmental Control System
EDM	Electrical Discharge Machining
E/E	Electrical Equipment
EHA	Electrohydrostatic Actuator
EIS	Entry-Into-Service
EMA	Electromechanical Actuator
EPA	Electrified Propulsion Aircraft
EPS	Electrical Power System
eVTOL	Electric Vertical Take-off and Landing
FAA	Federal Aviation Agency
FADEC	Full Authority Digital Engine Control
FCOC	Fuel-Cooled Oil Cooler (see also 'FOHE')
FCS	Flight Control System
FOHE	Fuel-Oil Heat Exchanger (also called Fuel-Cooled Oil Cooler, or 'FCOC')
FTMS	Fuel Thermal Management System
GTF	Geared Turbofan
HEW	High Energy Weapon
HPC	High Pressure Compressor
HPS	Hydraulic Power System
HPT	High Pressure Turbine
HX or HE	Heat Exchanger
IDG	Integrated Drive Generator
IMD	Integrated Motor Drive
IPS	Ice Protection System
ISA	International Standard Atmosphere
JP	Jet Propellant (used in the naming for several military jet fuels)
KBE	Knowledge-Based Engineering
LFL	Lower Flammability Limit
LHP	Loop Heat Pipe
LIGA	Lithographie Galvanoformung Abformung (manufacturing process)
LNG	Liquefied Natural Gas

LPC	Low Pressure Compressor
LPT	Low Pressure Turbine
LRSA	Long-Range Strike Aircraft
MEM	Microelectromechanical
MIL-HNDB	Military Handbook (specification)
MIL-PRF	Military Performance (specification)
MTOW	Maximum Take-Off Weight
NACA	National Advisory Committee for Aeronautics
NASA	National Aeronautics and Space Administration
NPSS	Numerical Propulsion System Simulation
NTU	Number of Transfer Units
OAT	Outside Air Temperature
PAO	Polyalphaolefin
PCM	Phase Change Material
PGB	Power Gearbox
PTMS	Power and Thermal Management System
SE	Systems Engineering
SFC	Specific Fuel Consumption
SST	Supersonic Transport
TET	Turbine Entry Temperature
TMS	Thermal Management System
TRL	Technology Readiness Level
UAV	Unmanned Aerial Vehicle
UFL	Upper Flammability Limit
UHBR	Ultra-High Bypass Ratio
VCC/VCS	Vapour Compression Cycle/System
VCTB	Vapour Compression Thermal Bus
VFG	Variable Frequency Generator
VTOL	Vertical Take-off and Landing

1. Introduction

Providing a means to manage adequately the growing thermal waste energy on board modern aircraft is becoming increasingly challenging. This problem of thermal management used to be confined to aircraft undergoing excessive aerodynamic heating while traveling at high Mach numbers, but, because of a general increase in the magnitude and number of internal heat loads, it is progressively also affecting the design of aircraft in the subsonic domain. Future aircraft are expected to require cooling at the level of megawatts rather than the kilowatts required by current aircraft [1].

The problem is particularly acute in the case of military aircraft. In fact, the mission capabilities and endurance of some advanced combat aircraft are now being restricted by thermal limitations, rather than fuel capacity [2]–[8]. This issue has arisen because of substantial increases over the past few decades in the power consumption and associated heat losses (Figure 1) of on board components and systems, such as, avionics, electromechanical flight control actuators, engine accessories, and weapon and mission systems [2]. Simultaneously, the growing use of composite materials in airframe structures has resulted in diminishing opportunities for transporting excess waste heat away from the aircraft to the atmosphere. This is because the thermal conductivities of these materials are usually lower than metallic materials, which leads to lower conduction of heat through the airframe structure. In some cases, structural cooling is also required to lower the infrared signature of the aircraft to maximise its survivability. This further increases the heat load to be managed [9].

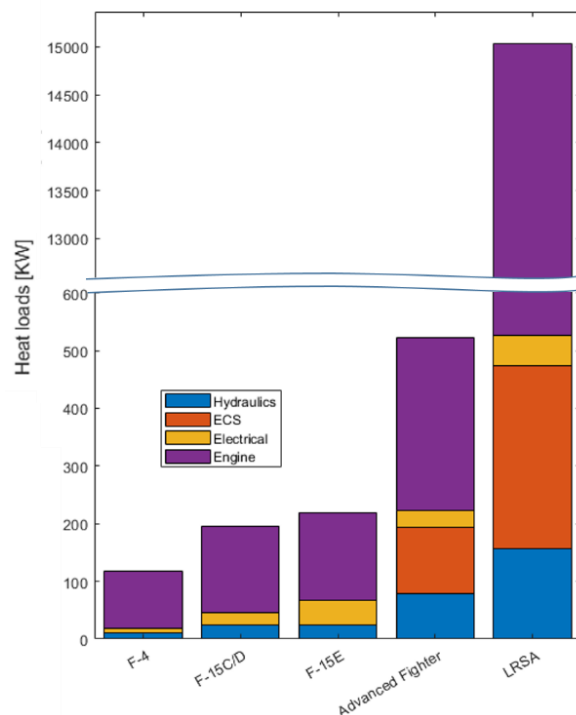

Figure 1: The increase in heat loads on board tactical aircraft (adapted from [10]). Note: ECS = Environmental Control System; LRSA = Long-Range Strike Aircraft.

This intensification of heat sources on military aircraft has led to an increase in the reliance on fuel as a heat sink. However, using fuel for this purpose can cause fuel temperatures to rise above allowable operability limits during a mission [2]. When these limits are breached, the maximum ‘thermal endurance’ of the aircraft is said to be reached. This implies that overall mission endurance is cut short, despite fuel still being available for propulsion. These problems are expected to

become more severe with the forthcoming introduction of new technologies, such as directed energy weapons [10]–[13].

For civil transport aircraft, the increase of electrically powered subsystems, the imminent implementation of ultra-high bypass geared turbofan engines, as well as the possible advent of electrified propulsion, are also expected to bring forth significant increases in on board waste heat loads [14]–[18]. As with military aircraft, this increase in heat loads also coincides with a growing use of composite materials for airframe structures and subsequent diminished heat sink capacity. The addition of new means to handle adequately these heat loads could erode the energy savings that these technologies could enable, either because of increases in engine power offtakes or the introduction of additional drag or mass. It is therefore paramount that novel thermal management systems be designed with care and that innovative solutions are pursued.

Considering these challenges, a review of aircraft thermal management is due. Such a review would support the design and development of future thermal management systems. Pursuant to this, the authors undertook a comprehensive review of current practices, technologies, systems architectures, and future challenges regarding aircraft thermal management. The purposes of this review were as follows:

- to provide a collated overview of current and potential future thermal management system implementations in modern military and civil transport aircraft (including certification considerations).
- to provide a critical analysis of the recent academic literature related to aircraft thermal management.
- to identify and articulate challenges and opportunities for future research and development in aircraft thermal management.

In performing the review, the definition employed for ‘aircraft thermal management’ was the following:

Aircraft thermal management is the means by which an on-board thermal environment is established that (i) ensures safe and efficient operation of the aircraft and its on-board systems and (ii) meets the thermal requirements of the payload.

The ‘means’ in this definition can refer to the heat transfer processes of convection, conduction, and radiation, but also to the physical components (or sets thereof) that perform this transport function. However, the focus of this review was primarily on thermal management ‘systems’, i.e., multiple components, potentially located across several different physical zones in the aircraft, operating in unison to perform thermal management. This is opposed to ‘local’, ‘federalised’, or ‘component’ thermal management, such as performed by finned heat sinks on electronic components. The reasons for limiting the scope in this manner were as follows:

- Local or component thermal management is covered well in other reviews for a wide variety of potential aerospace heat sources and thermal transport devices. Conversely, there is a paucity in the literature of collated, comprehensive information on the practices, challenges, and advances in systems approaches to aircraft thermal management.
- It is increasingly being recognised that a systems approach, i.e., managing the transport of thermal energy across the whole aircraft and its subsystems, in an integrated manner, is necessary to address optimally the ever-growing on-board heat loads.
- It is also recognised that local means (in this case specifically referring to ‘passive’ options) are becoming inadequate for successful thermal management and dedicated

thermal management systems, spanning several different physical zones across the aircraft, are increasingly becoming necessary.

However, brief discussions on high-potential novel local heat sink or heat exchanger technologies that could constitute parts of a larger system are indeed provided where relevant.

The scope was further limited to include only thermal management on flying vehicles operating within the earth's atmosphere at sub- and supersonic velocities. Hypersonic vehicles were excluded, as the challenges regarding these are substantially different from sub- and supersonic aircraft and because there are already relevant recent reviews available (e.g. Ref. [19]).

The work in this article formed part of the preparatory literature investigation for a large-scale aircraft thermal management research project, called the 'Ultra High Bypass Ratio (UHBR) Thermals' programme. In this Innovate UK and Meggitt PLC funded program, novel engine and airframe heat exchange concepts for future UHBR geared turbofan aircraft engines were investigated and their benefits quantified at the system and aircraft level [20].

This introduction is followed in Section 2 by a description of the methodology employed to perform the review. Fundamental thermal management concepts are introduced in Section 3, which also provides a rationale for the organisation of the paper. In Section 4, a short description of the ambient environment is provided, as the operating environment has a significant influence on thermal management. The review itself begins in Section 5, with a discussion on heat sources, followed by heat sinks in Section 6, and a discussion on thermal transport means in Section 7. In Section 8, a number of topics of special relevance are covered. These are thermal management for electrified propulsion aircraft, ultra-high bypass ratio geared turbofans, and high power airborne military systems; environmental control systems; power and thermal management systems; thermal management on supersonic transport aircraft; and modelling and simulation processes and tools for thermal management. Finally, the work is concluded in Section 9, which also provides a summary of further research opportunities and challenges.

2. Methodology

To perform the review, the academic literature on aircraft thermal management was combed to find the most relevant information. The scientific database Scopus was employed for this purpose, with the main search words being 'aircraft thermal management' and 'aircraft thermal management systems.'

An analysis of the results for the keywords 'aircraft thermal management' provided by Scopus shows a sharp increase in research output related to aircraft thermal management over the past 20 years (Figure 2). This increase reflects the growing importance that is being attached to this topic. The documents for these keywords span almost six decades, with the majority (almost two thirds) being conference papers and the rest being journal articles (about a quarter of the documents) or reports. This abundance of conference papers was expected, as industry is heavily involved in the development of aircraft thermal management systems and tends to participate in conferences more than publishing in journals.

Other phrases used as keywords to conduct the review included different manifestations of the following (preceded with the word 'aircraft', 'aeronautical', and/or 'aerospace' where relevant): 'heat sources/sinks', 'engine/gas turbine heat soakage', 'avionics/power electronics cooling', 'electrified propulsion/hybrid electric cooling/thermal management', 'hydraulics cooling', 'actuator cooling', '(ram/fan) air cooling', 'skin/surface heat exchangers', 'fuel cooling/thermal

management/behaviour', 'fuel flammability', 'cooling fluids', 'heat exchangers', 'heat pipes', 'refrigeration cycles', 'directed energy weapons cooling', 'environmental control system', 'power and thermal management systems', 'geared turbofan cooling/thermal management', and 'thermal modelling'.

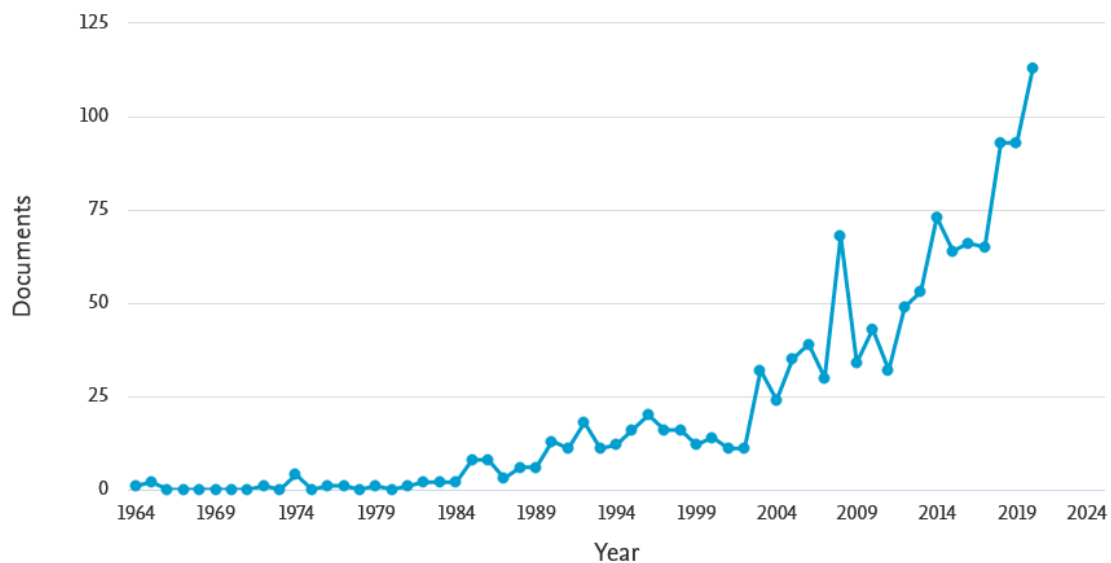

Figure 2: Number of documents published per year according to the results for a Scopus search using the keywords "aircraft thermal management".

For each set of keywords, the titles and subsequently abstracts of the results obtained were consulted to determine whether they are within the scope. This narrowed down the search, enabling the documents to be scrutinised for the following information (as relevant to the particular topic): fundamental working principles, heat sources/sinks identified along with their relevant parameters, thermal transport system employed/proposed, application/case study/use case (type of aircraft/mission, and so forth), novel aspects introduced, and pertinent challenges and opportunities articulated. These were then used to construct the narrative of the review.

3. Basic thermal management system concepts

It is often useful to approach discussing the broad topic of aircraft thermal management systems (TMS) by classifying the different constituent aspects of these systems into broadly similar elements. There are many ways to do this and the authors opted to devise a comprehensive classification, adapted from Pal and Severson [21], as shown in Figure 3.

As can be seen in Figure 3, there are five major elements related to aircraft thermal management systems: 'heat sources', 'heat acquisition' mechanisms, 'thermal transport' means, 'heat rejection' mechanisms, and 'heat sinks'.

The thermal management system (TMS) itself is limited to the heat acquisition, transport, rejection, and sink elements. However, the heat sources are fundamental to the discussion, as their behaviour affect the requirements of the thermal management system. Note that, similarly, the terminal sinks could also be considered as separate from the TMS, as they could be totally external to the system (i.e., the atmosphere) or being a heat sink may not be their primary function (i.e., fuel). However, as with the sources, it is essential that they be part of the discussion, because of their importance. Figure 4 shows the locations of the main heat sources and sinks covered in this review for hypothetical civil transport and tactical military aircraft.

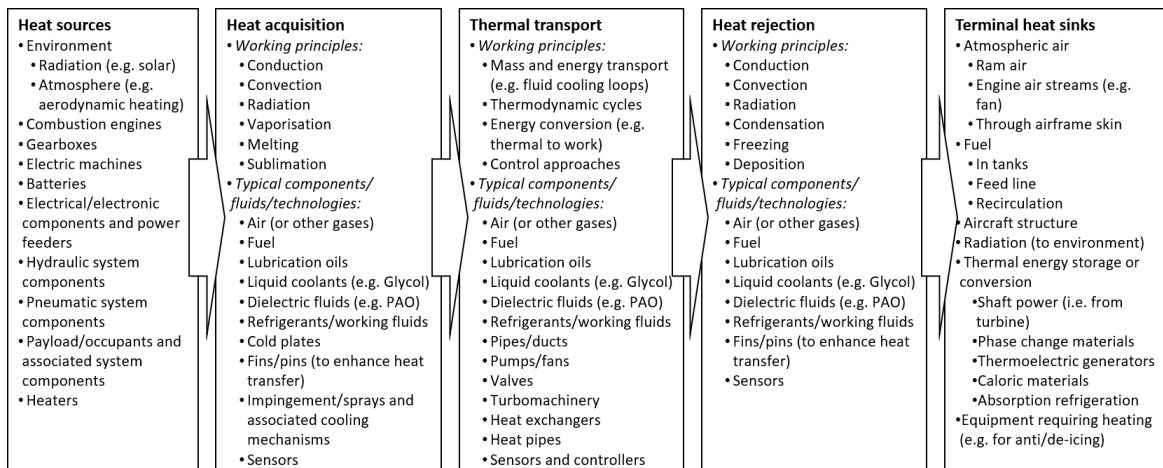

Figure 3: Elements of a generic aircraft thermal management system. The arrows indicate the flow of thermal energy (adapted extensively from Pal and Severson [21]).

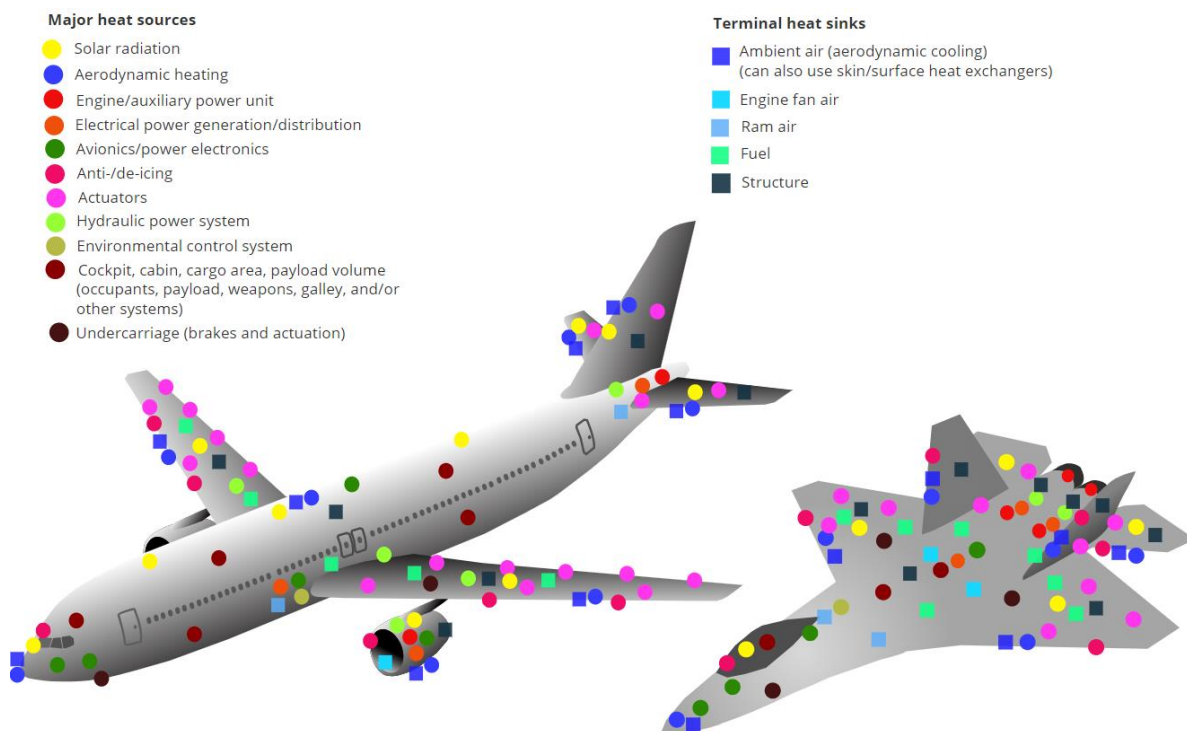

Figure 4: Locations of the main aircraft heat sources and sinks covered in this review.

The heat source is any component or system that produces heat – either as a by-product of performing its function (i.e., waste heat produced because of energy inefficiency), or as its main function (such as in the case of cabin heaters, or anti/de-icing systems). Heat sources are usually also present in the environment, such as the sun, radiation from the earth’s surface, or convective heating due to friction with atmospheric air (referred to as ‘aerodynamic heating’). If the heat produced by the source is undesirable, some sort of heat acquisition means is required. This refers to the mechanisms that enable heat transfer from the component to its immediate environment by means of the fundamental working principles of conduction, convection, radiation, as well as the latent heat mechanisms. The aim of heat acquisition is to remove the thermal energy from the source at a sufficient rate to maintain or lower its temperature. There are many well-understood techniques to do this. Some common examples include:

- Conduction (transfer of heat to another material in contact with the heat source).
- Convective air- or oil-cooling for propulsion or other power components.

- Electronics cooling with conduction to a conductive finned/or pinned structure attached to the component, combined with subsequent convection to air or some cooling fluid.
- The use of cold plates for electrical equipment. This involves conduction of heat from the component to a plate onto which it is attached. A coolant flows through this plate in embedded ducts and removes the heat via convection.
- Spray or impingement cooling of some device with/without vaporisation.
- Convective heat transfer from a fuel pump to the fuel in which it is immersed.

Note that, in all these examples, the heat is transferred directly to a fluid or structure in the immediate vicinity of the source. The applicable structure or fluid can be considered an 'intermediate heat sink', as opposed to the 'terminal heat sinks' (i.e., those in the right-most block of Figure 3). In many (and, until recently, perhaps most) cases, the intermediate and terminal heat sinks could be one and the same. For example, atmospheric air (a terminal sink), flowing over the airframe automatically acquires heat directly from some sources, such as exposed engine components. Another example is the fuel pump (a source) mentioned above, which is immersed in fuel (which could be a terminal sink). In these cases, a 'long range' thermal transport mechanism is not required. Furthermore, from the perspective of the source, waste heat is acquired from it, whereas, from the perspective of the sink, heat is rejected to it by the source. The heat rejection mechanisms are therefore based on the same, or the 'inverse' of, the working principles of the heat acquisition mechanisms.

In many (and in an increasing number of) cases, such local cooling is not sufficient (or practical), and waste heat needs to be transported over larger physical distances to the heat sinks. This is where thermal transport mechanisms are needed. Note that any movement of thermal energy could be considered 'thermal transport', but here it specifically refers to transport over some distance from the heat source, i.e., the terminal sink is not in contact nor in close proximity to the heat source. A thermal transport system refers to a collection and arrangement of components, fluids, sensors, and control means that moves the waste heat from the source to the terminal sinks. This is a broad category and includes cooling/working fluids, thermodynamic cycles (including refrigeration and power conversion cycles), as well as all the components that make these possible, such as pumps, turbines, compressors, heat exchangers, valves, sensors, and so forth. In many instances, a simple liquid cooling loop would suffice. In other cases, for example where the source is at low temperature (i.e., a 'low-grade' or 'low-quality' heat source), a 'thermal lift' is required to reject the heat to the sink, which means that some sort of refrigeration cycle is needed. Means of reclaiming some of the thermal energy in the form of useful work, such as in Rankine cycles, are also an option. Note that many fluids and equipment can fall simultaneously under heat acquisition, transport, as well as heat rejection, as they can perform all of these functions.

The terminal heat sinks refer to the destination of the thermal energy. The most widely used terminal heat sink is the atmosphere. This is because it is readily available and can be quite cold at altitude. However, as alluded above, it could also act as a heat source at other points of operation. Fuel is also a common heat sink, as there is usually much of it available and it can be transported around the aircraft to where it is needed. There is also a thermodynamic benefit of heating fuel before it is combusted. Notwithstanding this, there are obvious dangers and limitations of using fuel as a heat sink, including flammability and the tendency of carbon-based fuel to undergo coking when heated above certain temperatures. Other terminal heat sinks could include the airframe structure or some types of energy storage or conversion mechanisms (i.e., to electricity or useful work).

This classification of thermal management system elements was the main means employed to organise much of this article. First, a description of the environment in which aircraft operate is provided in Section 4, followed by treatments of the most common aircraft heat sources and acquisition means in Section 5, terminal heat sinks in Section 6, and thermal transport means in Section 7.

4. The ambient environment

When analysing the thermal characteristics of air vehicles, an essential consideration is heat transfer to and from the environment in which they operate. One important factor that affects this heat transfer is the temperature of the environment. The air temperature in our atmosphere can vary significantly with location on the surface of the earth, altitude above sea level, and time. For the purpose of performing general aircraft design and performance analyses, the International Standard Atmosphere (ISA) [22] is a widely used idealised hypothetical reference model for calculating the properties of the atmosphere, including air temperature, as a function of geopotential altitude. For this model, it is assumed that the air is free of humidity, static (i.e., no wind), and is of constant composition. The values it provides for the atmospheric properties is ‘average’ for the global atmosphere, but ‘non-standard’ days could be accounted for by adding or subtracting a ‘delta’ temperature value from the standard conditions. A similar model is the U.S. Standard Atmosphere [23].

When designing thermal management systems, the interest is usually more on the extreme climatic conditions that an aircraft may experience during its operational lifetime. To this end, reference models were developed by the United States Department of Defense for several ‘types’ of days, such as a ‘hot day’, ‘tropical day’, ‘polar day’, and so forth, or alternatively, as conditions occurring at specific frequencies, such as 1%, 5%, or 20% of the time. These models are of temperature with altitude and are based on global climatic data. They are documented in U.S. military standards and handbooks (e.g. [24], [25]), but a collated description can be found in [26]. A summary of typical extreme outside air temperature (OAT) ranges employed when considering thermal effects on aircraft are shown in Figure 5. The figure shows temperatures for hot and cold day conditions occurring at 5% and 1% frequencies, as well as ‘extreme’ cases.

The environment will affect heat transfer to/from the vehicle through several factors, most of which will include OAT as a variable in the calculation of the magnitude of their influence. These factors are (quoted from [27]):

1. Aerodynamic heat transfer by forced convection to the skin. (Note that the air adjacent to the vehicle skin is heated due to compression and friction).
2. External radiation from the skin.
3. Solar radiation to the skin.
4. Atmospheric radiation to the skin.
5. Near-field radiation from the hot gas cap around the nose of the vehicle.

These have different levels of influence and depend on the speed of the vehicle and/or other aspects. For example, (1) to (4) are all important at supersonic speeds, but the influence of (3) and (4) relative to (1) depends on the specific problem under consideration [27]. In affecting the temperature of the airframe skin, (1) and (2) usually dominate at hypersonic speeds, but (5) can also become important at sufficiently high Mach numbers [27]. The effect of atmospheric radiation to the aircraft skin (factor 4 in the list above) will be small if the skin surface temperature is significantly higher than the ambient temperature [27].

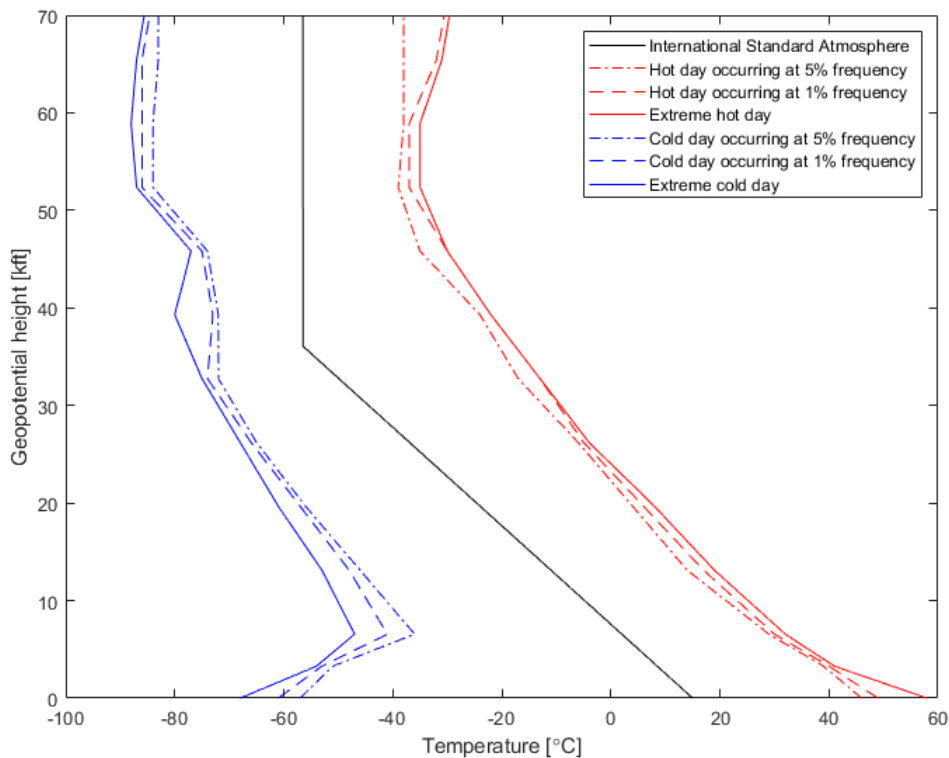

Figure 5: Typical outside ambient temperature design conditions for aircraft based on the international standard atmosphere and the U.S. military handbook, MIL-HNDB-310 [25].

The influence of solar radiation (3) depends on the angle of incidence between the sun and the airframe skin surface under consideration [27]. Solar heating is especially dominant on the ground (in the absence of high aerodynamic convective heat transfer), where it can significantly raise the temperature of the structure of the aircraft. In addition to direct impingement of solar radiation on the aircraft structure, the reflection from the surface of the ground also needs to be considered. Structural heating can have an adverse effect on structural integrity and is of particular concern in aircraft employing composite materials [28]. Means to counter solar heating of the structure include ensuring low skin surface solar absorptivity and high emissivity, which many paints have [28].

The increase in structural temperature increases the cooling loads for the aircraft on the ground. Impingement of solar radiation through windows or canopies of the aircraft has a particularly severe effect on cooling requirements, which can affect the sizing of the environmental control system [28].

For a full description on how to take factors (1) to (5) into account when calculating heat transfer through the airframe skin, in conjunction with salient factors internal to the aircraft, the reader is directed to Ref. [27].

5. Heat sources and heat acquisition

This section contains an overview of the main sources of heat internal to the aircraft and descriptions of relevant trends related to these. The sources covered include those related to current and possible future propulsion systems, the payload (which include waste heat generated by the occupants, galleys, and other cabin equipment) and environmental control, avionics and electrical equipment, actuators, and hydraulic equipment.

5.1 Powerplant system components

Heat sources related to powerplant systems normally include heat soakage phenomena in combustion engines, waste heat from mechanical transmission, electrical powertrain components in electrified propulsion aircraft, and other equipment.

5.1.1 Heat soakage in combustion engines

Heat engines, such as gas turbines or internal combustion engines, can produce large amounts of waste heat through friction (e.g., in the bearings), the compression of air, combustion of the fuel-air mixture, or through other irreversible processes. Although most of this heat is expelled along with the exhaust, a significant portion can be transferred from the gases to the engine structure, substantially raising its temperature. This phenomenon is called 'heat soakage' and must be successfully managed to ensure safe and reliable operation of the engine. It results in increased component operating temperatures and losses in fuel conversion efficiency. As an example of the effects of heat soakage, in gas turbines, it can amount to about 30% of the excess fuel energy in an acceleration from idle to full power [29], [30].

The exact calculation of heat soakage in each engine component requires data of the components, including materials, geometries, and masses, as well as heat transfer coefficients, which can be difficult to obtain or estimate. Therefore, zero-dimensional calculations are normally used to estimate the values for heat transfer and temperature rise in these components [31], [32].

In jet engines, heat soakage calculations can be performed for the Low-Pressure Compressor (LPC), High Pressure Compressor (HPC), Combustion Chamber (CC), High Pressure Turbine (HPT), and Low-Pressure Turbine (LPT). A theoretical and experimental study for a Rolls-Royce RB153 turbofan engine showed that the highest heat fluxes occur in the CC, the HPC and the HPT [33], [34]. The heat transfer coefficients reported for LPC, HPC, CC, HPT, and LPT in this study were 1050, 3350, 3150, 3150, and 850 W/m²K respectively.

Heat soakage can be managed using different heat acquisition means, such as ventilation of the engine compartments using air, convection using engine oil, and, in the case of gas turbines, turbine blade-cooling techniques. These are discussed in the following subsections.

Engine compartment ventilation

Some of the waste heat due to soakage is normally removed from the engine structure by using air ventilation [35]. The air used for this purpose is sourced from ambient (through a ram air duct), the bypass fan duct in turbofan engines, and/or from the compressor stages in gas turbine engines. It is then passed through and over the engine compartments, and/or through turbine blades in which it is employed for convection, impingement, or film cooling [36], [37]. For civil aircraft turbofans, Verseux and Sommerer [35] have identified interrelated challenges for engine compartment cooling. These include:

- Increased operating pressures ratios will lead to higher pressures and temperatures in the primary flow of the engine. This will lead to higher heat loads to be managed.
- Higher bypass ratios of future engines will result in lower fan pressure ratios. This would lower the pressure differential that drives the ventilation and would therefore degrade the cooling capacity.

Engine oil-cooling

Another widely used method to manage heat soakage is to use the oil intended for engine lubrication. The oil acquires waste heat due to soakage from the engine casing and bearings (but also from gearboxes, the constant speed drive, pumps, electrical generators, and so forth) and then rejects it to an appropriate sink. The sinks are normally fuel, using a fuel-oil heat exchanger (FOHE – also called the fuel-cooled oil cooler, or FCOC), or air, by means of an air-oil heat exchanger (AOHE – also called air-cooled oil cooler, or ACOC) [38]–[41].

For the FOHE, the fuel used is normally that which is on its way to the combustion chamber. The resulting heating of the fuel has thermodynamic benefits for combustion and improves fuel efficiency. However, the temperature to which the fuel is increased must be limited to prevent coking, which can damage fuel system components. In some aircraft, fuel can be recirculated back to the tanks. This allows for higher mass flow rates, which increase cooling effectiveness. The AOHE normally uses fan air and is usually intended to only be used if the fuel mass flow rate through the FOHE is insufficient to remove the heat produced.

The characteristics of the oil circulating in the AOHE and FOHE should be consistent with the engine requirements. Currently, most jet engines use synthetic oils, such as MIL-PRF-23699 and MIL-PRF-7808 that are suitable for gas turbine engine demands. These two oils are compatible and may be mixed if necessary [42], [43]. The thermal management system of the engine should be designed to keep engine oil temperature in the range of -10°C to 140°C [44]. Cooling (for all relevant heat sources) using air and fuel is discussed in more detail in Section 6.

Turbine blade cooling

As one of the most important parameters for enhancing gas turbine efficiency, the turbine entry temperature (TET) has been increased significantly over the past few decades. The TET now often exceeds the allowable operating temperatures of the blade materials and cooling is therefore a necessity. Blade cooling technology includes internal and external cooling mechanisms [45], using air sourced via bleed valves from the compressor stages. Internal cooling includes convection and impingement cooling and is usually achieved by forcing air (or another fluid) through passages inside the blades. This mechanism has been developed from single-pass convection cooling to advanced multi-pass serpentine cooling [46]. External cooling techniques include film, transpiration, and effusion cooling. In film cooling, a common technique, a protective layer of air is generated between the hot gas-path flow and blade surface, by ejecting air out from the blade onto its surface. The cooling mechanisms cover blade end-wall, leading edge, trailing edge, and tip cooling [10]. Blade tip cooling is the most critical due to the high thermal load over the tip surface.

5.1.2 Mechanical power transmission

Any mechanical power transmission equipment, such as gearboxes (for example the accessory gearboxes that extract power from the engine for use around the aircraft), couplings, constant speed drives, and so forth, would inexorably produce waste heat because of the friction, gear windage, and oil churning losses generated during their operation. Up until recently, the waste heat produced by such devices was not a major concern. This is because these components were relatively small and did not transmit significant levels of power. However, with the advent of large power gearboxes to reduce fan speed on geared turbofans and the even larger gearboxes destined for the approaching adoption of ultra-high bypass geared turbofans (UHBR GTF), it is projected the waste heat produced would be substantial and would require intensive thermal management. Jafari et al. [47] presented a method for estimating the heat losses produced by planetary gearboxes for UHBR GTF engines. Using lubrication oil for cooling, as described previously under

heat soakage, is the most common way of removing waste heat from mechanical transmission equipment. Section 8.2 is devoted to the discussion of thermal management in UHBR GTF engines.

5.1.3 Heat loads in electrified propulsion systems

Electrified propulsion (of any type) for aircraft is expected to bring forth considerable challenges regarding thermal management. This is because the heat produced by the components of an electrified power train is not expelled from the aircraft with the engine exhaust gases, as in combustion engines. In this section, the main electric power train heat sources (i.e., electrical machines, batteries, power converters, and power distribution) and their associated heat acquisition techniques are covered. A more detailed treatment of the proposed thermal management approaches for electrified propulsion aircraft (EPA) is provided in Section 8.1.

Electrical machines (motors and generators)

A typical current state-of-the-art electrical motor for aircraft propulsion is the 580VDC 260 kW machine used on the Siemens Extra 330LE. It is claimed that this motor provides 95% efficiency and has a power density of larger than 5 kW/kg [48]. For generators on airliners, an example of a current state-of-the-art machine is the variable frequency 250 kVA starter-generator employed on the Boeing 787.

Jansen et al. [49] provide a summary of NASA-sponsored studies of future electrical machines for large electrified propulsion aircraft. For these aircraft, electrical machines would have to be in the megawatt class, efficient, lightweight, and small. The summary is reproduced in Table 1. As can be seen, the main goals are to achieve efficiencies of over 96% and a specific power of at least 13 to 16 kW/kg. If an efficiency of 96% were achieved for the 2.6 MW motor, it would still produce 104 kW of waste heat when operating at its rated power. This is a significant amount of heat to be removed.

Table 1: Overview of megawatt-scale electric machine developments sponsored by NASA [49].

Institution	Continuous power rating [MW]	Specific power goal [kW/kg]	Efficiency goal [%]	Motor type	Speed	Nominal dimensions
University of Illinois	1	13	> 96	Permanent magnet	18,000	Cylinder 0.45 m by 0.12 m
Ohio State University	2.7	13	> 96	Induction	2,500	Ring 1.0 m by 0.12 m
NASA Glenn Research Center	1.4	16	> 98	Wound field	6,800	Cylinder 0.40 m by 0.12 m

Because it plays such an important role in thermal management, much of the research on the development of electrical machines for EPA focus on improving their efficiency [49]–[54]. Much effort has also been devoted to developing superconducting electrical machines (especially with cryogenic approaches [55]), which will allow for significant increases in efficiency. For electrical machines with high-temperature superconductive technology, it is expected that efficiencies exceeding 99% and a power density of above 15 kW/kg could be obtained in the future [56]–[60].

In terms of heat acquisition, electrical machines could be air-cooled, oil-cooled, or cooled using some combination of these [61]. It is expected that air-cooling will not be sufficient for larger EPA. Even for the relatively small X-57, Falck et al. [62] found that the air-cooled motors will reach its temperature limits during climb, which would constrain the climb rate. However, Tallerico et al. [63], showed that an efficiency of >96% could be achieved for the X-57 motors with cooling provided only with the flow from the propeller wake travelling over the outer mould line of the nacelle in which the motor is embedded.

Batteries

The temperature variation in a battery during operation strongly affects its reliability, longevity, and performance. It is therefore essential that the temperature be properly controlled. An acceptable operating temperature range for lithium-ion batteries is reported in the literature to be between around -20 °C to 65 °C [64]. Therefore, both heating and cooling may be needed.

Another crucial consideration regarding battery thermal management is the phenomenon of ‘thermal runaway’. Thermal runaway happens when an increase in temperature becomes self-sustaining and could damage the battery and pose a severe safety threat. Therefore, adequate safety measures need to be implemented to prevent thermal runaway from happening. Such measures include protection circuits and other physical design approaches.

Heat is generated in batteries by means of two mechanisms: Joule heating and through electrochemical processes that lead to changes in entropy [65]. These two mechanisms are accounted for in the following heat balance, which can be used to calculate the heat generated by the battery (\dot{Q}_b) [66]:

$$\dot{Q}_b = -IT \frac{dE}{dT} + I(E - V) \quad (1)$$

On the right-hand side of this equation, the first term represents joule heating, and the second term represents heat generated due to entropy changes. Furthermore:

- I is the current [A] (positive when discharging, negative when charging),
- E is the open circuit voltage [V],
- T is the temperature of the battery [K], and
- V is the equilibrium potential difference [V].

Common categories of mechanisms for heat acquisition in batteries are as follows [67]–[69]:

- *Heat transfer from the battery to air, by means of natural or forced convection.* Convection with air is not expected to be adequate for larger scale applications.
- *Heat transfer from the battery to a dielectric oil in which the battery is immersed (liquid immersion).* Examples of dielectric oils include polyalphaolefins [70].
- *Water-based coolants.* This can be achieved by circulating the coolant through a cold plate on which the battery is mounted.

In recent studies, it was found that cell electrical tab cooling causes slower battery degradation than cell surface cooling [71], [72]. This should be taken into consideration when designing a heat acquisition system for a battery.

An example of how heat acquisition could be performed for the large (megawatt-hour) batteries that will be present on large hybrid electric aircraft can be found in Ref. [73]. In that study, a packaging approach and battery heat acquisition system (BHAS) is introduced that can keep the battery below its maximum allowable temperature of 40 °C. To do this, the BHAS employs a combination of thermal storage and liquid cooling. The liquid coolant is in turn cooled with ram air.

Inverters and rectifiers

Typical efficiencies for currently available power converters (inverters and rectifiers) are reported to be around 98% [74]–[76]. A summary of NASA-sponsored studies of power converters for future electrified propulsion aircraft is provided in Table 2. As can be seen, the goals of these studies are to achieve efficiencies of above 99% and specific power values of between 16 kW/kg and 26 kW/kg.

Table 2: NASA-sponsored megawatt-scale power converter developments [49].

Institution	Continuous power rating [MW]	Specific power goal [kW/kg]	Efficiency goal [%]	Topology	Switch material	Cooling
General Electric	1	19	99	3 level	SiC/Si	Liquid
University of Illinois	0.2	19	99	7 level	GaN	Liquid
Boeing	1	26	99.3		Si	Cryogenic

The heat load generated by rectifiers and inverters (\dot{Q}_{pc}) can be calculated as follows [77], [78]:

$$\dot{Q}_{pc}(t) = V_{T_0}I(t) + r_T I^2(t) \quad (2)$$

where V_{T_0} is the initial voltage drop, r_T is the dynamic resistance, and $I(t)$ is the current. In this expression, the variation of voltage drop is assumed linear with time. This heat must be removed – either through convection with air or with a liquid coolant in a cold plate. As shown in Table 2, Boeing is developing a cryogenically cooled one-megawatt inverter. The cooling on that inverter is intended to be performed with liquid natural gas or hydrogen.

Power distribution

In aviation, both aluminium and copper cables are in use for electricity distribution. However, for high-power applications, despite its lower efficiency, aluminium is the preferred material. This is because of its lower mass relative to copper. Traditionally, cooling for cables that travel through the pressurised section of the fuselage is done indirectly by accounting for the heat produced in the cabin heat balance. The added heat from the cables is therefore managed with increased mass flow rates of air sourced from the environmental control system.

For electrical propulsion systems, the cables would not normally travel through the cabin. In this case, convection (either natural or forced) with atmospheric air may be sufficient for cooling, but this would need to be established on a case-by-case basis.

Power losses in transmission cables can be estimated relatively easy by making use of Ohm's law. To do this, a value of resistance per unit length would be required.

For high power applications, high temperature superconducting cables could be a promising solution for increasing transmission efficiency [79], [80]. However, again, cooling would be required for such an implementation and, depending on how it is done, this may in turn reduce the efficiency gained.

Note that power distribution also includes switches, breakers, buses and so forth. These also produce waste heat and may require cooling. Heat acquisition for these devices could be performed with, for example, convective air or liquid cooling (often using a cold plate).

5.1.4 Fuel cells

Fuel cells, such as hydrogen fuel cells, could also perform the role of supplying electricity in an electric power train. Fuel cells produce heat through the electrochemical reactions taking place within them. Unlike combustion engines, their exhaust heat flow is low, which leads to higher demands on the cooling system [81]. In addition, the operating temperature of a (hydrogen) proton exchange membrane fuel cell is limited to the boiling point of water, which renders the fuel cell a low-quality heat source.

The cooling required for a fuel cell can be determined using the following energy balance [81]:

$$m_s C_{p,s} \frac{dT_s}{dt} = \dot{Q}_{reac} + \dot{Q}_{in} - \dot{E}_{elec} - \dot{Q}_{out} - \dot{Q}_{coolant} \quad (3)$$

where:

- m_s , $C_{p,s}$, and T_s are the fuel cell stack mass, specific heat capacity, and temperature, respectively.
- \dot{Q}_{reac} is the rate of energy liberation determined by the higher heating value of the fuel.
- \dot{Q}_{in} and \dot{Q}_{out} represent the sum of enthalpies of reactants and products entering and exiting the fuel cell.
- \dot{E}_{elec} is the electrical power produced.
- $\dot{Q}_{coolant}$ is heat removed by a coolant.

Three categories of cooling methods are generally recognised for fuel cells [81]:

- *Air cooling.* Cooling air could be passed through the cathode and/or through cooling plates between the cells.
- *Liquid cooling.* In this case, a liquid coolant is passed through cooling channels between the cells, where it collects heat generated by the cells. The heat is in turn rejected to another heat sink (such as air) through a heat exchanger. This is currently the most common method of cooling for fuel cells.
- *Phase change cooling.* Here, waste heat is removed by employing the enthalpy of vaporisation of the cooling fluid. This may be achieved by boiling liquid coolant or allowing/promoting evaporation. One physical means to achieve this is with a heat pipe.

5.2 Environmental control system, occupants, and payload

The environmental control system (ECS) fulfils the function of maintaining acceptable temperature, pressure, and air quality for the occupants, the payload, and some systems. It is therefore a thermal management system in its own right and, more specifically, can be considered to be a thermal transport system. However, some of the components of the environmental control system could act as powerful heat sources to their immediate surroundings, as they reach high operating temperatures due to the compressed air flows or power losses. Common examples are the turbomachinery of the air-cycle machines in the air conditioning packs and the bleed ducts that feed these, as well as electrical motors and compressors for more-electric ECSs. It is therefore important to consider how these components may affect thermally sensitive structures, fluids, or system equipment surrounding them, such as fuel tanks (see, for example, Ref. [82]).

Research developments on environment control systems as thermal management systems are covered in more detail in Section 8.4.

Living occupants (i.e., crew and passengers) can contribute a large amount of heat, in the form of sensible and latent heat. For design purposes, the heat load per passenger is assumed to be around 102 W [83] (when sitting in an environment with an ambient temperature of 18°C). This heat has to be taken into consideration when performing heat balances as part of the sizing of the environmental control system, along with the waste heat produced by other equipment, such as galleys, in-flight entertainment systems, and so forth. Similarly, any payload or, for example, weapons system, that requires cooling need to be accounted for as well.

5.3 Electrical power system

The electrical power system (EPS) is responsible for providing electrical power to different consumers across the aircraft. It includes both electrical power generation (with electrical generators linked to the engines or auxiliary power unit, or with batteries) and power distribution (through power feeders, buses, switches, and breaker circuits). As alluded to in the electrified propulsion section (Section 5.1.3), even though aircraft electrical equipment is relatively efficient, the large amounts of electricity they produce/transfer/transport can still result in considerable waste heat being produced. Because of the increasing consumption of onboard electricity on aircraft, it is assumed that these loads will continue to grow.

The generators are normally located next to the engines and are usually cooled with engine oil. As stated in Section 5.1.1, the heat is then transferred from the oil to fuel on its way to the engine combustion chamber via FOHEs or to cooling air via AOHEs.

Power feeders are wires (i.e. electrical cables) that transport electricity from generators located in the engines or the auxiliary power unit, batteries, or a ground electrical connection, to consumers located around the aircraft [28]. The same principles as discussed under the 'power distribution' heading in Section 5.1.3 apply equally here. The growing adoption of more electric systems on aircraft is leading to higher heat loads from power feeders. For feeders in the pressurised sections of the fuselage, cooling is normally provided by the ECS (i.e., in the sizing and analysis of the ECS, the heat loads from the feeders are added in the cabin heat balance).

As already alluded to, the EPS could also employ batteries to produce electrical power. The same thermal behaviour principles discussed under the 'batteries' heading in Section 5.1.3 apply and will therefore not be repeated here. Another power source for the EPS could be auxiliary power units. These are usually gas generators, so the same thermal management principles as described in Section 5.1.1 are applicable.

5.4 Electrical consumers

Electrical consumers include equipment such as avionics, power electronics, flight control computers (which include the 'Full Authority Digital Engine Control' [FADEC]), in-flight entertainment systems, galley equipment, weapons systems, and so forth. The rapid growth in their use over the past few decades has led to significant increases in the overall electrical power consumption and subsequent waste heat generation [28]. It is expected that this will continue as technology advances and demand for more functionality increases. This is especially anticipated with the increasing electrification of subsystems, such as the environmental control system, ice-protection system, and flight control systems.

The increase in waste heat produced, in conjunction with the increasing miniaturisation of these devices, results in high heat fluxes that present particularly severe thermal management challenges [84]. Complicating the matter is that, although many electrical consumer components can normally operate in a large temperature range, their longevity and reliability may be adversely affected by higher temperatures. This may negatively affect maintenance cost [85]. The waste heat from these equipment is therefore considered to be 'low-grade' (also called 'low quality') [84], as it results in only small, or sometimes even negative temperature differences between the source and the relevant heat sinks. This impedes effective heat transfer. In some cases, the temperature also needs to be controlled accurately and cooled surfaces are sometimes required to have isothermal temperature distributions [86].

Electrical equipment (except those that can be passively cooled) are usually located in electrical equipment (E/E) bays that have dedicated cooling systems (heat acquisition systems in the terminology of this article). In commercial aircraft, these cooling systems usually form part of the air distribution system of the environmental control system (with air being sourced for ventilation from the passenger cabin). However, separate liquid cooling systems, already common on military aircraft, are increasingly being employed to handle the rising heat fluxes [28], especially on more electric aircraft [21]. Liquid coolants used for this purpose are often glycol-water (antifreeze) mixtures, or dielectrics fluids, such as polyalphaolefins. The liquid coolant acquires heat from the equipment, often via a cold plate onto which the electronic devices are attached, and then rejects it to air (sourced from ram, engine fan, or cabin air), or fuel, via a heat exchanger. It is expected that future supersonic transport and electrified propulsion aircraft would make extensive use of liquid cooling.

Sanchez and Liscouët-Hanke [87] presented a thermal risk prediction methodology that can be used during the conceptual design of aircraft avionics/electrical equipment bays. Thermal risk is defined by these authors as the “potential of non-compliance with thermal requirements”, i.e., the potential that some maximum allowable temperature is exceeded at some point in the future operation of the aircraft being designed. Their approach employs a combination of dimensionless numbers and accounts for thermal factors, such as ventilation and temperature stratification in the equipment bays, as well as system integration, to produce a thermal risk level. This risk level can be used to aid in defining the thermal requirements and to design the equipment bay such that the potential of incurring thermal issues later in the design process is reduced.

In some future military aircraft, a major electrical consumer generating enormous amounts of waste heat will be directed energy weapons (DEW). These are covered in more detail in Section 8.3.

5.5 Flight control and other actuators

Traditional hydraulic actuators for flight control surfaces, doors, and so forth, do not produce a significant amount of waste heat [88]. In addition, the waste heat that is indeed produced is normally spread throughout the centralised hydraulic system by the hydraulic fluid and a steady state temperature of the fluid is normally reached at some point in the flight (see next section).

The situation is different with newer, more-electric actuators, such as electrohydrostatic and electromechanical actuators (EHAs and EMAs) [89]. These can produce significant localized waste heat and, in some cases, such as with the aileron EHAs on the Airbus A380, cooling has to be provided. In the case of the A380, part of the wing had to be redesigned to ensure more convective air cooling [88]. Research in more electric actuator thermal behaviour have been devoted to characterising the power losses of both the actuator motors and the associated power electronics [89]–[91], which are the two biggest sources of waste heat in these actuators [89].

Heat management is crucial for the actuator motors, as increased operating temperatures can cause (i) increases in the resistance of the copper windings, which reduces efficiency, (ii) decreases in the reliability of the insulation material around the windings, reducing longevity, and (iii) induce losses in the magnetic materials of the motor, further reducing efficiency [92]. The heat loads produced by the controller power electronics are typically of the same order of magnitude as the motor itself [93]. Excessive heat produced by the actuators could also pose a threat to the surrounding airframe structure and systems. A particular concern are actuators close to the fuel tanks.

Lawson and Pointon presented results for the estimated waste heat produced by EMAs on a more-electric A320-sized aircraft [89]. These can be viewed in Table 3. They have also showed that heat pipes, thermosiphons, and air-cooled cold plates are possible feasible heat acquisition means to ensure the required operating temperature range is adhered to (80°C nominal and 125°C peak temperature).

Table 3: Estimated EMA heat rejection on a more-electric A320-sized aircraft for peak and nominal operating conditions [89].

	Estimated heat rejection [W]					
	EMA motor		Electronics		Total	
Actuator	Peak	Nominal	Peak	Nominal	Peak	Nominal
Aileron	336	121	253	91	589	212
Spoiler	349	126	263	95	612	220
Elevator	129	47	97	35	227	82
Rudder	379	136	285	103	664	239

Woodburn et al. [90] emphasized that addressing the thermal management issues with EMAs need to be focused on both the provision of cooling but also the manner in which the motor is controlled, which could aid significantly in reducing the magnitude of the waste heat produced.

If EMAs or EHAs were to be used on future supersonic transport aircraft, some form of dedicated thermal management system for cooling these actuators will almost certainly be needed.

Finally, apart from actuators, some other type of flight control system components may also require cooling. For example, flight control computers situated in the E/E bays can generate substantial amounts of heat. This could be managed with some of the means discussed in the electrical consumers section (Section 5.4).

5.6 Hydraulic systems

Centralized hydraulic systems operate at high flow rates to fulfil the movement rate requirements of a range of aircraft actuators. Owing to pipe network friction losses and the mechanical and fluid inefficiencies of the pumps, waste heat is generated and must be managed. In addition, the heat generated by hydraulically powered actuators is effectively taken up by the hydraulic fluid itself and is subsequently distributed throughout the system. Exposed pipes naturally dissipate some heat to the environment, but this is often not enough to maintain the fluid at optimal temperatures. Current system designs incorporate a range of heat exchange mechanisms to control the fluid temperature. A typical approach is to employ fuel-submerged hydraulic/fuel heat exchangers.

Modern aircraft, such as the Airbus A380 and A350, have hydraulic systems with high design pressures (up to 5000 psi), leading to increased thermal loads from the hydraulic fluid. The A380 makes use of an air-hydraulic heat exchanger with a dual matrix and a back-up fuel-hydraulic heat exchanger, located on the return line, upstream of the reservoir. The A350 hydraulic thermal management is more sophisticated, as provision is made for both fluid heating and cooling. Two submerged fuel-hydraulic heat exchangers, along with a set of temperature control valves, keep the hydraulic fluid close to the design temperature of 20 °C [94].

In continuous pursuit of improving performance, hydraulic systems are pushed towards higher operating pressures, with a more narrowly controlled operating temperature. Maintaining the temperature close to the design value ensures the fluid viscosity remains optimal. This is important to lubricate components and to minimize system leakage flows. Most reviewed research aims to provide modelling tools, which have the capability to estimate the performance of different architectures in the context of achieving the temperature control goals.

Architecture variations with a combination of centralized, electrified, and federalised hydraulic circuits have also been investigated [94], [95]. Such variations result in new integration challenges, as electrically driven pumps need to be coupled to the high-power electric distribution system and federalised hydraulic circuits (such as in, for example, electro-hydrostatic actuators [96]) cause localised heat loads.

A wide range of thermal modelling techniques for hydraulic systems is used. A simple approach is to represent the fluid circuit as a single node and then applying the thermal load of each component [97], [98]. This results in an average operating temperature, which can be used to investigate mission level variations of the thermal loads. In other work, lumped capacitance thermal node network approaches were employed to simulate dynamically the temperatures for each component of the architecture, such as heat exchangers and actuators [99]–[101].

6. Heat rejection and aircraft terminal heat sinks

Currently, in most applications, there are ultimately only two terminal heat sinks to reject heat to on aircraft – the ambient atmospheric air and on board fuel [21]. All other heat acquisition methods eventually only serve to transport thermal energy to these two sinks. For example, even though the engine structure may heat up substantially during the operation of a supersonic aircraft, all the heat is eventually transferred to the atmosphere (although this might only be some time after the aircraft has landed). Indeed, in flight, if the aircraft is flying sufficiently fast, ambient air will become a heat source, rather than a sink, and the aircraft will have to rely solely on the fuel for waste heat rejection.

In this section, the main concepts and developments related to these two sinks are described in detail. This is followed by a subsection in which a selection of other and potential future heat sinks is briefly described.

6.1 Atmosphere (air cooling)

Because of the low temperatures that could be experienced at altitude, it is often useful to employ ambient atmospheric air as a heat sink. In fact, because of its ubiquity, air is the most widely used heat sink on aircraft. The technology readiness level (TRL) for air cooling systems in aviation therefore tend to be high [102].

However, because of compressibility and viscous effects, the actual temperature on the skin of the aircraft could be substantially higher than ambient. Specifically, three relevant temperatures are usually considered in thermal analyses:

- ambient air temperature,
- ram air temperature (attained where air is brought to a stop relative to the aircraft, such as at the leading edge or ram air inlets), and
- adiabatic wall temperature (also called recovery temperature), which is the temperature adjacent to the skin of most of the exposed surface of the aircraft.

For lower Mach numbers, the ram and recovery temperatures are defined in Equations 4 and 5, respectively.

$$T_{ram} = T_{\infty} \left(1 + \frac{\gamma - 1}{2} M^2 \right) \quad (4)$$

$$T_{rec} = T_{\infty} \left(1 + \frac{\gamma-1}{2} r M^2 \right); r = \sqrt{\text{Pr}} \quad (5)$$

In the above equations, T_{∞} is the ambient atmospheric temperature as calculated by the atmospheric model, γ is the ratio of specific heats for air, M is the Mach number, r is the recovery factor, and Pr is the Prandtl number of air. These temperatures are depicted in Figure 6 for a hypothetical flight of a commercial transport aircraft on three different types of climatic days.

Heat is usually rejected to the ambient air by three means: using a ram air cooling system, sourcing air from the engine bypass duct or compressor stages, and/or by employing ‘skin heat exchangers’ (also called surface heat exchangers). Heat rejected to the ambient air through the structure at leading-edge locations for the purpose of anti- and de-icing could be added as a fourth means. These are covered in the subsections that follow.

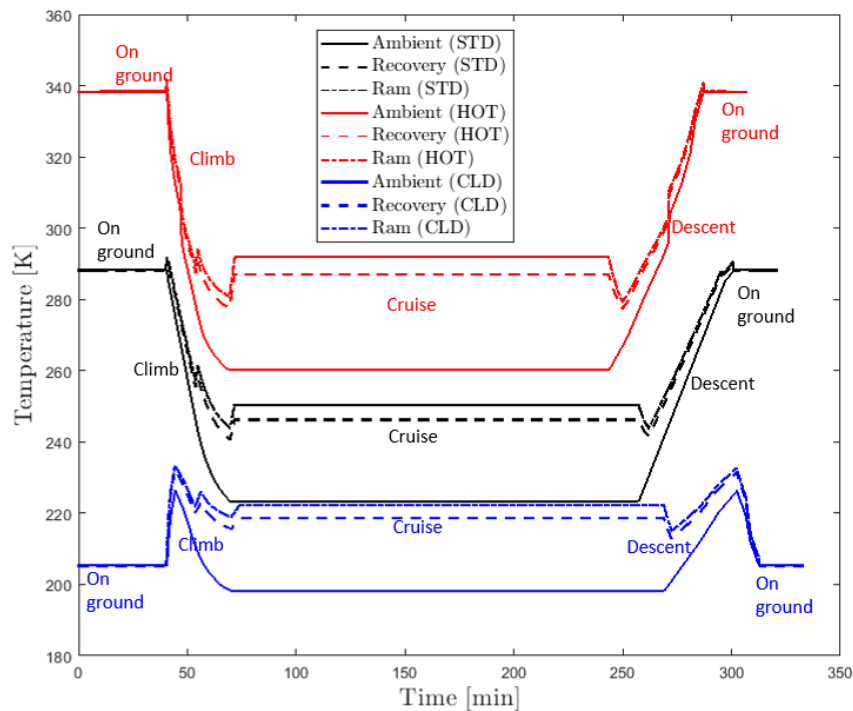

Figure 6: Temperatures experienced by an aircraft climbing from sea-level, cruising at 10,000 m and then descending back to sea-level on MIL-HNDB-310 [25] standard, extreme hot, and extreme cold days.

6.1.1 Ram air cooling

A ram air system (Figure 7) employs the dynamic pressure created by the movement of the aircraft to ingest air into a duct [28]. This air then passes across an air-to-air or air-to-liquid heat exchanger to acquire waste heat collected from aircraft systems, after which it is expelled overboard [28]. When stationary, or travelling at low speeds on the ground, a fan is required to pull in air. The addition of a fan system to pull in air on the ground adds mass and complexity.

Because of their relative simplicity and effectiveness (rejecting more heat per volume than skin heat exchangers [28]), ram air systems are widely employed on aircraft of all types. For example, for internal combustion engines, the air ingested is often used to collect waste heat by flowing directly over baffled cylinder housings, or across a radiator. They are also extensively employed for providing the cooling in air conditioning packs on many types of commercial and military aircraft.

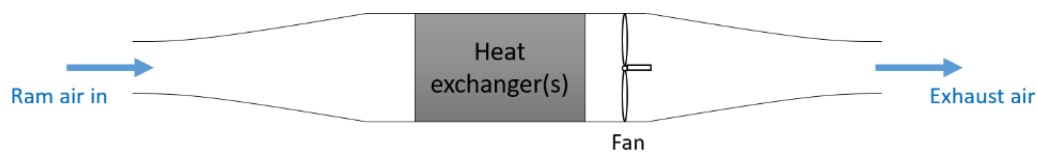

Figure 7: A ram air cooling system (adapted from Ahlers [28]).

A major disadvantage of ram air systems is that they can cause significant drag (referred to as ‘cooling drag’). This drag originates from the loss of momentum that the air experiences when travelling through the system. Careful design of the inlet and outlet (see Ref. [103]) of the system is required to keep this drag to a minimum. Submerged NACA inlets [104] are often employed, because of their advantageous drag characteristics. For the outlet, the drag can be alleviated to some extent by making use of the ‘Meredith’ effect. This effect, famously employed on the North American P-51 Mustang, involves expelling the air from the ram air system in such a manner that some useful thrust could be obtained [105]. The Meredith effect was recently employed in a study involving the design for a cooling system for the ESAero ECO-150R turboelectric aircraft [15]. In that study, it was shown that the total drag of the cooling system during cruise was about 2 to 3% of the overall drag.

Ram air systems are also problematic on combat aircraft requiring low heat and electromagnetic signatures for stealth purposes [106], [107]. The sizes of these systems have therefore been limited on these aircraft, compounding thermal management problems. This has led to an increase on the reliance on fuel as a heat sink [106]–[108].

On turboprops and open rotor engines, ram air (scooped up with NACA ducts) is used to provide ventilation for the engine compartments surrounding the compressor, combustion chamber, and turbine (referred to as ‘accessory zones’) [35], as well as for turbine blade cooling. For ducted turbofans, ram air is more likely to be used for ventilation in the nacelle accessory zone [35], whereas engine fan air is employed for ventilation in the accessory zones around the engine core (see next section).

Looking to the future, it is expected that electrified propulsion aircraft will rely more extensively on the use of ram air systems for cooling than current aircraft, because waste heat is not rejected primarily as part of the engine exhaust as is the case with gas turbines. Therefore, these systems will have to be designed with great care, as the additional drag, power off takes, and mass that they may elicit could significantly diminish the efficiency gains these propulsion concepts offer.

6.1.2 Engine fan and compressor air

Another popular method for performing cooling using atmospheric air on gas turbine propelled aircraft is to reject waste heat to the engine bypass air. This is a lucrative option, because of the proximity of the fan air to many components and systems in the engine that require cooling. However, because the air has been compressed as it passed across the fan, it is at a higher temperature than ram air, which diminishes its ability to act as a heat sink relative to that of ram air. Air from the compressor stages can also be used for cooling purposes, but this air is at even higher temperatures due to higher pressures and incurs more severe penalties on specific fuel consumption. It is therefore limited to cooling equipment operating at far higher temperatures, such as turbine blades. In Figure 8, several means of employing fan and compressor air for cooling on turbofan engines are illustrated.

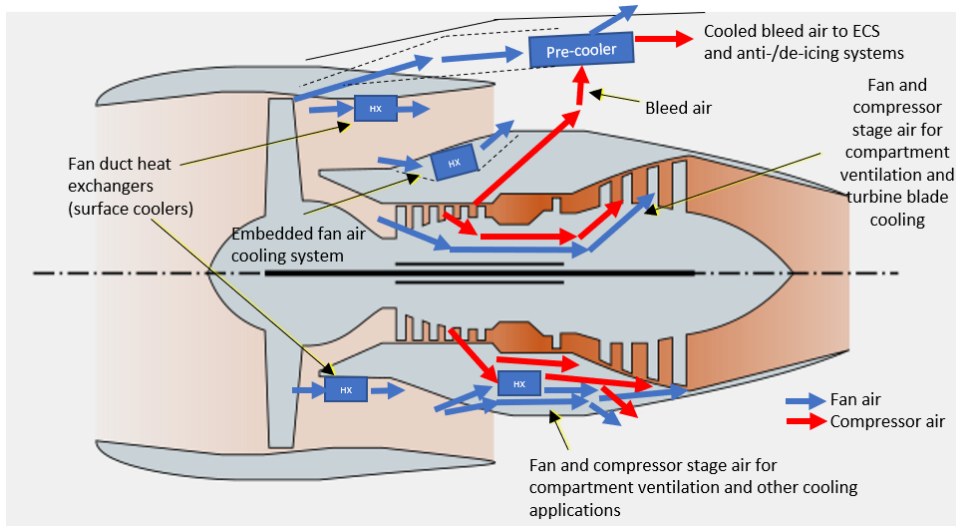

Figure 8: Options for using fan and compressor stage air and possible heat exchanger locations for cooling purposes on gas turbine engines (turbofan image generated using Simcenter Amesim software).

One common way to employ engine fan air for cooling is to ingest it into the engine core compartments through inlets in the cowlings [35]. The ingested air is used to provide ventilation of engine equipment located in these compartments. Engine fan air has also long been used to pre-cool air bled from the higher compressor stages destined for environmental control and ice protection. In this case, the fan air is also bled from the engine and the pre-cooler heat exchanger is situated external to the engine (often in the pylon) [109]. However, in some engines, there are ‘annular’ heat exchangers for pre-cooling in the fan bypass stream [110].

As discussed previously, another way in which fan air could be used is to cool engine or engine equipment oil by means of an air-oil heat exchanger (AOHE or ACOC) situated in the bypass duct or in an embedded air-cooling system. An example of such oil-cooling systems is the ACOC used to provide cooling for the Integrated Drive Generator (IDG) on many civil aircraft engines.

On tactical military aircraft, fan air has only been adopted for cooling since the emergence of 5th generation fighter aircraft [109]. This was done to reduce the reliance on ram air cooling systems, which negatively affects the stealth properties of these aircraft. In this case, the heat exchangers are embedded in the fan stream, albeit downstream of higher fan stages than in civil aircraft, because of space constraints. This location results in the air being at higher temperatures than with civil aircraft applications, limiting its cooling capacity [109].

As stated, employing fan air for cooling is lucrative because of its proximity to equipment requiring cooling. Furthermore, it decreases the number of drag inducing inlets and outlets on the airframe. However, there is still a significant performance cost associated with engine fan air-cooling. This is because bleeding the fan air or inserting a heat exchanger in the fan stream produces a pressure drop, which leads to a thrust penalty and consequently to an increase in specific fuel consumption. Other challenges relate to the integration of fan air cooling systems into the engine, where there are space constraints. The adoption of drag-reducing ‘slimline’ nacelles [111] for ultra-high bypass turbofan engines on civil aircraft may further reduce the available volume for these systems [112].

Much work is being undertaken to address these challenges. The focus is especially on improving heat exchanger performance, where advances in additive manufacturing, materials, and new geometries may result in more effective heat transfer at reduced occupied volume and mass. The reader is referred to Section 7.1.1 for more information in this regard. These efforts are currently especially prevalent in military aircraft, where options are being explored for making use of low

stage fan air possible without breaching space constraints or affecting performance too severely. Such efforts include investigations into incorporating novel embedded heat exchangers or integrated heat transfer elements into the fan stator [109].

Furthermore, there is ongoing work to study and develop fighter (and potentially supersonic transport) aircraft 'double bypass' (three-stream) engines that have variable cycles [109], [113], [114]. These engines provide adjustable bypass and fan pressure ratios that enable either high efficiency or high thrust, depending on the requirements of a specific operational situation. Therefore, in essence, the engine operates as a high-bypass turbofan at subsonic speeds and as a low-bypass turbofan or turbojet during supercruise or combat manoeuvring [114]. In these engines, the outer bypass stream of air (referred to as the 'third stream') has been proposed as a potential heat sink to which waste heat from the engine and aircraft could be rejected [109], [113], [114]. It would be a convenient heat sink for the same reasons as traditional fan air, but moreover because the temperature of this air is lower than the higher stage fan air used on current fighter aircraft.

Finally, compressed air could be used for cooling in an interesting manner by making use of Ranque-Hilsch vortex tubes [102]. These are devices that pass a compressed gas through a swirl chamber to create a vortex, which can be used to split the gas into hot and cold streams. They contain no moving parts and can use air rather than dedicated refrigerants, but suffer from relatively low efficiency [115]. Affonso et al. [102] states that vortex tubes may potentially have benefits in improving environmental control system efficiency, but place their technology readiness level at less than 3 (for use in aviation).

6.1.3 Surface/skin heat exchangers

As stated in the previous subsections, ingesting air for cooling results in momentum loss of the air and subsequent performance degradation of the aircraft. One way to avoid this is to reject the waste heat directly through the skin of the wing, fuselage, or other exposed areas of the aircraft, to the adjacent ambient air stream instead. This can be achieved with 'surface heat exchangers' (also called 'skin' heat exchangers).

In surface heat exchangers, the hot fluid (which could be, for example, oil, water, air, or some other cooling fluid) is directly in contact with the airframe skin, which, in turn, is directly in contact with the ambient air. Ambient air is therefore not ingested, and the setup is subsequently 'drag-less' (if there are no heat transfer-enhancing fins on the ambient side). However, this is not necessarily true, as heating the skin surface heats up the boundary layer on the ambient side, which could render any disturbances in the flow more pronounced. This may lead to earlier transition and separation of the flow, leading to an increase in drag [116]. Nevertheless, the heated boundary layer may also have positive effects on the drag. For example, Kallath et al. [117] have shown that heating a wing (i.e. to expel waste heat from the aircraft systems) can provide for improved aerodynamics. They considered the effects of the Reynolds number, angle of attack, heat exchanger location, and the magnitude of heat flux on the boundary layer of the wing. The results of this study indicated a 2.5% increase in lift coefficient and a 1.6% reduction in the drag coefficient at an optimal combination of these parameters.

Surface heat exchangers have been employed on aircraft since the early days of powered flight. They were common in the fuselages and wings of early piston-powered racing and military aircraft [116]. In one extreme example, the Supermarine S.6b, the cooling requirements were so stringent that the aeroplane required surface heat exchangers covering much of the wings, some parts of the fuselage, and even the top surfaces of the floats it used to land and take-off on water.

However, with the advent of gas turbine engines, where heat is mostly rejected as part of the exhaust, the nature of cooling requirements changed, and skin heat exchangers became less common. This changed, to some extent, with the increasing use of power-hungry avionics, renewing interest in skin heat exchangers. The Airbus A320 is one example where a skin heat exchanger is employed to help cool avionics [118] (Figure 9). In this case, the space between two forward fuselage frames is closed with a thermally insulating material sheet to create a duct through which air heated by avionics could travel. This air is in direct contact with the fuselage skin between the frames, which, on the other side, is exposed to cold ambient air. The air is therefore cooled while travelling through the duct, after which is blown over the avionics again, to make a closed circuit. This skin heat exchanger is in operation in the air and on the ground on cold days. When on the ground in normal and hot conditions, air is instead ingested from outside and blown directly over the avionics.

Pang et al. [118] performed experimental studies on air-air skin heat exchangers for cooling high power electronics. They have shown these heat exchangers to be effective without unduly affecting aircraft performance. Kellerman et al. [119] studied the potential use of skin heat exchangers to remove the waste heat produced by hybrid-electric drive trains. They found that, for all sizes of aircraft considered, surface heat exchangers could provide cooling at the same order of magnitude as the waste heat produced.

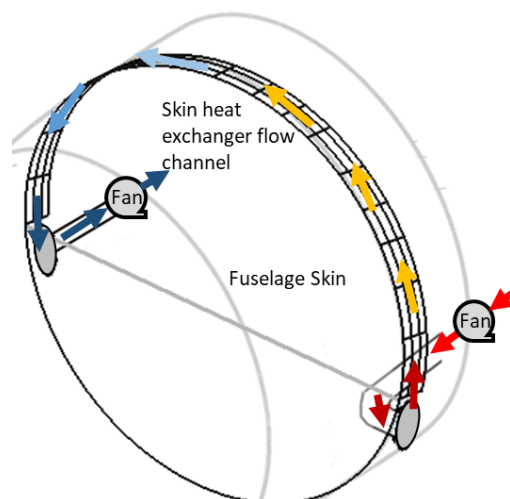

Figure 9: Air/air fuselage skin heat exchanger similar to that used on the Airbus A320.

Concepts have also been put forward in which skin heat exchangers are employed in conjunction with engine fan air rather than ambient air. For example, Sousa et al. [40] studied the merits of using a skin heat exchanger in the engine bypass duct for cooling engine oil. This would have the benefit of not causing a pressure drop in the bypass air. The concept they considered consisted of an oil circuit embedded adjacent to the secondary flow path in the shroud of the primary-secondary flow separator, along with cooling fins protruding into the secondary flow. Using a special wind tunnel set-up and a numerical analysis procedure to investigate the heat transfer performance of this setup, it was found that it could provide up to 76% of the oil cooling demand at take-off [40].

6.1.4 Ice protection system

Ice protection systems are one of the few systems on aircraft that demand a large amount of heat for their function. They maintain a surface at a high enough temperature to prevent ice formation or melt existing ice build-up. Typical surfaces requiring protection are sections of the leading edge of the wing, engine inlet, air speed measurement probes, waste-water outflows and windshields or

canopies. For the larger surfaces requiring substantial heat, traditional systems make use of a mass flow of hot engine bleed air from the low pressure or high-pressure compressor stages. Since the wing leading edge section may be part of a high lift slat system and can be far away from the engine bleed air source, complex ducting arrangements are required to transport the hot air. Alternative designs produce the heat locally via an arrangement of electrically powered heating mats embedded in the surface structure.

Modelling of the ice protection system focuses on two main aspects: (i) establishing the ice accretion characteristics of the surface under protection and (ii) determining the heating power requirements. A common thermal modelling approach is the zero-dimensional heat balance method [120]. This method aids in swiftly determining the heating flow required, by balancing convective, latent, and dissipative heat losses and accounting for the melting or evaporation of the ice on the surface under consideration. In other work, one-dimensional heat transfer models were used to estimate heat transfer between the bleed air piccolo tube, structural elements, and the compartments [121].

A wide range of alternative technologies to current bleed air and electric heating approaches have been investigated, mainly with the purpose of increasing system efficiency and simplicity and to reduce mass [122]. In the context of thermal management, loop heat pipes (LHP) are one such option, which could enable the IPS to become a heat sink for other airframe heat sources.

An extensive literature summary is provided in [123] on LHP design investigations for aircraft anti-icing. In one major study in this field, the engine cowl anti-icing system of the global hawk UAV, which uses heat extracted from the hydraulic system, was designed and experimentally tested. [124], [125]. The performance results showed that the system exceeded CS-25 ice protection requirements, with a total system mass of 18.5 kg, a ΔT across the hydraulic heat exchanger of 17.5 °C, and a total power delivered to the surface of 3.8 kW.

One major limitation in the past for LHPs in aircraft anti-icing was the achievable pressure difference by the capillary action wick. This ΔP is required to be larger than the system pressure losses, which increase with transport distance. Cowl anti-icing using LHPs in the global hawk UAV was possible due to the proximity of the cowl to the hydraulic system and the relatively small size of the cowl compared to larger civil aircraft engine intake diameters. New developments in wick materials [126] have shown a drastic increase in achievable pressure differential of the LHP, by up to 3.5-fold, which is estimated to extend the working distance of LHP from current 8-10 m to 28-35 m.

6.2 Fuel system

Employing fuel as a heat sink on aircraft is attractive for a number of reasons. These include:

- *Availability.* There are normally large quantities of fuel on board (relative to the mass of the aircraft). This availability mostly dispenses with the need to introduce other types of sinks or cooling fluids on the aircraft. Because it is an internal resource intended primarily for propulsion, it does not affect drag or add additional mass. However, where additional pumps and piping are required to transport the fuel for cooling purposes, higher power offtakes and mass would indeed be incurred.
- *Better cooling effectiveness than air.* Hydrocarbon fuels generally have more favourable heat transfer properties than air and is therefore a more effective coolant.
- *Proximity to systems requiring cooling.* Several system components usually surround the fuel tanks on aircraft, including hydraulics, environmental control systems, and pneumatic

components. Fuel is therefore a nearby heat sink that could be used. Fuel also travels to the engines, where it could be used to cool engine systems.

- *Low temperatures.* Fuel temperatures can decrease significantly when flying at high altitudes at subsonic speeds. In some cases, heating may even be required to prevent fuel from freezing. However, because of the 'thermal inertia' of the fuel, this cooling process can take some time. The converse happens when flying at supersonic speeds, where it can take some time for the fuel to heat up due to aerodynamic heating of the airframe. This delayed heating can render the fuel at lower temperatures than the ambient air for considerable lengths of time. Such low temperatures of the fuel are favourable, as it could ensure high temperature differences between heat sink and source are maintained.

Of course, there are also a number of obvious disadvantages and safety concerns when transferring heat to fuel. These are discussed later in this section.

Examples of components/subsystems that can be cooled by fuel, as well as the means by which this is achieved, are as follows:

- *Engine and/or electrical generator lubrication oil.* As discussed in Section 5.1, cooling oil using engine feed fuel through FOHEs is a widely used practice. It has the double benefit of cooling the oil, while the heated fuel also improves the thermodynamic efficiency of the engine. This is by far the most common way in which fuel is used as a coolant.
- *Hydraulics.* A centralised hydraulic system could be cooled with fuel by having a hydraulic oil/fuel heat exchanger submerged in fuel in the fuel tanks or situated outside the tanks.
- *More electric flight control actuators.* If electrohydrostatic actuators are employed instead of conventional hydraulic actuators, they could be cooled by cooling the oil used by them with a FOHE.
- *Electrical consumers.* These include avionics, power electronics, and flight computers, such as the FADEC. If fuel is employed to cool electrical consumers, it would normally be by means of an intermediate liquid cooling loop.
- *Compressed air-cycle machine air.* In certain cases, such as in supersonic flight, the temperature of compressed air from an ECS air-cycle compressor may be unacceptably high, even after exiting the secondary ram air heat exchanger. In such a case, fuel could be used to further cool down the air before it moves to the air-cycle cooling turbine. This can be achieved by using a fuel/air heat exchanger. Such an implementation was employed on the Concorde [127].
- *Fuel pumps.* The fuel pumps themselves generate heat, which is transferred to fuel in which they are submerged.

Fuel that is heated outside the tanks and not immediately employed for combustion can be recirculated back to the tanks [8], [38], [128]. By doing this, the large 'thermal inertia' of the fuel in the tanks can be exploited (although this inertia reduces as fuel is consumed). There is much opportunity for exploring how heat could be distributed in a controlled manner amongst multiple tanks, in order to maximise this heat sink capacity.

There are safety concerns regarding high temperatures in fuel tanks, which must be taken into consideration. In particular, fuel flammability exposure must be limited [129], which can be done by inerting the fuel tanks.

Nevertheless, even with inerting, heat cannot be added to the fuel indefinitely. This is because fuel at high temperatures destabilises and undergoes coking, which damages system components. There are ways to increase the allowable temperatures, which include the addition of fuel additives

[109], deoxygenation systems [130], or simply using a fuel specifically designed for higher temperature use, such as JP-8-100 [9], [131], [132], which is a military fuel. Such options are worth investigating for future aircraft thermal management applications and work should also be done to determine the thermal management characteristics of sustainable fuels.

Inevitably, passing too much heat to fuel will cause it to reach its maximum allowable temperature limit. If this happens, the aircraft has reached what is known as its ‘thermal endurance’ limit [2], [7], [8]. Thermal endurance that is less than endurance based on fuel available for propulsion is a major problem on modern tactical military aircraft and has led to substantial research and development work in aircraft thermal management.

Other issues with using fuel as a heat sink relate to the quantity available on board. As aircraft become more efficient, less fuel is needed for propulsion. This leads to less fuel available as a heat sink. In addition, fuel quantity diminishes as the aircraft advances in its mission. This leads to diminished heat sink capacity as the mission progresses.

A comprehensive summary of studies involving fuel for thermal management on aircraft is provided in Table 4. As can be seen from these studies, research on thermal management using fuel is focused on several different areas, which include modelling approaches, improving fuel thermal stability, reducing heat loads from the fuel system itself, investigating fuel system architecture topologies for improving thermal management, and flammability reduction. These are described next in dedicated subsections. Note that the type of fuel covered here is primarily traditional hydrocarbon-based fuels, especially kerosene. Regardless, some of the concepts applies to alternative fuels as well, such as hydrogen, biofuels, and synthetic fuels. However, there is a paucity in the literature of studies involving the thermal management implications of the alternative fuels – something that needs to be addressed.

Table 4: Studies on fuel for thermal management on aircraft.

Study(ies)	Type of aircraft	Main purpose of the study	Main heat loads	Main heat sinks	Main conclusions
Ho et al. [131] (1997)	Fighter/attack (McDonnell Douglas F/A-18)	To investigate aircraft level effects of using JP-8+100 fuel (a fuel developed to improve thermal management).	Engine oil, gearbox oil, radar, ECS air, hydraulics.	JP-8+100 jet fuel.	The use of JP-8+100 enabled an increase in cooling capacity of the TMS of up to 40% (F/A-18 C/D), 26% (E/F), and has growth potential. Introducing a ‘hot’ tank can limit fuel bulk temperature increases and ram cooling required.
Fischer [132] (2006)	Military long-range air vehicle system	To investigate future fuel heat sink technologies (an in-line fuel deoxygenation unit; new thermally efficient fuel pump designs; electric vapour cycle system for ECS).	Avionics, engine and oil, FADEC, ECS, and hydraulics.	JP-8 fuel jet fuel.	New fuel pump designs can reduce thermal loads to fuel considerably. Deoxygenation could potentially enable higher fuel temperatures, increasing its capacity as a heat sink.
Donovan et al. [128] (2015)	Tactical fighter	To investigate different fuel pump types in a fuel TMS (FTMS) to determine impact on overall performance.	Fuel pumps, avionics, engine and generators (through oil), FADEC, ECS, and hydraulics.	Fuel.	The variable displacement pump provided a substantially better thermal margin (difference fuel temperature and maximum allowable fuel temperature) for the fuel than the centrifugal pump. However, this should be traded off with the lower mass/volume, and cost and higher reliability of a centrifugal pump.
Seki et al. [38] (2015)	Turbofan-powered civil transport aircraft	To investigate an air/fuel integrated TMS employing a vapour cycle system for the refrigeration unit of the ECS.	Cabin heat loads (those normally managed by the ECS).	Ram air and fuel (focus is on increasing the use of fuel as sink in safe manner).	The proposed TMS solution was effective in reducing fuel burn. Fuel temperature reaching maximum limits may be problematic, especially on hot days.

Doman [133] (2015)	Business jet-sized aircraft (based on Gulfstream IV)	To determine optimum cruise altitude to maximise thermal endurance and range.	Aircraft subsystems (100 kW).	Fuel: employs recirculation; fuel cooled by fuel-air HX on return to tanks.	Several expressions were derived for determining altitude at which minimum final tank temperature occurs under different conditions.
Qian et al. [134] (2016)	Fighter	To estimate fuel temperature during flight and assess optimum air/fuel heat exchanger size. One-dimensional thermal model was built with the one-dimensional CFD software tool FLOWMASTER, while convective heat transfer coefficients were estimated using the CFD tool FLUENT.	Oil and, hydraulic systems, cabin and airborne electrical equipment.	Fuel: employs recirculation; fuel cooled by fuel/air HX on return to tanks.	The optimum power for the fuel/air HX was found to be 10 kW. The method employed could be used to predict fuel temperature evolution without the need for flight tests.
Alyanak and Allison [135] (2016)	Supercruise concept aircraft	To investigate fuel TMS considerations in the aircraft conceptual design sizing process. Several mathematical expressions were developed for different heat loads, sinks, etc. These was implemented into four different fuel TMS architectures.	Aircraft systems (heat transported to fuel with a thermal lift cycle).	Fuel (as implemented in different fuel TMS architectures employing recirculation).	The results showed that fuel thermal loads can strongly constrain the design and this influence is dependent on the fuel tank and recirculation architecture employed.
Doman [136]–[138], Sigthorsson [2], [3], [8], [139]–[141] Huang et al. [142], Oppenheimer [7] (all closely-related thermal endurance, fuel tank topology, and control studies). (2016 - 2020)	Fighter	Investigating effects of fuel flow control [136], [137], topology and control [138], as well as output and recirculation tank temperature regulation [8] on aircraft thermal endurance. Through using dimensional analysis, the fuel TMS configuration was tested experimentally in Ref. [142]. The study was expanded to using robust control to regulate temperature and altering between single, dual, and mixed tank topologies using robust control [2], [3]. The effects on control of fluid transport delays in the TMS was taken into account in Ref. [7]. In Ref. [139], the dynamic modelling of the TMS was improved by enhanced control and by spatially discretizing the dynamic thermal models to replace steady-state equations. With Ref. [140], the control scheme is simplified and extended to “explicitly address operation when flight endurance is limited by thermal constraints”. The steady state	Aircraft systems (heat transferred to fuel via VCS), fuel pumps, and engine oil.	Fuel with cooled recirculation. Fuel temperature limited to 360 K in tanks and to 421 K to engine.	The thermal endurance of the notional fighter could be extended by: <ul style="list-style-type: none"> • using a designated tank for recirculation and another as reservoir, rather than recirculating to one single tank array. • using a smaller recirculation tank fuel mass, as this improves the control response. • providing a controllable fuel flow topology, and • adding output temperature, recirculation tank temperature, and recirculation tank level regulation [8]. <p>With the experimental work [142], it was shown that, using dimensional analysis and water as surrogate for the fuel, similitude could be obtained. The experimental results matched the modelling results. The number of hypothetical missions where thermal endurance does not limit the flight endurance is increased further by using the dynamic multi tank topology robust control strategies of Refs [2], [3], compared with employing either single or dual tank configurations exclusively. The predictive control used in Ref. [7] could adequately handle the fluid transport delays in the system. The improved modelling in Ref. [139] provided more flexibility, better performance, and enhanced control. The usefulness of the scheme for mission planning and ‘online’ (real time) thermal endurance prediction was further underpinned by the studies in Refs. [140], [141].</p>

		implications of this simplified, extended control scheme are investigated in Ref. [141].			
Jasa et al. [107] (2018)	Supersonic fighter	To use a “coupled aerothermal-mission model” to optimise the trajectory of a supersonic aircraft subject to thermal constraints.	Aircraft systems (up to 100 kW) and aerodynamic heating (up to 500 kW).	Fuel with cooled recirculation. Fuel temperature limit in tanks: 312 K.	The results showed that fuel thermal constraints could have an impact the optimum trajectory for a supersonic aircraft. It is suggested by the authors that thermal management needs to be considered much earlier in the design process.
Oppenheimer et al. [5] (2018)	Fighter	To investigate how fuel pump sizing affects thermal endurance.	Engine oil, aircraft systems (heat transported to fuel with a VCS), and fuel pump.	Fuel with cooled recirculation. Tank temperature limit: 350 K.	Pump sizing can have a considerable effect on the thermal endurance of a fighter aircraft. Lowering the capacity of the primary fuel pump in the two-pump system studied significantly reduced the thermal energy transferred to the fuel.
McCarthy and Jackson [143] (2019)	Fighter	Quasi-random and surrogate uncertainty analyses were combined to assess risk (of fuel temperature limits being breached) due to varying fuel thermal properties.	ECS, pumps, and other aircraft systems.	Fuel with recirculation (temperature limited to 333 K in tanks).	The fuel specific heat was found to be the most influential variable (the others were density, viscosity, and thermal conductivity). The optimum number of samples for the study was found to be 200 and recommendations were made to use no less than 100 samples.
Van Heerden et al. [82] (2019)	Single-aisle civil jet transport	To investigate the effect of more electric systems surrounding the fuel tanks on the fuel temperature behaviour.	Air-conditioning packs and ice protection system.	Fuel in tanks.	The thermal loads imposed by the more-electric systems are of lower magnitude than more conventional systems, but the benefit of this is small. However, considering local effects on the temperature of the fuel may highlight the favourability of the more electric systems more strongly.
Kellermann [144] (2020)	A 190-seat, 1,300 nm range hybrid electric aircraft with entry into service of year 2035+	To assess the feasibility of using fuel as a heat sink on future civil transport aircraft.	Electric propulsion system (126.1 kW).	Fuel. Two concepts were considered: 1) active hot fuel circulation using ‘wing-integrated fuel heat exchangers’ (WIFHE) on the inside of the top and bottom wing surfaces, and 2) heat exchangers placed inside the existing tanks. Fuel temperature limit: 400 K	Concept 1 provided adequate cooling, except during taxi. Concept 2 did not provide adequate cooling. Concept 1 improved fuel burn by between 0.0% and 0.6% compared with a ram air cooling system, depending on the system mass for Concept 1. Flammability was not considered.

6.2.1 Fuel thermal behaviour modelling approaches

As aircraft fuel tanks can be large and dynamic heat sinks, it is often important to understand their thermal behaviour from an overall aircraft mission perspective. This section provides a brief literature review of thermal modelling approaches for aircraft fuel tanks. Approaches can be classified by the relevant modelling philosophy employed, the main types of which are summarised in Table 5.

Table 5: Fuel tank thermal modelling approaches (adapted from Ref. [14]).

Approach	Governing relationship	References
Bulk one-dimensional steady state models	$\sum \dot{Q}_{loss} + \frac{\Delta T}{R} = 0$	[145]–[147]
Bulk one-dimensional transient models	$\rho C_p V \frac{dT}{dt} = \sum \dot{Q}_{loss}$	[14], [82], [106], [133], [134], [147]–[149]

Finite volume one-dimensional transient models	$\left(\rho C_p V \frac{dT}{dt}\right)_i = \left(\sum \dot{Q}_{loss}\right)_{i+1,i-1}$	[150]
Three-dimensional heat diffusion CFD models	$k \frac{d^2 T}{d^2(x, y, z)} + \dot{Q}_{loss} = \rho C_p \frac{dT}{dt}$	[151]

Using simple one-dimensional equilibrium and transient models (lumped parameter methods) for modelling fuel thermal behaviour can enable reasonably swift thermal simulation of fuel tank networks. These methods involve assigning ‘thermal nodes’ to represent the thermal characteristics of fuel tank volumes (i.e., bulk fuel and ullage) and surfaces (for the tank walls). For the equilibrium case, the upper and lower wall nodes have the same temperature as the external atmosphere. With these as boundary conditions and, with appropriate initial conditions for all the nodes, the node parameters can be calculated iteratively using one-dimensional heat transfer equations for conduction, convection, and radiation. This approach can be adapted to transient cases by relaxing the assumption of equilibrium temperature at the walls.

A more detailed tank discretization than in one-dimensional methods is presented in [150]. In that study, the tanks are considered trapezoidal volumes, which simplify estimating the ullage and fuel surface areas for different tank fill states. The difference with one-dimensional methods is the discretization of the volume into volume elements, which are solved by an energy balance. This enables estimating temperature distributions per element, rather than per tank volume.

In Ref. [151], a detailed computational fluid dynamics simulation of a wing fuel tank, which included a leading edge bleed air duct, was conducted. A mesh was created for the case study structure and tank, after which a temperature distribution was predicted in the tanks for when hot air flows through the bleed air duct in the D-nose of the wing.

6.2.2 Improving fuel thermal stability

Fuel thermal stability refers here to the ability of (hydrocarbon-based) fuel to withstand reacting to oxygen molecules dissolved within it when being heated. Such chemical reactions form soluble and insoluble oxidation products [152]. The insoluble products form deposits that can cause fouling and clog fuel and engine system components. This process is known as ‘coke formation’ or ‘coking’. It is a complex process, involving both physical and chemical processes [153]. Coking imposes a limit on the temperature that fuel can be heated to, as above certain temperatures, the rate of coking becomes unacceptable. Therefore, much effort is being expended to increase the thermal stability of fuels (i.e., to increase the temperature at which coking starts to become problematic). Approaches usually involve injecting chemical additives into the fuels, or employing deoxygenation systems that reduce the amount of dissolved oxygen in the fuel [109]. These are described in the subsections that follow.

Additives

Antioxidant or dispersive additives can increase the temperature at which fuels become thermally unstable due to coking. Antioxidants reduce oxidation, whereas dispersants reduce deposition of the oxidation products. One major advantage of additives is that they can increase the heat sink capacity of fuels without adding additional equipment on board [109].

One endeavour that was devoted to studying the use of additives to improve the military jet fuel JP-8 was the United States Air Force JP-8+100 programme [152]. The goal of this programme was to increase the thermal stability limit of JP-8 by 100 °F (55 °C), through the use of appropriate additives [152]. This corresponds to an increase of the nozzle bulk fuel temperature of 163 °C to 218 °C [152]. Ho et al. [131] found that the use of JP-8+100 enabled an increase in cooling capacity

of the thermal management system of between 26% to 40% for a Boeing F/A-18 and has growth potential.

Dooley et al. [109] state that the use of additives for aviation applications are at technology readiness level 8 and may enable a possible twofold growth in heat sink capacity.

Deoxygenation systems

The function of deoxygenation systems is to reduce the number of oxygen molecules in the fuel and thereby reduce coking, which in turn will increase the temperature to which the fuel could be heated in a given system. Such systems are still in the exploratory phase and Dooley et al. [109] places their technology readiness level at between 3 and 4 and predict that they could enable an up to twofold growth in heat sink capacity.

Dooley et al. [109] provided an overview of three different promising deoxygenation technologies –advanced sparging methods, membrane-based deoxygenation, and catalytic deoxygenation. The advanced sparging method involves bringing the fuel in contact with an inert gas inside a reactor called a contactor. The contactor turns the fuel with dissolved oxygen into a gas-fluid mixture from which the oxygen-rich gas can be removed by a separator. In a membrane-based system, the oxygen diffuses from the fuel into an inert gas through a filter, leaving deoxygenated fuel behind. Finally, a catalytic system, which functions in the same manner as a catalytic converter, performs a chemical reaction, in which the oxygen is combined with another element to form a product that could be filtered out. An example is the use of hydrogen, in which case the product is water.

Deoxygenation systems appear promising in reducing coking, thereby allowing higher fuel temperatures, and subsequent increased thermal endurance. However, they will inexorably add additional mass and complexity [109].

6.2.3 Reducing fuel system component heat loads

Reducing the heat loads from the fuel system itself enables more heat from other systems to be rejected to the fuel. Such heat loads from the fuel system often arise from the fuel pumps and there exists some research that focuses on determining the effects of different current and future fuel pumps on the thermal management capability of the fuel [128], [132]. Donovan et al [128], for example, has shown that a variable displacement pump could provide a substantially better thermal margin (difference between fuel temperature and maximum allowable fuel temperature) for the fuel than a centrifugal pump in a study on thermal management for a tactical fighter. Oppenheimer et al. [5] have also shown how lowering the capacity of the primary fuel pump in a two-pump system on a fighter aircraft can significantly reduce thermal energy transferred to fuel.

6.2.4 Fuel system architectures and control approaches

Much research on using fuel for thermal management focuses on investigating different fuel system architectures and control strategies. Here, architecture refers to the arrangement of the fuel tanks, along with the topology and sequence of circulation/recirculation of fuel amongst the tanks, the heat sources, heat sinks, and the combustion chamber.

Alyanak and Allison [135] compared the thermal management capabilities of four simple fuel TMS architectures for a supercruise aircraft concept (Figure 10). These were a simple feed-only architecture, recirculation to the tanks, recirculation direct into a separate feed tank, and recirculation into the main tanks, but still with a separate feed tank. It was shown that recirculation directly into a separate smaller feed tank is not beneficial, whereas recirculation into larger tanks that are not temperature constrained is superior.

In a series of related studies on the relationship between thermal endurance, fuel tank topology, and fuel thermal management system control [2], [3], [7], [8], [136]–[138], [140], [141], it was shown that the thermal endurance of a notional fighter aircraft could be extended by using a designated, smaller tank for recirculation along with another as reservoir (Figure 11), rather than recirculating to one single tank array. Thermal endurance could also be increased by making the topology of the fuel flow controllable, especially with temperature and recirculation tank level regulation. Employing dynamic multi-tank topology robust control strategies (see Refs. [2], [3]), rather than either single or dual tank configurations exclusively, provide further benefits. It was shown in Ref. [7] that predictive control could adequately handle the effects of fluid transport delays in the fuel system network. The techniques in these studies were used to devise mission planning and ‘online’ (real time) thermal endurance prediction capabilities in Refs. [140], [141]. This is useful, as, for example, such techniques could show a pilot in real time how much thermal endurance is left.

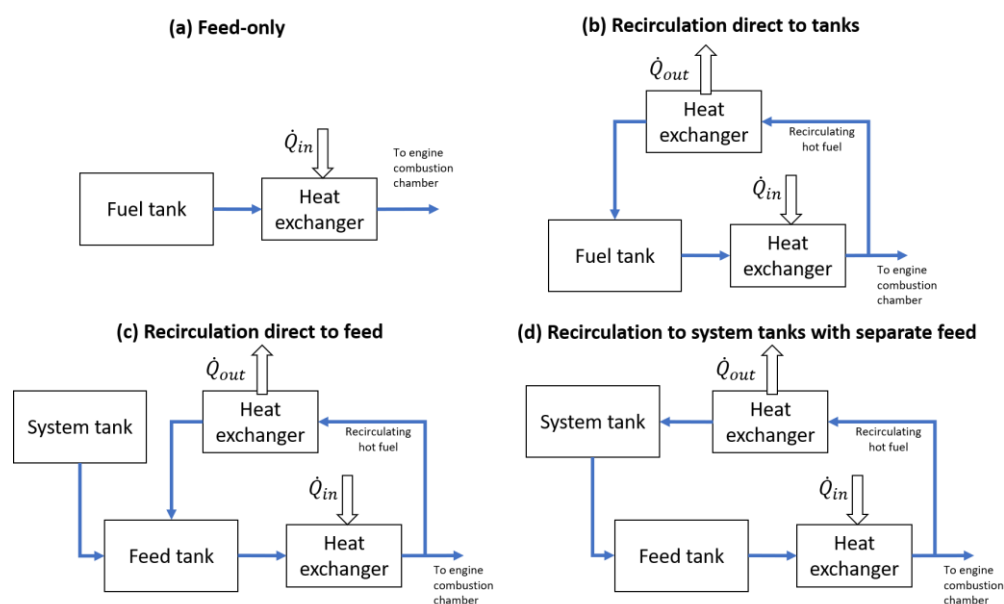

Figure 10: Fuel thermal management system architectures studied by Alyanak and Allison [135] (adapted).

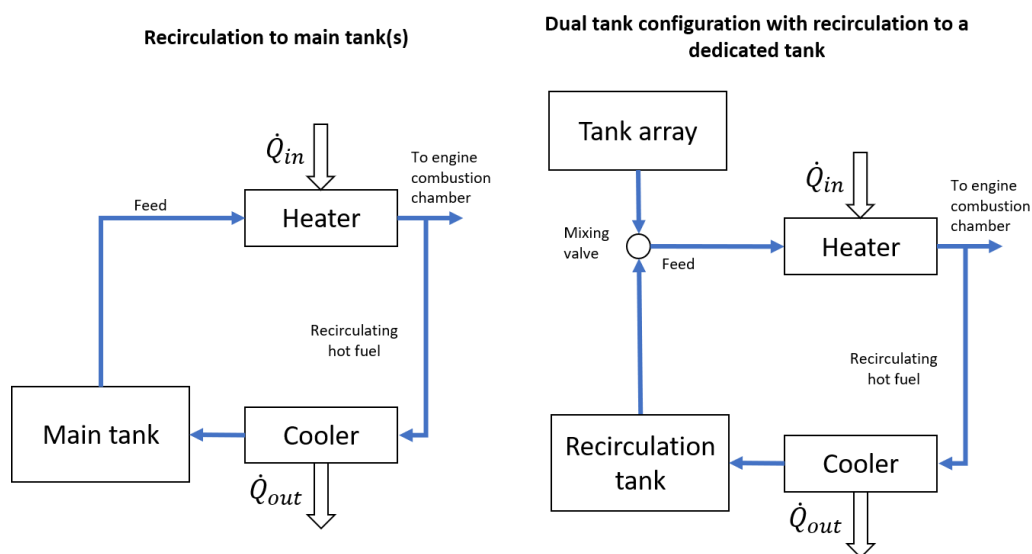

Figure 11: Fuel tank topologies for a notional fighter aircraft studied in Refs. [140], [141] (adapted). The configuration on the right (recirculation to a dedicated tank) enabled a significant improvement in thermal endurance.

Kellermann et al. [144] performed a study for assessing the feasibility of using fuel as a heat sink on hybrid electric transport aircraft. Two concepts were considered: one with integrated fuel heat exchangers in the top and bottom of the wing surface and one with normal heat exchangers placed inside the existing fuel tanks. The integrated wing heat exchanger was superior, providing a fuel burn improvement of up to 0.6% compared with a ram air cooling system.

In other studies, the integration of the fuel system with other thermal management systems were investigated. For example, Seki et al. [38] proposed an air/fuel integrated thermal management system for civil aircraft, which employs a vapour cycle system as the refrigeration unit of the environmental control system.

Most of the studies on fuel thermal management system architectures and control are devoted to military aircraft. There is a need for similar studies for the large multi-tank topologies of civil aircraft. The research on military aircraft could be used as a starting point, but certifiability will be a major consideration for civil applications.

6.2.5 Flammability exposure and ignition prevention

Increasing the reliance on fuel as a heat sink, especially for civil aircraft, will inevitably lead to major concerns regarding flammability. Paragraph 25.981 in Part 25 of the FAA Airworthiness Standards for transport category airplanes defines regulatory requirements for ignition source prevention and flammability reduction to prevent a fuel tank explosion. CS-25.981 is the European Aviation Safety Agency equivalent. These requirements broadly state that no ignition source may be present in the fuel tanks where catastrophic failure could occur due to ignition of fuel or vapours, and that the fuel tanks must meet limited and controlled flammability exposure criteria.

Because of difficulty with accurate prediction of flammability and eliminating flammable vapours, it is normally assumed that a flammable fuel air mixture may always exist in the tanks [154]. It is therefore required that any energy input to the tank (such as which may originate from electrical wiring) be limited.

Thus, if heat is rejected to fuel in the tanks or to fuel which returns to the tanks, it is important to remove the hazard of electrostatic discharge, which contributes to flammability and can be a source of ignition. This can be done by 1) limiting mist formation, fuel sloshing, and spraying of fuel in the fuel tanks 2) ensuring recirculated fuel is introduced at or near the bottom of the tank, 3) ensuring recirculated fuel is directed onto a grounded conducting surface, and 4) distributing low-velocity recirculated fuel around the tank with the use of piccolo tubes.

The temperature and pressure in the fuel tank, which varies with flight altitude, speed, and range, determine when the fuel tank is flammable. The tank is considered flammable when the oxygen concentration in the vapour (ullage) exceeds a specific limit and the temperature is within a certain range of values. Thus, for unpressurised tanks there is a lower and upper flammability limit (LFL and UFL, respectively) at different levels of altitude. Currently Jet-A and Jet-A1 fuels are predominantly used in commercial aviation, and their LFL and UFL are defined by EASA CS-25 (Book 1, N25.3). The LFL temperature is defined as the fuel flash point temperature at sea level (38 °C for Jet A-1), minus 5.5 °C and decreases with altitude at a rate of 0.55 °C per 808 ft. The UFL is the flash point temperature at sea level, plus 19.5 °C and decreases at a rate of 0.55 °C per 512 ft of altitude gained. If the bulk fuel/ullage temperature inside a tank is within the LFL and UFL limits, that tank is considered flammable.

A significant length of time spent by fuel/ullage within the flammability zone will compromise compliance against flammability reduction regulation [154], [155]. This is conventionally addressed

with an inerting system [155], which significantly reduces oxygen concentration inside the tank, by continuously replacing oxygen-rich ullage with either nitrogen or carbon dioxide enriched air. The air, before it is conditioned, is typically bled from the engine, which has a detrimental effect on engine SFC.

Alternative methods of regulatory compliance include explosion suppression means, such as using appropriate foams, such as polyurethane foams, to fill the tank ullage space and a strengthened structure that can withstand the effects of an explosion [156].

The United States Federal Aviation Authority has prescribed a dedicated flammability analysis tool [129] (Figure 12). It takes as input key thermal parameters that relate to the fuel management system, including the fuel burn sequence per tank architecture and mission, as well as tank heat transfer characteristics. An equilibrium temperature differential, reached between the bulk fuel temperature and the ambient, given sufficient time, needs to be provided with and without systems/engines running. Exponential time constants describe how fuel in the tank heats or cools in response to heat inputs during a time step. Their values need to be established by a thermodynamic tank model and/or flight tests. Therefore, any defined thermal model of the fuel tank has ultimately the task to produce these required time constants to be able to complete the FAA approved flammability analysis process.

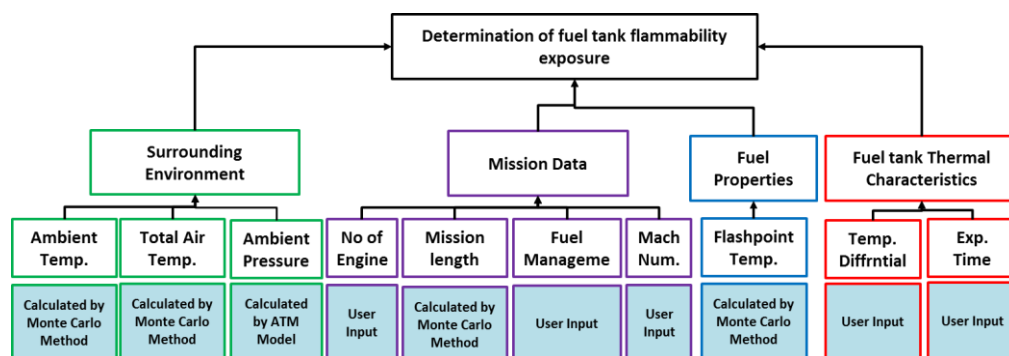

Figure 12: Overview of the main analysis components and their associated inputs for the FAA tank flammability assessment tool [129].

6.3 Aircraft structure

The aircraft structure itself may sometimes be utilized as a terminal heat sink for various airframe or engine system heat sources. The material properties of structural components play a major role in their ability to conduct and retain heat. Aluminium alloys and carbon-fibre reinforced polymer (CFRP) composite materials have significant differences in terms of thermal conductivity and capacitance, which requires a review of traditional approaches for heat rejection through skin surfaces. Well-studied example are the wing and centre fuselage fuel tanks, and the need for additional thermal assessments of composite integral fuel tanks [157]. In addition, new structural failure cases, due to thermally induced buckling are needed [158], [159]. Effort is also underway to develop so-called thermally integrated structures to increase the thermal conductivity of composite materials [109], [160].

6.4 Thermal storage and conversion heat sinks

A beneficial manner in which waste heat could be used is if it could be stored or converted into energy of a more useful form, such as work. Several such means (old and new) exist, including:

- *Energy conversion using thermodynamic cycles.* Although not novel per se, converting waste heat to useful mechanical power has not seen significant application yet on aircraft. Rankine and organic Rankine cycles could be investigated as means to convert waste heat to useful shaft power, such as described in Ref. [161]. The heat sources would have to be at relatively high temperatures for such an approach to be feasible. Another possibility is to use heat to drive a refrigeration process, which could be used to provide cooling where needed. This can be done with devices known as absorption refrigerators, which use the vapour absorption cycle. Despite their promise, the advantages of these thermodynamic cycles need to be carefully traded off with their potential pitfalls, namely: additional complexity, mass, cost, and possible safety, reliability, and maintainability implications. These cycles are covered in more detail in Section 7.2.
- *Thermal storage: phase change materials (PCMs)* [162]. These are substances that have large heats of fusion. They can therefore absorb large amounts of heat without significant changes in temperature and volume. PCMs may be useful for absorbing intermittent peak loads, and thereby allowing for smaller overall thermal management systems. For aircraft applications, it needs to be investigated if the added mass and volume would negate the potential benefits of PCMs. Several patents already exist for employing PCMs in aircraft (see e.g. Refs. [163], [164]). A small number of academic studies have considered their use as well. These often focus on the use of PCMs for energy harvesting purposes to power sensors (e.g. Refs. [165]–[167]), such as those employed for health monitoring. However, PCMs are also being increasingly being considered for larger scale thermal management applications, such as providing cooling for electrical machines in electrified propulsion aircraft [168]. Affonso et al. [102] place the TRL for PCMs in aviation at between 4 to 6, as research in this area is picking up pace.
- *Thermoelectric heat sinks* [169]. These are devices that generate electricity from heat (through the ‘Seebeck’ effect) or absorb heat when a voltage is applied across it (through the ‘Peltier’ effect). The reader is referred to Ref. [170] for a short overview of aircraft applications that have been studied. According to Ref. [170], a challenge with thermoelectric installations on aircraft is that, even with the current state of the art, power densities remain low (0.05 kW/kg vs a required 0.5 kg/kW). However, the efficiencies of these materials are improving, and different types of installation architectures may improve the power density to such an extent that they become more attractive for larger scale use. Indeed, Ziolkowski et al. [171] has shown that when placing thermoelectric generators between the hot core stream and cold bypass flow of a gas turbine engine, a feasible design range can be obtained, with a beneficial effect on aircraft specific fuel consumption. The TRL for the implementation of thermoelectric heat sinks in aircraft has been placed at between 3 and 4 [102].
- *Caloric materials* [172], [173]. Caloric materials are substances that undergo reversible heat generation or absorption when a driving field (mechanical, magnetic, or electric) is applied over them. These may be useful for cooling electronic devices. An example of an idea employing caloric materials is to use the magnetic fields of the electric machines in hybrid electric aircraft for cooling, via materials exhibiting the ‘magnetocaloric’ phenomenon [102]. These are at low TRL (<3) [102].
- *Thermoacoustic heat engines.* Thermoacoustic generators are devices that create sound waves (work) from temperature differences in a gas. The converse of this is thermoacoustic refrigerators, which pump thermal energy using sound waves as input. An aircraft example where both these principles are employed for thermal management is given in Dyson et al. [174] and is described in more detail in Section 8.1.6.

7. Thermal transport

As discussed in Section 3, thermal transport, in the context of this paper, refers to the transport of thermal energy over some distance from the heat source to the aircraft terminal heat sinks. This is contrary to the situations where the terminal sink is in direct contact, or in very close proximity, to the heat source. A thermal transport system therefore consists of the components, fluids, sensors, and control means that enable the waste heat to be moved from the source to the terminal sinks. It is a very large subject and only the most relevant and recent developments will be covered here. Additionally, the focus is mainly on systems rather than on individual components and most of the text that follows will reflect this. However, brief descriptions on developments in some important thermal transport components, such as heat exchangers, are indeed provided.

7.1 Important thermal transport components

As described before, thermal transport components include heat exchangers, heat pipes, valves, pumps, piping/ducting, throttles, compressors, turbines, fans, sensors, and control equipment, and so forth. These should be as lightweight and efficient as possible to minimise impact on the performance of the aircraft. Additionally, there are also the working fluids, which include gases and liquids. These components/fluids are ubiquitous in many industries and therefore fall somewhat beyond the scope of this paper. Only heat exchangers, passive thermal transport devices (such as heat pipes) and some important transport fluids are therefore covered here, and only from an aeronautics perspective.

7.1.1 Heat exchangers

Heat exchangers are the workhorses of thermal management systems. They are devices that enable heat to be transferred from one fluid to another, without the two fluids mixing. They are extremely common, and many types are present on most aircraft. Common aeronautical examples include fuel- and air-oil heat exchangers (FOHEs and AOHEs – see Sections 5.1.1 and 6.2), which cool engine and generator lubrication oil; the air-air heat exchangers in the air-cycle machines of environmental control systems; other heat exchangers that use ram air to cool some fluid carrying heat from airframe systems; hydraulic heat exchangers submerged in fuel tanks to cool hydraulic oil; and so forth.

Despite their maturity and ubiquity in engineering systems, there is still much research ongoing to improve heat exchanger performance. This is especially true in aerospace, where the focus is particularly on reducing weight, increasing compactness and effectiveness, and improving manufacturing techniques [41], [110]. There is also much work being undertaken to enable the production of heat exchangers with special shapes that enable them to fit better into tight and irregularly shaped spaces. These efforts are driven by the recognition of the impending thermal management challenges looming for novel aircraft in the near future. A selection of current research topics in heat exchangers for aircraft are discussed in the subsections that follow.

New heat exchanger geometries

Much research is devoted to developing heat exchangers that have custom geometries enabling snug fits in tight volumes or around other components. This is done to limit the negative effects on performance, by limiting pressure drops, as well as to ensure better use of volume.

For example, in Ryemill et al. [175], the development of ‘panel’ type heat exchangers are discussed, which are rounded heat exchangers that can fit snugly around engine panels. These are intended to be air-oil heat exchangers for ultra-high bypass ratio geared turbofans, and their panel shape

limits losses in the bypass duct. Meggitt PLC are developing specially shaped air-oil heat exchangers that are to be embedded in the engine core casing and receive cooling air from the fan duct (Figure 13). Other examples of irregularly shaped heat exchangers include the developments in annular fan duct air-air heat exchangers for pre-coolers of bleed air systems. According to Kasim et al. [110], by using traditional fins in such an unconventional volume space, Boeing Research and Technology achieved a heat exchanger weight reduction of 2% and a volume reduction of 6%, compared with conventional designs.

Such irregular heat exchanger geometries are increasingly made possible by new manufacturing techniques, especially additive manufacturing (see the ‘new manufacturing techniques’ section that follows).

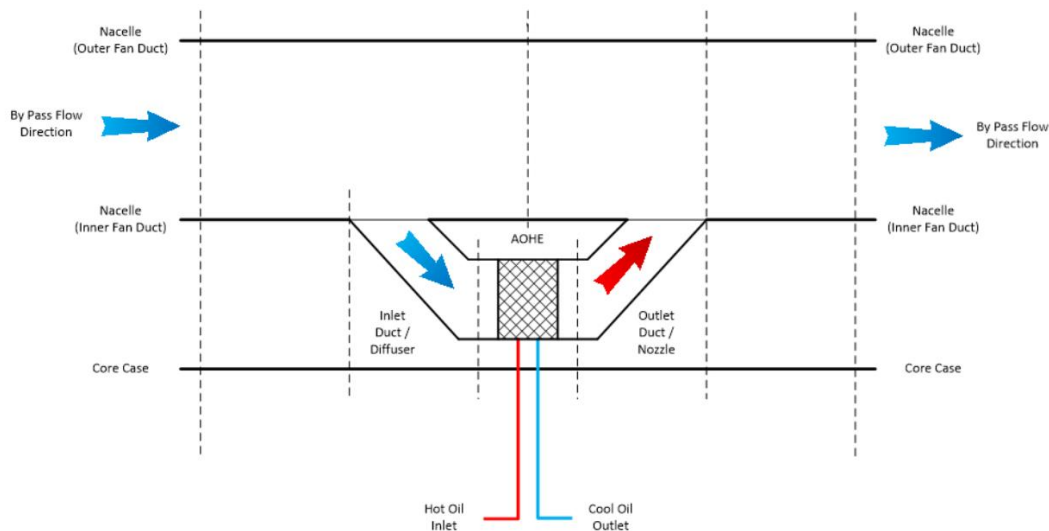

Figure 13: Embedded air-oil mini system with a heat exchanger and inlet and outlet ducts in turbofan bypass stream (image courtesy of Meggitt PLC).

Increasing heat transfer capability

Research is also being devoted to increasing the heat transfer capability of heat exchangers. For example, the development of high surface density structure technologies inspired by nature (i.e., developed using biomimetic engineering), that would improve heat transfer, is discussed in Ref. [175]. Kasim et al. [110] describe possible enhanced heat transfer and lower pressure drops for compact heat exchangers with novel heat transfer surfaces geometries. These include offset-strip fins with new geometry variations, such as longer offset lengths, as well as novel combinations of wavy fin wave amplitudes and wavelengths [110]. It is vital that the fluid dynamics and heat transfer behaviour of such new geometries be characterised by researchers, to enable the design space to be expanded, which will ensure that these could be exploited [110].

The drive to increase heat transfer per volume has led to the recent emergence of ‘microchannel’ heat exchangers [176]. Microchannel heat exchangers are characterised by small fin spacing-to-height aspect ratios and small hydraulic diameter flow passages (between 200 μm and 700 μm) [41]. These small hydraulic diameters increase heat transfer surface area substantially, which, along with the small fin aspect ratios, enable larger Nusselt numbers and subsequently enhances heat transfer per unit volume [41]. Microchannel heat exchangers are increasingly being investigated for aeronautical applications (see for example [41], [176]–[178]), and could, for example, be used for air-to-air (esp. engine-bleed), air-to-liquid fuel coolers, and liquid-to-liquid engine oil coolers [176], amongst others.

Skin/surface heat exchangers

Skin heat exchangers are heat exchangers where the cold side is the ambient atmospheric air, and the hot side is a fluid carrying waste heat away from aircraft heat sources. The heat transfer surface itself is part of the airframe structure, but cooling can be enhanced with fins or other means. Developments in skin heat exchangers technology were covered in more detail in Section 6.1.3.

New manufacturing techniques

Many of the heat exchanger enhancements described in the previous subsections were only made possible thanks to new manufacturing processes. One specific set of techniques that has enabled significant advances in aeronautical heat exchanger design is additive manufacturing (see, for example, Refs. [110], [179]). In particular, these techniques have enabled many new heat exchanger geometries and the associated advantages of these, as described previously. They have also enabled new fin geometries, such as S-channel, C-channel fins, and oblique fins [110].

For manufacturing microchannel heat exchangers, enabling techniques include [41]: 'microelectromechanical' (MEM), 'Lithographie Galvanoformung Abformung' (LIGA), hollow polymer, and precision machining, wire electrical discharge machining (EDM), lamination or printed circuit fabrication, laser ablation, gear rolling, and folded fin techniques.

Manufacturability is often the limiting factor in what can be achieved with advanced heat exchangers and many research challenges remain. These include, amongst others, the need for improved techniques for fabricating different materials (apart from the commonly used aluminium, these could include stainless steel, titanium, and conductive polymer composite materials [110]); improving brazing processes [41], and addressing the pitfalls of additive layer manufacturing, such as surface roughness and sealing issues [110].

Cold plates

Cold plates are devices very similar to heat exchangers. However, they only have one fluid, which is on the 'cold side', whereas the 'hot side' is the external surface of the cold plate itself, onto which a heat source such as a circuit board is placed directly. Cold plates are widely used in liquid cooling applications of avionics and power electronics, where the liquid used is often a dielectric, such as polyalphaolefin, or a water-glycol mixture. The fin geometries employed on the liquid side of cold plates are usually similar to those employed in heat exchangers (especially plate-fin types) and the design and manufacturing challenges are therefore very similar to those of heat exchangers.

Design and development methods

Another area of heat exchanger research that frequently sees new development is that of design and development methods. For example, Ryemill and Min [175] presented a novel heat exchanger design methodology for heat exchangers on the future Rolls-Royce Ultrafan engine. This methodology enables the ranking of heat exchangers, based on updated performance correlation databases and incorporating the effectiveness-NTU method. This methodology, and its integration with other Rolls-Royce tools and procedures, enables more effective preliminary design of high-efficiency heat exchangers. Kasim et al. [110] presented a design using industry standard heat exchanger analysis software and accounting for novel fin geometries and the requirements of additive or traditional manufacturing techniques. Design techniques have also been developed for microchannel heat exchangers, such as presented in and [177], [178]. Future work should involve improving on these techniques, especially by allowing more fin and overall geometries to be considered in a computationally inexpensive manner. More methods that would link the heat exchanger design process with the larger thermal transport system design (as explored in Ref.

[180]) are also desirable, as such techniques could enable better integrated thermal management system performance.

7.1.2 Passive heat transport components

Passive heat transport components are devices such as heat pipes, thermosyphons, and vapour chambers. They have several advantages, such as not having any moving parts, low maintenance, and not needing any input energy [102]. They are ideal for 'federalised', local cooling applications, since they do not need to be connected to, for example, the aircraft fuel system, hydraulics, or liquid cooling loops. However, they could be incorporated into other cooling systems [102]. Indeed, much opportunity exists for exploring their use incorporated into larger aircraft thermal management systems.

Heat pipes are closed loop, sealed systems, where the pipe element contains a porous wick saturated with a working fluid and a hollow centre. As heat is introduced at one end of the pipe, the fluid vaporises and the vapour travels to and along the hollow centre section of the pipe. At the cold end, the vapour condenses, with the liquid travelling back to the wick. Capillary action in the wick moves the fluid back towards the hot side. In aeronautical systems, heat pipes have found applications in avionics cooling (see for example Refs. [181], [182]), electromechanical actuator cooling [89], and anti-/de-icing systems [182].

In order to overcome some of the limitations of heat pipe design, such as the dependence of performance on gravity orientation and small transport distances (<3 m), 'loop heat pipes' can be utilised. For loop heat pipes, experimental and computational work have demonstrated stable heat transfer over distances of up to 10 m with a heat load of 160 W [183]. Such long-distance loop heat pipes are still an active topic of research. Other work with aerospace related applications points towards higher performance, with heat loads of 500 W to 5,000 W [184].

Thermosyphons are similar to heat pipes, but do not have wicks. Instead, they rely on gravity and natural convection to induce the movement of the working fluid. As with heat pipes, for aeronautical applications, thermosyphons seem especially suitable for cooling of electrical devices (see, for example, Ref. [185], where they are proposed to be used for cooling in-flight entertainments systems and Ref. [89], where they are proposed for cooling electromechanical actuators, along with heat pipes). However, other applications should be explored as well.

Vapour chambers are similar to heat pipes but enable heat transfer in two or three dimensions [186]. They are therefore favoured over heat pipes for high heat flux applications [186].

7.1.3 Transport/working fluids

Transport/working fluids are any gases or liquids that acquire heat via convection at the heat source location and rejects it at the heat sink. These fluids could also undergo phase changes or other thermodynamic processes, with the aim of enhancing heat acquisition/rejection.

Air, because of its availability from the surrounding atmosphere, is the most common fluid employed for thermal management on aircraft (see Section 6.1). Using air for this purpose is simple, does not involve any harmful chemicals, and air can serve multiple other functions (e.g., in the air cycle machine of the environmental control system, it acts both as the refrigerant and the product of the cooling process).

However, liquids provide a significantly higher specific heat capacity than air (and other gases), which, combined with the much greater density of liquids, results in smaller system components and transfer pipes for liquid cooling systems. This reduces volume requirements, but the overall

system mass may be greater due to the stored mass of the liquid working fluid. Lubrication oils and fuel are the most common liquid coolants used on aircraft.

With the new challenges being faced regarding thermal management, many types of liquid cooling and refrigerants have been introduced on aircraft. These include, inter alia, dielectric fluids, such as polyalphaolefins (often used for electronics), thermo oils, propylene and ethylene glycol-water mixtures [102], as well as refrigerants, such as those in the R-series, and carbon dioxide, for potential use in supercritical cycles [187], [188].

Research on fluids for thermal management involve several topics, such as increasing cooling effectiveness via different mechanisms [21], [189], additives for enhancing thermal properties [190] (see also Section 6.2.2 for additives in fuel), specialised nanofluids for thermal management (especially for batteries) [189], [191], [192], and so forth. Important challenges that need to be addressed revolve around managing the safety, complexity, maintainability, reliability, and environmental aspects of using non-traditional and novel thermal management fluids in aviation.

7.2 Cooling loops and thermodynamic cycles

Cooling loops and thermodynamic cycles refer to the sequence of processes that the working fluids undergo to perform their thermal transport and transfer roles. These processes include the heat transfer itself (which could be accompanied by phase changes), pumping, compression, throttling and expansion, absorption, and so forth. These cycles could involve multiples of these processes and be open- or closed-loop. In response to the growing challenge of providing adequate thermal management for aircraft, the use of traditional, non-traditional (in aviation), and novel cycles is receiving increasing attention in the literature. The focus is on devising systems that are effective, but also of low mass, are of low cost, safe, and reliable, and that will have a low impact on overall aircraft performance.

7.2.1 Simple cooling loops

The simplest of these cycles are those that are open loop and where there is no significant phase change. Examples include air cooling systems where the heated air is expelled from the aircraft, or engine feed fuel that is passed through the fuel-oil heat exchangers to cool engine oil before reaching the combustion chamber. Other simple cooling loops are closed or semi-closed loop cycles that only involve pumping/blowing of a liquid/gas, as well as heat acquisition at the source and heat rejection at the sink. The technology readiness levels for air and liquid cooling loops in aviation are high [102], with liquid cooling seeing increasing adoption in military and civil aviation (a recent example being the Boeing 787).

In these simple cooling loops, the heat source is at a higher temperature than the sink, and the function of the cycle is simply to transport the thermal energy between these two points. When the heat source is at a lower temperature than the sink, or if it is required to obtain some useful work from the cycle, more complex thermodynamic cycles, such as refrigeration ('thermal lift') or power cycles, are usually required.

7.2.2 Refrigeration cycles

On aircraft, because of their use in environmental control systems, the most common refrigeration cycle is the air-standard refrigeration cycle (also called the reverse Brayton cycle) and its many variations. Developments in environmental control systems are covered in more detail in Section 8.4.

Although not that common on aircraft, the vapour compression cycle/system (VCC or VCS) is a very widely used refrigeration cycle in general cooling systems. Although being significantly more efficient than air cycles, VCCs are limited in that they can only operate in narrow temperature ranges, have high mass, and have low maximum allowable operating temperatures. Despite this, they have a high TRL in aviation and have seen applications on both military (especially fighters) and civil (for example, the Embraer Phenom family of aircraft) aircraft [102]. Moreover, more recently, many studies have focused on or involved vapour compression systems, and a selection of these is summarised in Table 6.

Table 6: Studies on vapour compression systems (VCSs) for thermal management on aircraft.

Study(ies)	Type of aircraft	Main purpose of the study	Main heat loads	Main heat sinks	Main conclusions
Homitz et al. [86], [193] (2008, 2010)	Advanced military aircraft.	To propose a vapour-compression (using R-134a) thermal bus (VCTB) as a new aircraft thermal management architecture.	Generic (a small set of representative low temperature thermal loads were used)	Ram air and fuel.	It is concluded that the main advantages of VCTB are: <ul style="list-style-type: none"> • Ability to deal with high-power electronic systems • Reduced heat exchanger volume, weight, and mass flow requirements • Reliable cooling capacity as changes in heat sink temperature occur • Operate reliably with both transient thermal loading conditions and transient environmental conditions that can be expected during military airborne combat operations.
Byrd et al. [194] (2011)	High-performance military aircraft (assumed).	To develop and demonstrate an optimum-seeking control scheme to be applied to dynamic multi-evaporator VCS targeted towards advanced aircraft TMS.	Experimental heaters representative of expected thermal loads were used.	Fuel and air.	A Two-Phase Thermal Energy Management System rig was developed, and the configuration was capable of running in a very stable manner.
Morioka et al. [39] (2014)	More-electric 180-passenger single aisle aircraft.	To propose an 'autonomous air-cooled' thermal management system, which encompasses a VCS, a forced air-cooling system for power electronics, and an efficient fuel system for a more electric engine.	Several system components located around the aircraft.	Atmospheric air and fuel.	The proposed TMS is efficient and eliminates the need for liquid cooling systems for the power electronics. Issues that remain are the added weight, safety, and reliability.
Emo et al. [195] and Michalak et al. [196] (2014)	High-performance military aircraft.	To develop and test VCS (with R-134a) control schemes for cooling advanced aircraft waste heat loads. The testing was done using the US Air Force Research Laboratory's 'Vapor Cycle System Research Facility'.	Experimental heaters representative of expected thermal loads were used.	Chillers were used to simulate heat sinks.	In Ref. [195], it was shown that the active charge management system proposed provided efficiency, accuracy, and operability benefits, but would add weight and complexity. In Ref. [196], it was shown that a cycle-based control approach, in which both the high- and low-side pressures are directly controlled, outperformed a conventional superheat and capacity control approach in the metrics considered.
Pollock et al. [197] (2016) See also Table 10.	Generic (assumed high-performance military aircraft).	To investigate the use of model predictive control with VCS (with R-134a) for aircraft thermal management.	Generic (heat load transient disturbances of up to 15 kW).	Heat from VCS is rejected to a water-glycol mixture.	The proposed control strategy was shown to have encouraging improvements over conventional PI-based control.

Zhao et al. [198] (2020)	Helicopter.	To investigate an antifreeze and VCS TMS for a helicopter. A control strategy was also proposed.	High-power electronic equipment (up to 15 kW).	Waste heat is collected by an antifreeze liquid cooling loop. The VCS (with R-134a) transports the heat and rejects it to ram air.	The results showed that, in both cold and hot extreme weather conditions, the developed control strategy ensured stability of the TMS.
--------------------------	-------------	--	--	--	--

Other refrigeration concepts are absorption refrigerators (employing the vapour absorption cycle) and thermoacoustic refrigerators. Absorption refrigerators are devices that use heat to power the refrigeration process, rather than shaft power (as in vapour compression cycles), and follow the vapour absorption cycle [199]. Affonso et al. [102] suggest that these may be used for precooling of the TMS (for hybrid-electric aircraft), with the required heat originating from the gas turbine. Challenges, such as harmful components and low efficiency remain, however, and the TRL for absorption refrigerators in aviation are placed at between 4 to 5 [102]. Thermoacoustic refrigerators are devices that use sound waves to perform refrigeration. The reader is referred to Section 8.1.6 for an example of how these have been proposed to be used on aircraft.

The transcritical cycle, using carbon dioxide [161], [187], [188] as the working fluid, is another promising refrigeration cycle that could see application on aircraft in the future. Major advantages of using carbon dioxide over traditional synthetic refrigerants include its availability, low cost, and sustainability.

7.2.3 Cycles producing useful work

As alluded to in Section 6.4, waste heat could also be employed to generate useful work. This could be done with a Rankine cycle (an example for aircraft is proposed in Payne et al. [200]), thermoacoustic heat engines (where heat is employed to generate sound waves, i.e., the opposite of thermoacoustic refrigerators – see Section 8.1.6 for an example), and thermionic generators (described for aviation in Ref. [102]). Organic Rankine cycles, employing supercritical fluids could also be considered. In all these cases, the temperature of the relevant heat source must be high.

7.3 Increasing integration

Thermal transport systems on aircraft are already quite complex. This can be appreciated when looking at Figure 14, which shows a diagram that combines the thermal management system architectures of several civil transport aircraft into one. As can be seen, there are many possible elements involved and there is much interaction across different systems, which would affect aircraft level performance. Integration, if designed appropriately, could have many advantages, such as:

- Reduction of the drag and power offtakes elicited by the TMS, because of more intelligent use of terminal heat sinks.
- Lower mass, because of the introduction of multifunctional components/subsystems.
- Use of waste heat for purposes where heat is needed (such as fuel being heated before combustion, while cooling the engine oil), which promotes optimal energy management and reduces the negative effects on efficiency.
- Better maintainability, because of fewer components.

The main purpose of integration is therefore to enable sufficient thermal management at minimal negative impact to overall aircraft efficiency and operation. This purpose is increasingly driving research into more integrated approaches to thermal management, with many of the references presented in Section 8 following some form of expanded integration. Indeed, this focus on

increased integration has recently led to the emergence of combined ‘power and thermal management systems’ (PTMSs), in which the functions of thermal management and the provision of secondary power are combined into a single system. This enables optimal energy management across the entire mission of the aircraft, with low mass and power offtakes. PTMSs are described in more detail in Section 8.5.

However, despite the benefits, there are also potentially significant challenges related to developing and operating more integrated thermal transport systems. These include:

- *Complexity.* Integrated systems are usually more complex than federalised systems, with designers and operators needing to keep track of the many potential interrelationships between the different elements of the system, as well as with the overall aircraft. The overall behaviour of the system could be substantially more difficult to predict than with federalised systems. The increased complexity leads to many of the other challenges described below.
- *Design challenges.* Because of the complexity involved, more time and cost may need to be invested during the development process. Experts from multiple disciplines are usually required and the design often needs to be considered earlier in the overall development of the aircraft. Exergy analysis is one technique that could be used to keep track of all the energy flows across the aircraft in multidisciplinary design [102].
- *Safety and certification.* The interconnected nature and potential common mode failure could lead to concerns about safety. Certification might also be more challenging, especially for more novel systems.
- *Potential difficulties in upgradeability and family design.* Highly integrated systems can often be difficult to upgrade or redesign, as performing a change to one component may lead to changes to many other components [201]. Similar challenges could be faced when developing a family of aircraft.
- *Control strategies.* Integrated systems often need elaborate control strategies, which could be difficult to develop, because of the difficulty in predicting the behaviour of these systems across the many possible conditions that they may face.

Many researchers have recognised these challenges and have proposed novel methods and design tools to meet them. Some of these are summarised in Section 8.7.

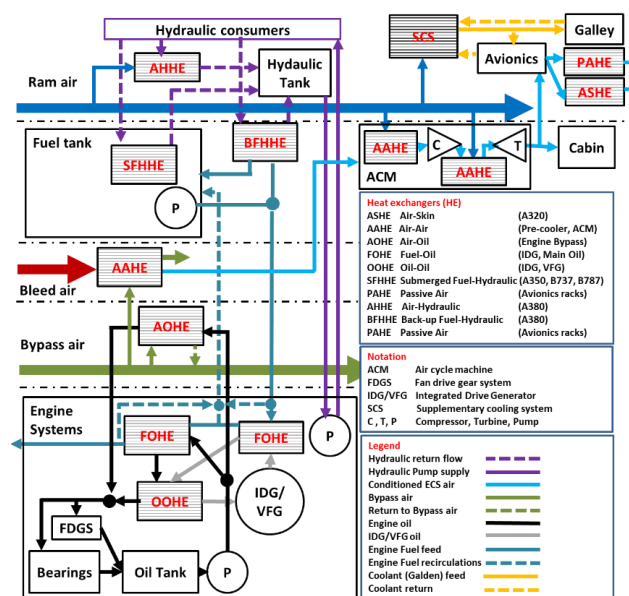

Figure 14: Civil jet transport aircraft engine and airframe thermal transport networks.

8. Topics of priority in aircraft thermal management research

In this section, a selection of aircraft thermal management topics of particular interest currently is discussed. A subsection is dedicated to each of the topics.

8.1 Thermal management in Electrified Propulsion Aircraft (EPA)

Providing adequate thermal management is expected to be a major challenge in the design of future electrified propulsion aircraft (EPA). In fact, the United Kingdom's Aerospace Technology Institute has specifically listed the development of lightweight thermal management systems for hybrid- and all-electric aircraft as a priority activity in their latest technology strategy [202]. Although electric motors are more efficient than gas turbine engines in generating shaft power, there are several reasons that thermal management would be considered more challenging on EPA than traditional aircraft. These are as follows:

- *High magnitudes of waste heat to be removed.* As discussed in Section 5.1.3, on gas turbine-powered aircraft most of the waste heat is expelled from the aircraft through the engine nozzles, along with the exhaust products. Conversely, in EPA, the generated waste heat does not escape in this manner and must be removed with a dedicated means [203]. Although electrical equipment is generally efficient, the exceedingly large magnitudes of power required will translate into considerable power losses.
- *Low temperature heat sources.* Not only would substantial amounts of waste heat be produced in large electrical power trains, but, because electrical equipment needs to be kept at relatively low temperatures, the heat produced would also be of 'low quality'. This means that the temperature difference between the heat source and that of the common heat sinks on the aircraft (such as ambient air or fuel) is significantly smaller (and sometimes even negative) than with combustion engines. This would result in there being a much smaller potential to drive heat transfer and invokes the need for large mass flows of coolant or refrigeration systems. The temperature of electrical components usually also needs to be kept within a specific range, which implies a requirement for sophisticated control techniques.
- *High heat flux.* Another challenge would be the high heat fluxes produced by the electrical components [21]. Advances in power electronics and electrical machines enable smaller and lighter components, but, even with improved efficiency, this reduction in size results in more waste heat being produced per unit volume. This further drives the need for innovative heat removal solutions.
- *Effects on overall aircraft efficiency.* The addition of a thermal management system may reduce the overall energy efficiency of the aircraft [14] – even to the extent that any gains in efficiency provided by electrification are completely eliminated.
- *Changes in onboard fuel.* On some hybrid electric aircraft there is less fuel available, as part of the energy employed for propulsion comes from the batteries. In addition, the more efficient the aircraft is, the less fuel is needed, leading to an even lower quantity of fuel being available for thermal management. On all-electric aircraft, there is no fuel at all. This diminishing of fuel as a heat sink implies that more extensive use will have to be made of ram air for cooling (which would lead to increased drag), or otherwise another solution would have to be sought, such as the provision of a refrigeration systems (which ultimately also requires air for cooling) or thermal storage. Furthermore, for many envisaged large hybrid electric aircraft concepts it is proposed to dispense with kerosene in favour of cryogenic fuels, such as liquid Hydrogen. The storage of cryogenic fluids presents

significant new thermal management challenges, but also potential synergies with superconducting systems.

Further discussion on these challenges (and opportunities) can be found in Refs. [102], [189]. Research on thermal management for EPA is generally focused on the following aspects (only the last point is really within the scope of this paper):

- *More efficient powertrain components* (see Section 5.1.3). Improving the efficiency of individual components in the electric drivetrain is of obvious interest, as doing so would not only decrease the magnitude of waste heat generated, but also increase overall efficiency. Much research therefore focuses on improving the efficiency of electrical machines [49]–[54], power converters [49], [50], and power distribution [50], [79], [80]. Improving the electrical efficiency of electrical components is of much wider concern than just to the EPA research community. Relevant work therefore spans multiple applications, which renders it too large a subject to provide a comprehensive review for in this paper.
- *High- and cryogenic temperature superconducting devices*. One specific means to improve efficiency is to employ superconductivity – either at ‘high’ or ‘cryogenic’ temperatures. Many examples of superconductivity studies for EPA can be found in the literature (see for example Refs. [55], [79]). Superconductivity allows for very efficient systems, but cooling will still have to be provided for most superconducting technologies, which will inevitably reduce some of the efficiency gained. Cooling could be provided by liquid natural gas or hydrogen, perhaps in a synergistic relationship with envisaged changes to the fuel system. Alternatively, cryocoolers could be used, such as those operating on the reverse Turbo-Brayton cycle. A summary of the technical challenges of cryogenic power systems is provided in Ref. [204]. The challenges include cryocooler mass, issues regarding the handling of transient loads, and difficulty with voltage regulation. It was concluded in Ref. [204] that it is unlikely that cryogenic technology will be available for aircraft propulsion purposes within a 30-year timeframe.
- *Improved heat acquisition and local cooling means*. Much research on EPA thermal management and related applications is devoted to improving heat acquisition means. Many interesting studies exist, for example using nanofluids for heat acquisition for batteries [191], using polyalphaolefins and phase change materials for thermal management of electrical machines [205], and so forth. As with the above points, this is a general research topic in electrical systems and heat transfer, and it is therefore beyond the scope of this paper to cover it in detail.
- *Aircraft-level integrated thermal management systems (i.e., not local cooling/heat acquisition)*. Although the above points are essential, many researchers recognise the importance of integrated thermal management systems (see Section 7.3) for EPA. This is because integrated systems that are optimised at aircraft level are likely to be more efficient overall than local, federalised systems. The goal of research in this direction is therefore generally to study and devise thermal management systems that can meet the stringent cooling requirements, while keeping the impact on performance to a minimum. These studies are aligned with the scope of this paper, and a summary of selected studies of thermal management systems for EPA is provided in Table 7. Six of these studies are covered in more detail in Sections 8.1.1 to 8.1.6.

Table 7: Selected EPA thermal management studies.

Study(ies)	Type of aircraft	Main purpose of the study	Main heat loads	Main heat sinks	Main conclusions
Schiltgen et al. [15], [206] (2016,2019). Please refer to Section 8.1.1 for more details on these studies.	150-passenger ECO-150R turbo-electric aircraft	To investigate a recirculating liquid cooling system, of which there will be two onboard the aircraft.	Powertrain: up to 1,491 kW at the top of climb.	Ram air. Liquid coolant is used to transport heat loads to ram air. Ram air duct uses the 'Meredith' effect.	The Meredith effect, which was made famous on the North American P-51 Mustang, significantly reduces cooling drag.
Lents and Rheume et al. [16], [207]–[209] (2016-2020). Please refer to Section 8.1.2 for more details on these studies.	Parallel hybrid single-aisle airliner with geared turbofan (GTF) engines	To investigate the effects on performance and fuel burn of providing thermal management for the aircraft under consideration. Components were investigated for technological levels: current (c), 10-year timeframe (+10y), and 20-year timeframe (+20y).	Electric propulsion system components. Total in kW [16]: - Battery: 126 (c); 95 (+10y); 68 (+20y). - Motor drive: 95 (c); 45 (+10y); 0 (+20y). - Motor/gen: 183 (c); 88 (+10y); 43 (+20y).	Ram or engine fan air. Oil and liquid coolant loops (propylene glycol with 50 % water) are used to transport heat loads to ram air.	In [16], it was found that the added mass and drag of the TMS rendered the concept uncompetitive with a non-electric GTF alternative. In [207], it was determined that the TMS increased fuel burn by 3.4% during take-off, climb, and cruise. In [208], several improvements were applied, which reduced the additional fuel burn caused by the TMS to only 0.75%. In [209], several sensitivity analyses were performed.
Trawick et al. [210] (2017). Please refer to Section 8.1.3 for more details on this study.	Generic hybrid electric aircraft	To introduce the Georgia Tech Hybrid Electric Analysis Tool (GT-HEAT), which contains TMS models that are integrated into the NPSS program [211].	Electric drive machines, gearboxes, inverters, batteries.	Ram air (glycol is used for thermal transportation).	The integrated modelling enables better understanding of the technology and design trade-offs of highly integrated future aircraft.
NASA University Leadership Initiative studies [168], [205], [212](2019-2020). Please refer to Section 8.1.4 for more details on these studies.	Regional hybrid-turbo-electric distributed propulsion airliner (EIS 2030)	To develop a TMS for the motors and inverters. Measures to handle peak loads were of special interest. Two phase-change materials (PCMs) and an additional oil loop were options investigated for this.	Motors and inverters	Waste heat is transferred to PAO cooling oil through a heat exchanger and then to propulsor fan air through an AOHE.	It was found that the measures for handling peak loads were all successful, but that the PCM 'Urea-KC1' performed slightly better than the additional oil loop and 'magnesium chloride hexahydrate' PCM. However, the TMS still adds non-negligible penalties to MTOW and fuel burn.
Kellermann (2019) [119]	Regional to large, electrified propulsion aircraft.	To investigate the potential use of skin heat exchangers to remove the waste heat produced by hybrid-electric drive trains.	Electrified powertrain components.	Ambient air (via surface heat exchangers).	It was found that, for all sizes of aircraft considered, the surface heat exchangers could provide cooling at the same order of magnitude as the waste heat produced by the electrified drivetrains.
Chapman et al. [17] (2020). Please refer to Section 8.1.5 for more details on this study.	15-passenger Turbo-electric tiltwing vertical take-off and landing (VTOL) aircraft	To develop and optimise a conceptual TMS for the tiltwing turboelectric VTOL.	Max at hover: generator (181.15 kW); rectifier (172.1 kW); inverter (40.44 kW); motor (38.42 kW); gearbox (72.5 kW);	Ram air. Oil and liquid coolant loops (propylene glycol with 30 % water) are used to transport heat loads to ram air.	Low fidelity methods produced results within 10 % of high-fidelity models. Using transient methods enabled a 14 % reduction in weight in the oil loop.

Chapman et al. [213] (2020). Please refer to Section 8.1.5 for more details on this study.	Three NASA hybrid electric concepts: STARC-ABL, PEGASUS, and an eVTOL.	To develop and perform a cross system analysis of TMSs for these three hybrid electric aircraft concepts. Both baseline (bl – i.e., current state-of-the-art) and advanced (a) technology was considered.	Electric propulsion system components. Total in kW: - eVTOL: 361 (bl), 91 (a) - STARC-ABL: 572 (bl), 106 (a) - PEGASUS: 542 (bl), 381 (a).	Ram or engine fan air. Oil and liquid coolant loops (propylene glycol with 30 % water) are used to transport heat loads to ram air.	The main conclusions of these studies were as follows: • Using advanced electrical systems can significantly reduce TMS mass, power consumed, and drag. • Increases in converter efficiency and motor efficiencies, along with using an AC bus that enables a rectifier to be eliminated, resulted in almost a 50% lower TMS mass. • The TMS mass per unit heat rejected was found to be lower for the eVTOL concept than for the fixed wing aircraft. • There is generally a linear relationship between required heat load rejected and TMS mass, power consumption, and drag increase.
Byahut and Uranga [214] (2020)	All-electric commuter aircraft (modelled on the Viking Air Twin Otter)	To produce power distribution and thermal management models for electrified aircraft.	Motors, battery, power converters, and distribution. Total: 63 kW (2 propulsors); 70 kW (20 propulsors).	Ram air (heat is transported to the air by a propylene-glycol liquid coolant through a heat exchanger)	Highest heat loads occurred during climb. The TMS pipes for the 20-propulsor configuration are smaller per motor but have more mass in total.
Dyson et al. [174] (2020). Please refer to Section 8.1.6 for more details on this study.	Hybrid electric civil transport aircraft. The study is not dedicated to a particular aircraft concept, but rather covers new TMS technologies.	To investigate solid-state (i.e., no moving parts) exergy optimized electric aircraft thermal and fault management. This is done by studying new technologies that can ‘amplify’ the exergy of the powertrain waste heat. These technologies include new fast switchgear; new long “variable conductance heat pipes with multiple switchable condensers”; new “turbofan integrated heat exchangers”, as well as a new gradient-based powertrain optimisation method.	Electrified powertrain.	Bypass fan air or ram air (fuel could also be used).	The new technologies could enable solid-state cooling and fault management for an entire transport electric aircraft. This TMS can also increase propulsive efficiency while enabling fast fault management.
Abolmoali et al. [215] (2020)	Series-hybrid fixed wing medium altitude long endurance unmanned aerial vehicle	To develop an integrated propulsive and thermal management system that enables optimised hybrid electric aircraft performance.	Powertrain, aircraft-level auxiliary systems (including a radar system).	Fuel (to cool powertrain heat loads); Ram air (to cool PAO cooling loop recirculated fuel). PAO is used to remove heat from aircraft-level auxiliary systems.	Using the proposed PTMS enabled fuel savings (despite system weight increases) compared with a conventional propulsion system, over an 18-hour long mission.
Thomas et al. [216] (2020)	6-passenger electric quadrotor urban air	Mainly to perform a multi-disciplinary systems analysis,	Motors and inverters.	Propeller air (heat is transported to the air via an intermediate	It was shown that the TMS design would be driven by the component with the lowest temperature constraints.

	mobility vehicle (eVTOL)	but an initial TMS was also proposed.		propylene-glycol water 30/70 mixture liquid cooling loop).	
Schnulo et al. [50] (2020)	Turbo-electric single-aisle concept (STARC-ABL)	To assess the impact of advanced power distribution and thermal management technologies on the concept. These involved high-efficiency components and employing the aircraft skin to reject heat to the atmosphere passively ('outer mold line cooling' [OMLC]).	Electric powertrain components (producing 180.24 kW of waste heat).	Ambient air (through aircraft skin). Liquid coolant carrying heat from the loads is pumped through small aluminium tubes adjacent to the internal skin of the aircraft, allowing heat to be rejected to the atmosphere.	The use of high-efficiency components with active cooling resulted in a fuel burn reduction of 2.5% compared with a baseline using state-of-the-art components. The OMLC enabled a further reduction of 0.8%.

8.1.1 ESAero ECO-150R thermal management system

The ECO-150R is a concept for a 150-seat turbo-electric aircraft being developed by ESAero and Wright Electric. It was estimated by Schiltgen et al. [15] that the maximum total waste heat produced by the electrical components in the ECO-150R powertrain would be around 1,491 kW at the top of climb. To manage this load, the TMS architecture shown in Figure 15 was presented. This architecture describes a recirculating liquid cooling system, of which there will be two onboard the aircraft. The recirculating coolant picks up heat from the different components and rejects it again when travelling through a tube-fin radiator. The heat is in turn rejected by the radiator to ram air in a duct, which is especially designed to make use of the 'Meredith' effect. The Meredith effect, which was made famous on the North American P-51 Mustang, significantly reduces cooling drag.

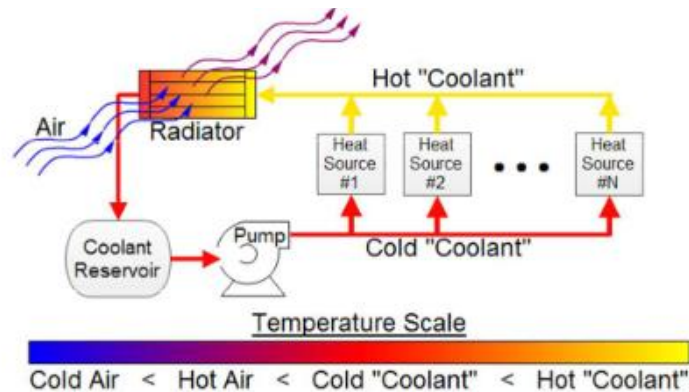

Figure 15: ECO-150R TMS architecture [15]. Used with permission of Empirical Systems Aerospace (ES Aero).

8.1.2 United Technologies studies

Lents et al. [16], [207]–[209] presented a series of studies of thermal management systems for a parallel hybrid single-aisle airliner with geared turbofan (GTF) engines. It was found that the highest cooling load from the TMS was elicited during take-off in hot conditions. The fuel temperature for this condition was set at 49 °C. The values were calculated based on current component efficiencies and temperature capabilities. The primary driver for the design was the battery upper temperature limit (60 °C).

A liquid cooling loop (with a 50% mixture of water and propylene glycol) provides cooling for the battery and motor drive. It rejects the heat acquired to ram air via the ram coolant cooler, rather

than engine fan air, which is at 81 °C. It was found that fuel would not be suitable to cool the battery, as its temperature is too high. An oil loop provides cooling for the other propulsion system components, i.e., the accessory gearbox, GTF fan drive, GTF bearings, high spool starter generator, and the low spool motor/generator. The oil is cooled with fuel-oil and air-oil (using fan air) coolers. The TMS was studied with both current technology capabilities, as well as possible improvements over 10- and 20-year horizons.

As a conclusion to their first study [16], the authors found that, with the added mass and drag associated with this particular TMS, this hybrid aircraft concept would not be competitive with the non-electric GTF alternative. In their second study [207], they described the modelling and simulation in further detail. Here, they predicted a system mass of 316 kg per engine and found that the TMS increases fuel burn by 3.4% during take-off, climb and cruise. This compares with a predicted fuel saving of between 4% and 7% provided by the hybrid electric propulsion system.

In a further follow-up study [208], several improvements were applied that enabled the ram air cooled heat exchanger system mass to be reduced to a fifth of that of the previous study. In turn, this reduced the additional fuel burn due to adding the TMS to only 0.75%. Finally, in their most recent study [209], the model presented in Refs. [207], [208] was used to perform several sensitivity analyses.

8.1.3 Rolls-Royce/Georgia Institute of Technology study

Trawick et al. [210] presented a comprehensive modelling framework for hybrid electric aircraft, called GT-Heat. GT-Heat contains TMS models, which were integrated into the Numerical Propulsion System Simulation (NPSS) program [211]. The TMS features heat exchangers for each of the independent heat sources (except for the battery), which transfer heat to an air stream. The electric drive machine and gearbox are cooled with a single air-cooled oil circuit, whereas the inverter is cooled by an air-glycol cooled circuit. The battery pods are cooled by means of ram air. Control is provided for every thermal loop independently, with the goal of maintaining hot and cold side temperatures within specified allowable ranges. Engine fan air is used for modulating the hot side temperature. Because the highest heat load originates from the battery and because it has the lowest allowable temperature limit, a special ram air cooling system was designed for it.

8.1.4 NASA University Leadership Initiative EPA studies

The NASA University Leadership Initiative is a consortium of US universities collaborating together and with NASA on a program to demonstrate the benefits of a regional 'hybrid-turbo-electric' distributed propulsion airliner for entry-into-service around 2030 [205]. The Georgia Institute of Technology is performing the systems integration for this concept and has developed a TMS for it [168]. The motor and inverter waste heat are transferred to polyalphaolefin (PAO) cooling oil through the integrated motor drive (IMD) heat exchanger. The heat is then rejected to propulsor fan air through an air-cooled oil cooler. Here, the oil is cooled to the required cooling temperature of 55 °C. The cooled oil then returns to a reservoir before being pumped back to the IMD HX again. For managing peak heat loads during take-off and climb, the authors have proposed two different solutions: one using an additional PAO loop and one using a phase change material that surrounds the electrical machines. Two types of PCM were studied, namely magnesium chloride hexahydrate and Urea-KC1. This TMS system was modelled and simulated over a whole flight. It was found that the additional measures for handling peak loads were all successful, but that the Urea-KC1 performed slightly better than the additional oil loop and magnesium chloride hexahydrate PCM. However, the TMS still adds non-negligible penalties to maximum take-off weight (MTOW) and fuel burn.

8.1.5 NASA concepts thermal management systems

Chapman et al. [213] developed thermal management systems for three NASA hybrid electric concepts: the STARC-ABL (Single-aisle Turboelectric Aircraft with Aft Boundary-Layer Propulsion), the PEGASUS (Parallel Electric-Gas Architecture with Synergistic Utilization Scheme – a study by NASA for a parallel hybrid electric regional airliner), and a turbo-electric tiltwing Vertical Take-off and Landing (VTOL) vehicle. For each concept aircraft, two technologies levels were considered: state-of-the-art (baseline) and advanced. The TMSs were only designed to cool the electrical components and all of them incorporate liquid cooling loops, which ultimately reject the heat acquired to ram air. The main conclusions of these studies were as follows:

- Using advanced (high efficiency) electrical systems can reduce TMS mass, power consumed, and drag.
- A 1.5% increase in electrical converter efficiency with a 2.5% increase in motor efficiency, along with using an AC bus that enables a rectifier to be eliminated, resulted in almost a 50% lower TMS mass.
- The TMS mass per unit heat rejected was found to be lower for the eVTOL concept than for the fixed wing aircraft. This is because the eVTOL design is more sensitive to TMS weight than power used.
- Given constant flow temperatures, there is generally a linear relationship between required heat load rejected and TMS mass, power consumption, and drag increase.

8.1.6 Solid-State Exergy Optimized Electric Aircraft Thermal and Fault Management

Dyson et al. [174] presented an interesting study of which the purpose was to investigate solid-state exergy optimized electric aircraft thermal and fault management. Technologies studied were those that can provide fault management and ‘amplify’ the exergy of the powertrain waste heat. These include new fast switchgear; novel long “variable conductance heat pipes with multiple switchable condensers”; new “turbofan integrated heat exchangers”, as well as a new gradient-based powertrain optimisation method. The system works as follows:

- High exergy waste heat is extracted from the turbine exhaust via SiC coated graphite turbofan integrated heat exchangers.
- This heat is used to generate ducted acoustic waves in a thermoacoustic heat pipe.
- The acoustic waves are in turn employed to perform the function of a thermoacoustic refrigerator using the opposite end of same heat pipe, along with hot and cold reservoir heat exchangers. The heat pipe therefore essentially becomes an ‘acoustic exergy multiplier’. Using this refrigerator, low exergy heat is removed from the electrical propulsion components in the powertrain (i.e., heat is removed from the components with a coolant, which in turn rejects the heat at the cold reservoir heat exchanger, and from there it is transferred to the hot reservoir heat exchanger with acoustic waves).
- The combined heat is then redistributed around the aircraft to locations where it can be used beneficially (for example, for de-/anti-icing), by making use of ‘dynamically switchable heat pipes’.

This system enables the low-grade waste heat from the electrical powertrain components to be managed, while being repurposed for useful ends across the aircraft.

8.2 Thermal management for ultra-high bypass ratio geared turbofans

Many targets for reducing the impact of civil aviation on the environment call for radically new airframe and propulsion concepts that can drastically reduce fuel burn and noise. However, perhaps the most promising stopgap solution is the introduction of ultra-high bypass ratio (UHBR) turbofan engines. Definitions vary, but UHBR engines are usually considered ducted turbofans with bypass ratios (BPR) of at least 15:1. The addition of a reduction gearbox (Figure 16) between the low-pressure shaft and the fan (i.e., forming a geared turbofan) enables these high BPRs to be achieved, without letting the fan rotate too fast. The significant reduction in the ratio of jet vs freestream velocities provides UHBR engines with exceedingly high propulsive and thermal efficiencies, leading to lower fuel burn, noise, and emissions.

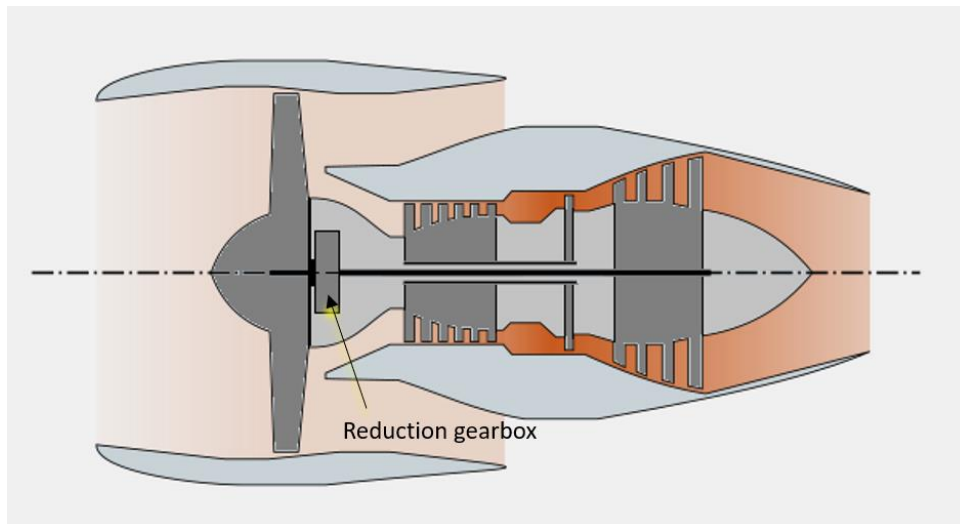

Figure 16: The addition of a gearbox to reduce fan speed on turbofan engines adds a significant heat load. Gas turbine image obtained from Simcenter Amesim software.

However, it is expected that UHBR GTF engines will bring forth several thermal management challenges. As with thermal management systems for electrified propulsion aircraft, the UK Aerospace Technology Institute has also listed the development of ‘advanced integrated heat exchangers and thermal management systems’ for UHBR engines as a priority activity [202]. The reasons that thermal management would be considered more challenging on UHBR GTF engines than direct driven or low BPR geared turbofans are as follows:

- *High magnitude of waste heat to be removed.* The technologies in UHBR engines will enable the engine core to operate at higher temperatures than current turbofans. Although this will increase efficiency, it is expected that it will lead to higher heat loads due to soakage effects. Furthermore, despite the high efficiencies associated with gearboxes, a substantial amount of power will still be lost as heat in the gear mechanisms (due to the increased fan diameter, the fan work is higher). As an example, at the current stage of its development, the UltraFan employs a 75 MW gearbox [217]. If, at full power, this gearbox is 99% efficient, the waste heat produced will amount to 750 kW. Unlike in conventional turbofans, this heat cannot escape as part of the exhaust products through the nozzle and will have to be managed by a dedicated thermal management means.
- *Less space for cooling equipment.* Higher bypass ratios generally lead to larger nacelle weight and cowl drag. This problem can be reduced to an extent by moving some of the components normally situated in the nacelle to the core of the engine [35]. This makes the nacelle more slim (hence the term ‘slimline’ nacelles to describe such concepts) and aerodynamically efficient, but leaves less space overall for cooling equipment [35].

- *Less effective core ventilation.* The lower pressures aft of the fan will result in less effective convective cooling for the engine [35].
- *Fuel and engine oil temperature limitations.* The engine oil (and the fuel via the FOHE) will face far higher cooling demands on UHBR GTF engines than on normal turbofans. The allowable temperature ranges for fuel and oil must be maintained, which implies that the mass flow rates of the fuel and oil would probably need to be increased if their maximum temperatures are reached. This would not only lead to higher power offtakes (because of larger pumping requirements), but, in the case of fuel, would also mean that any excess fuel (i.e., used for cooling but not combustion) would need to be recirculated somewhere (see Section 6.2). A major topic of research for UHBR GTF thermal management is the development of lightweight compact heat exchangers to cool oil. Using fan air (Section 6.1.2) is a strong contender for the cold side (i.e., the heat exchanger would be an AOHE), and minimising the pressure drop by these heat exchangers is therefore of particular importance.
- *Diminishing heat sink capacity of onboard fuel.* As with all more fuel-efficient concepts, on UHBR aircraft there would be less fuel available (as well as smaller feed mass flow rates to the engine). This will lead to a lower quantity of fuel available for thermal management. There is also less and less fuel available as the flight progresses, which adds further challenges.
- *Effects on overall aircraft efficiency.* As is the general case, the addition of a thermal management system may reduce the overall energy efficiency of the aircraft.

Two studies involving UHBR GTF thermal management research are described in the next two subsections.

8.2.1 Rolls-Royce UltraFan cooling

In Ref. [175], Ryemill et al. describe how systems engineering (SE) techniques were used to “question and challenge”, and subsequently redefine, heat management systems for turbofan engines. They specifically described how SE was used to help address the thermal management challenges posed by the Rolls Royce UltraFan concept. The process employed can be described as follows:

- Establish the boundary and scope of the heat management system and define its relationship to other systems.
- Clarify the roles of stakeholders and functional interactions.
- Clarify the system requirements.
- Decompose functions to clarify the main requirements and critical functions.

Although this process requires additional resources, it enables potentially more innovative solutions to be identified. Potential cooling solutions were generated and explored using standard brainstorming techniques, as well as more structured methods, such as the ‘Theory of Inventive Problem Solving’ (usually abbreviated as ‘TRIZ’) and function mean analyses. Ideas were then down selected using idea ranking and comparison, employing tools such as the Analytical Hierarchy Process (AHP) and function means analysis. Functional models were created of the down-selected solutions to initiate an iterative process of design space exploration and increasing maturation of the most promising solutions. As part of the process, Rolls-Royce set up a heat management community of practice that draws experience and knowledge from across the company. This enabled ideas and expertise to be shared to aid in reaching optimal solutions.

The resulting potential solutions identified using these processes includes:

- *Integrated and multifunctional solutions.* An example of this is an advanced turbine cooled cooling air (CCA) system that would enable the design of the high-pressure turbine and cooling system to be optimised. The CCA solution would incorporate several heat exchangers embedded in the engine core. These would source air from the fan bypass duct to pre-cool engine-cooling air. The heated air would subsequently be expelled back to the bypass duct. Pre-cooling the cooling air in this manner would further improve efficiency and enhance longevity of the components in the engine core [218]. The AOHEs could also be located in this installation. Options for transferring some of the heat from the oil to engine compartment ventilation air has also been explored, as this would lessen the pressure drops imposed by AOHEs.
- *Reducing heat generation.* Here, particular emphasis is placed on reducing losses in the power gearbox, especially those related to churning and windage. The chemistry of the oil itself is being explored, in order to find the optimum balance between lubrication, heat transport, load carrying, and shear losses. Other options for reducing heat losses around the engine are also being explored.
- *Heat exchanger design methodology.* A novel heat exchanger design methodology was devised, which enables the ranking of heat exchangers, based on updated performance correlation databases and incorporating the effectiveness-NTU method. This methodology, and its integration with other Rolls-Royce tools and procedures, enables more effective preliminary design of high-efficiency heat exchangers.
- *Heat exchanger technology.* An important enabling aspect of all the solutions considered here will be the availability of compact, effective, and lightweight heat exchangers. The development of heat exchanger technology is therefore an important focus of development.

The SE approach enabled Roll-Royce to develop a comprehensive roadmap for technology development for the heat management system of the UltraFan. The technologies identified will allow the UltraFan architecture to be adopted for a wide range of applications.

8.2.2 UK Aerospace Technology Institute/Innovate UK and Meggitt PLC ‘UHBR Thermals’ programme

The Ultra High Bypass Ratio (UHBR) engine thermal management systems project (‘UHBR Thermals’) was a recent technology research project focusing on addressing UHBR turbofan oil heat management [20]. The scope was wide, covering development at both the technology and systems levels. Important advances were made in both the development of fuel-oil thermal management systems, as well as heat exchanger geometry definition and manufacturing techniques.

Part of the scope of UHBR Thermals was to establish a comprehensive integrated dynamic aircraft thermal management simulation framework. This framework, which was developed by Cranfield University, in partnership with Meggitt PLC, was implemented in Simulink and enabled the aircraft level performance effects of integrated thermal management systems to be explored [14].

This simulation framework enabled many different thermal management studies to be conducted, mainly focusing on UHBR GTF engines. For example, Figure 17 shows the fuel feed and bypass duct air temperatures across a representative mission for a 150-seat single-aisle aircraft, powered by UHBR GTFs. This illustrates the heat sink temperature available to the engine and generator oil. The waste heat from the power gearbox, accessory gearbox, and bearings, which is transferred to engine for the same aircraft study are shown in Figure 18. As can be seen, the heat loads from the

power gearbox (PGB) are by far the largest and the maximum total waste heat transferred to the oil exceeds 275 kW (at the beginning of climb).

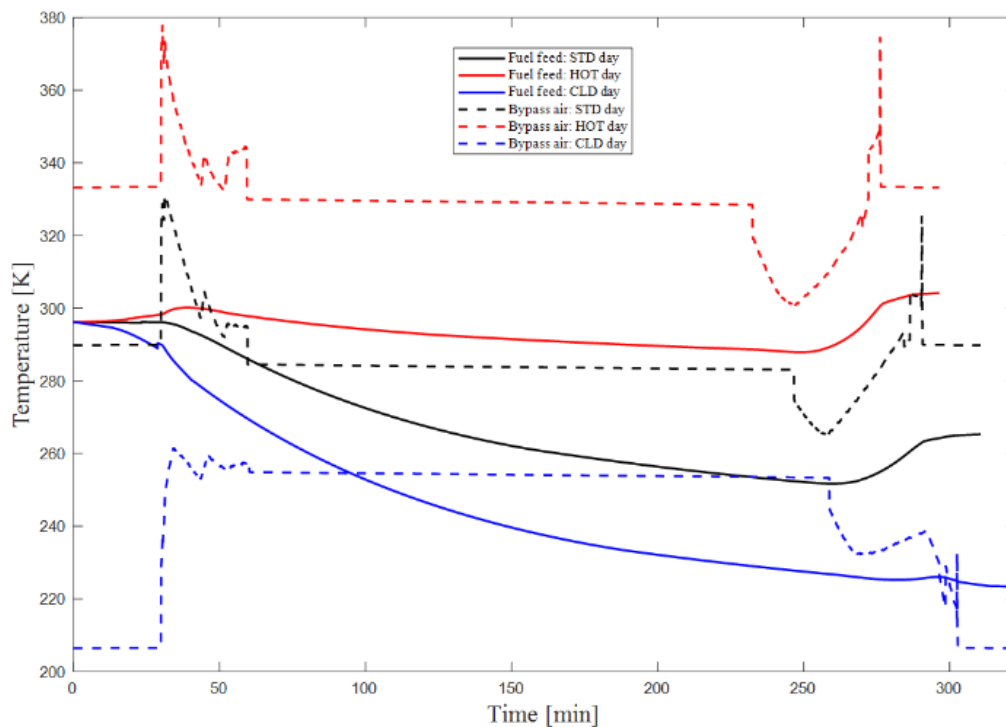

Figure 17: Engine heat sink temperatures [14].

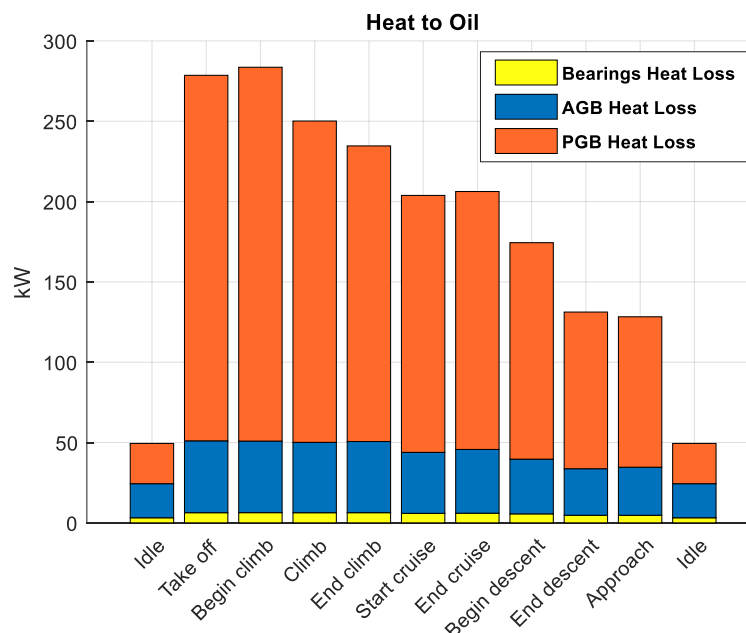

Figure 18: UHBR GTF engine (with 110 kN Sea-Level Static Thrust) waste heat transferred to oil [47]. Note that AGB = accessory gearbox, PGB = power gearbox.

In another study using the UHBR GTF engine models [18], several parameters were investigated to determine how TMS solutions may affect the engine performance. In this study, it was shown that there is a strong linear relationship between bypass duct pressure losses and increases in SFC. This result shows the importance of minimizing pressure losses due to any heat exchangers using bypass air. Any bleed from the bypass duct was also found to increase SFC substantially. The use of the FOHE was found to be more favourable than the AOHE, and focus should therefore be placed on

maximising the cooling capacity of the fuel. HPT power offtakes will also have a considerable adverse effect on SFC.

Several integrated TMS solutions were devised and studied as part of the UHBR Thermals project. These focused extensively on fuel recirculation systems. The solutions showed promise, but fuel flammability and certification associated with fuel recirculation need to be investigated further.

8.3 High power military systems

Future weapon systems on military aircraft are expected to use considerable power and produce immense waste heat as a by-product. This is especially true of directed energy weapons (DEWs), i.e., weapons that use focused energy to destroy targets over substantial distances. Examples of these include laser, microwave, or particle beam weapons. These systems are characterized by the use of very high power (in the MW range) over very short periods. This presents significant thermal management challenges and some DEW studies have addressed this issue. A selection of these is summarised in Table 8.

Shanmugasundaram et al. [219] sized a DEW, including ammonia- and water-based heat acquisition options for a military cargo aircraft. This research related changes in system design to mission performance. Shanmugasundaram et al. [220], [221] extended this work to use modelling to investigate the impact of changes to the TMS technological solution. The heat load in these studies was up to 2.9 MW with a 30% duty cycle pulsed power source operation. The scope included employing ram air as a coolant and the use of phase change materials (PCM) for thermal energy storage (see Section 6.4, in which these are discussed in more detail). Thermal energy storage is crucial with these machines, as the usual heat sinks on aircraft cannot manage these heat transfer rates over the short periods of time that the laser operates. The thermal energy storage enables the heat to be rejected at lower rates when the weapon is not operating. Shanmugasundaram et al. [222], [223] and Fellner et al. [224] applied previously developed methods to report a case study where a TMS was sized for a laser-based DEW that outputs only 100 kW, but which produce waste heat of up to 787 kW.

Table 8: Studies on thermal management approaches for aircraft with high-energy weapons.

Study(ies)	Main purpose of the study	Main heat loads	Main heat sinks	Main conclusions
Shanmugasundaram et al. [219]–[223] and Fellner et al. [224] (2004–2007)	To investigate and address the thermal management challenges related to directed energy weapons (DEWs).	Directed energy weapons: 787 kW [223] 2.9 MW [219]–[221].	Ammonia and water-based coolants rejecting heat to ram air, and phase change materials as thermal energy storage.	The best TMS utilized a combination of thermal storage using a water tank, and a ram air heat exchanger to reject heat to the atmosphere.
Lin et al. [11] (2009)	To estimate the mass and volume and to characterise the usefulness of thermal energy storage (TES) for military aircraft applications, including HEWs. The TES is in the form of an integrated vapour chamber/ thermal energy storage (VCTES) system that provides spray cooling.	HEW and other system heat loads.	Phase-change materials (such as n-Pentacontane wax). This accepts heat from an ammonia vapour that transports heat away from a spray chamber, where the ammonia was used to cool the heat loads.	It was shown that the HEW cooling system heat sink capacity is up to 20 MJ, with a volume storage density of 86 MJ/m ³ , and a mass storage density of 77 kJ/kg. Another cooling system studied for an airborne active denial system, was shown to a heat storage ability of 25 MJ, a volume storage density of 76 MJ/m ³ , and a mass storage density of 69 kJ/kg.

Gvozdoch [13] (2012)	To investigate the power and thermal demands that a directed energy weapon subsystem (DEWS) introduces when integrated into a high-performance aircraft. A discussion is also provided of how to manage appropriately the system-level impacts that result.	Directed energy devices, sensors, optics.	Fuel and air. Thermal energy storage is also used (using phase change materials). PAO collects heat from electronics via multiple micro-channel coolers.	The high impact on thermal management requirements show that the studied DEWS cannot be recommended as a viable option to replace traditional aircraft technology yet. This is because the coolant flow rates requirements were unfeasibly high. However, thermal energy storage appears to be promising as part of a potential solution.
Donovan et al. [225] (2016) and Nuzum et al. [226] (2016)	To investigate the effects of a solid-state laser High Energy Pulsed System with respect to thermal management. A fuel TMS combined with an adaptive power and thermal management system with a vapour compression system is employed. Another purpose is to investigate using Liquefied Natural Gas (LNG) as a cryogenic coolant to cool the High Energy Pulsed System.	High Energy Pulsed System components, engine oil, generators controllers, electric actuators, FADEC, and various oil and fuel pumps.	Fuel was compared with LNG as a heat sink.	The LNG significantly outperformed fuel as a heat sink, even when using a smaller integrated power package and VCS.

8.4 Environmental control systems

Aircraft environmental control systems (ECSs) can be exceptionally large onboard secondary power consumers (often by far the biggest on civil aircraft), and much research is subsequently devoted to improving their effectiveness and efficiency. Such research is broad and somewhat beyond the scope of this paper, but, because of their importance and relevance, they deserve a dedicated, albeit short, section as an active topic of research in aircraft thermal management systems. A detailed review of ECS systems is provided by Merzvinikas et al. [227].

Aircraft ECSs fulfil the requirements for temperature, pressure, and air filtration to create a conditioned environments on the aircraft. They therefore often have more functions than just thermal management. The conditioned environments can include the passenger cabin, cockpit, cargo, and avionics equipment bays and therefore will be exposed to a range of heat sources.

A general overview of processes and thermal flows in an environmental control system are shown in Figure 19.

Typically, an open loop air cycle machine, with a main compressed air source from either the atmosphere or the compressor stages of a gas turbine, are the main constituents of the system. This air is compressed, cooled, and expanded in a reverse Brayton cycle to provide the fresh air mass flow rate and cabin temperature control functionality. When engine bleed air is used as a source, a dual ram air heat exchanger implementation is typical, with a bootstrapped fan coupled to the shaft of the air cycle machine. The fan increases the mass flow through the heat exchangers during stationary or low speed aircraft operations.

Civil aircraft employ cabin air recirculation, to reduce the total fresh air mass flow rate required for pressure and temperature control. Military aircraft, due to the smaller cockpit volume and larger cold air mass flow rate requirements, typically directly feed conditioned air to the required environments.

The air distribution system transports temperature conditioned air to various zones in the aircraft, allowing for targeted temperature control to increase passenger comfort or meet the needs of local avionics and galley equipment.

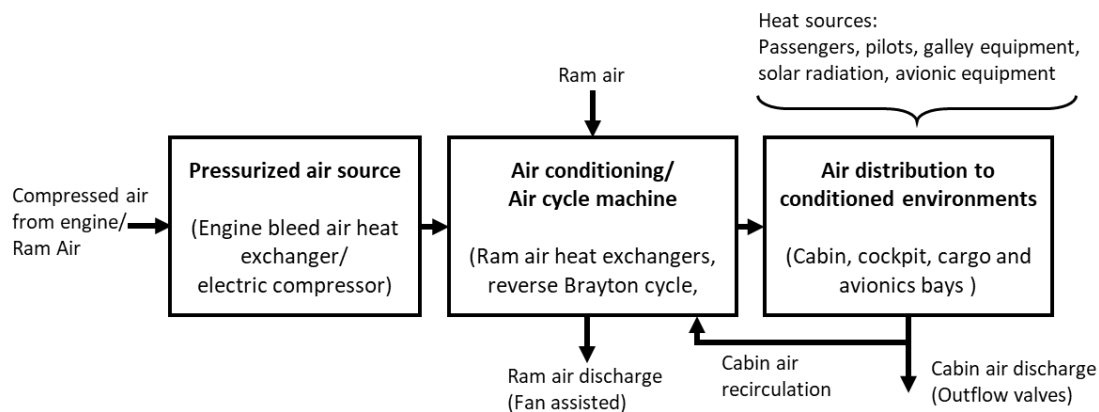

Figure 19: Simplified environmental control system (ECS) block diagram.

With the recent trend towards more electric aircraft systems, a design alternative to bleed air is an electrically driven compressor design. A ram air intake feeds this compressor, which provides the input air to the air cycle machine. This requires large electric motors that elicit substantial power from the electrical distribution system. Much research has focused on developing new thermal modelling approaches and frameworks, to compare such electric ECS architectures with conventional designs [228]–[230], or to investigate new system architectures, such as closed loop vapour cycles and hybrids [231]. Modern aircraft, such as the Airbus A350, A380 and Boeing 787, make use of such hybrid architectures, where supplementary cooling systems, based on a closed loop vapour cycle, are employed to cool galley equipment and avionics bays.

Research in the military aircraft domain has focused on managing increasing heat loads from cockpit equipment, avionics bays, and payload/weapons equipment. New ECS architectures, which couple the traditional compressed air architecture to fuel and dedicated vapour cycle loops have also been studied [232], [233]. Work has also been done on ensuring efficiency/effectiveness of the ECS when dealing with the large variation in outside ambient conditions that military aircraft face [234].

Modelling and simulating ECS systems has been conducted with zero/one-dimensional thermal fluid methods for system performance and controller design [235], [236], high fidelity computational fluid dynamics (CFD) for cabin environment ventilation assessments [237], and experimentally to evaluate passenger comfort [238]–[240].

Yang and Yang [241]–[243] introduced approaches based on endoreversible thermodynamic analyses and structure entropy methods to derive air cycle system thermodynamic characteristics. Zimmer [244] proposed a new approach to solving complex thermal fluid stream architectures, with improved simulation model initialization robustness and provided an ECS simulation example. Such work constitutes novel theoretical bases for air-cycle system design that enable faster development of these systems.

It is expected that much future research on aircraft ECSs will focus on further integration with other energy management systems to save weight and increase overall efficiency. Indeed, increasing integration of the ECS with other thermal management systems have already seen adoption in some military applications (see for example Refs. [245], [246]) – a trend that is expected to

continue. This has led more recently to the emergence of power and thermal management systems, which are covered in the next section.

8.5 Power and thermal management systems

The continuous endeavour of providing adequate thermal management while at the same time keeping mass at a minimum has led to the emergence of systems that combine several energy management related functions. One of the most prominent examples of these are so-called ‘power and thermal management systems’ (PTMS), which have been introduced on modern tactical military aircraft. Power and thermal management systems enable energy to be managed in an optimal manner by having the ability to produce power at some stages of a mission, while performing cooling at other stages.

A prominent example of a power and thermal management system is the one presented by Honeywell in Ref. [247]. This system was developed to replace three traditional airframe systems, namely the environmental control system, auxiliary power unit, the emergency power unit, and the thermal management system, with a single turbomachinery unit that performs the functions of all four. This significantly reduced weight but added some complexity, because of the integral nature of the system. The system has four modes of operation – self-start (SSM), main-engine start (MES), cooling (CM), and emergency power (EPM). In SSM, electricity from the aircraft battery is used by the starter-generator to rotate the turbomachinery until self-sustaining operation is achieved. After SSM is complete, the PTMS act as a gas generator, providing electrical power. This power is used in MES to start the main engine. After MES, the PTMS acts in CM, in which the unit acts as an air-cycle machine to provide cooling for the cockpit, avionics, and so forth. In the case of a main engine failure, the PTMS transitions to EPM, in which it can provide power for flight critical systems.

More examples of power and thermal management system studies from the literature are summarised in Table 9. Future work on PTMS solutions could be focused on finding more suitable architectures for different types of applications, investigating more ways of combining different onboard energy systems, determining how PTMS solutions could best benefit civil transport aircraft, and many more. Such research would necessarily be highly interdisciplinary in nature and should ideally involve investigating solutions in parallel with the conceptual design of the aircraft. All types of operational scenarios would need to be considered and it should be ensured that mass and complexity remain at a minimum.

Table 9: Studies on the development of power and thermal management systems for aircraft.

Study(ies)	Type of aircraft	Main purpose of the study	Main heat loads	Main heat sinks	Main conclusions
Yu and Ganev [247] (2008) Ganev and Koerner [248] (2013)	Fighter aircraft.	To explore the potential of integrated power and thermal management concept for next generation of aircraft and propulsion systems.	Avionics, oil, ECS, Flight Critical Electronics.	Bleed air and fuel.	PTMS can offer an excellent opportunity for further integration with the aircraft systems, supporting the more electric aircraft initiatives, and meeting energy efficient aircraft objectives.
Bodie [249] (2010) Bodie et al. [250] (2010) O’Connell [251] (2010)	High performance military aircraft.	To design and optimize an integrated power and thermal management systems that are insensitive to design cycle uncertainty.	Avionics, oil.	Bleed, ram, and bypass air, and fuel.	The robust optimization has identified that the engine fan air temperature and the avionics thermal load are dominant noise factors and the compressor pressure ratio and the RFHX area are the dominate control factors.

Takahashi [252] (2010)	Military aircraft/ transport aircraft with wing mounted or fuselage mounted engines.	To explore some aspects of the multi-disciplinary consequences of an aircraft with integrated power and thermal management system.	Batteries, electric generators.	Fuel and ram air.	The main conclusion is that the effect of loads and losses upon airframe performance is very context dependent. For instance, if the designer sizes the aircraft for minimum fuel burn, the priorities would be different from when the aircraft will be sized for minimum thrust/weight ratio.
Lui and Dooley [253] (2013) Dooley et al. [254] (2013)	Tactical military aircraft.	To propose a potential architecture for thermal management system of more-electric aircraft.	Engine start, primary power generation system, secondary power generation system, ECS, anti-ice, flight control actuation, utility actuation, pressurization.	Ram air, fuel, and fan duct air.	The proposed architecture that utilizes energy recovery and integration principles is able to address the challenges on the power generating system. It also could reduce the overall system weight and installation volume.
Roberts and Decker [255] (2013), Roberts and Eastbourn [256] (2014), Roberts et al. [257] (2016) See also Table 10.	High performance military aircraft.	To develop a dynamic vehicle level tip-to-tail (T2T) model for electrical and thermal management system.	Engine thermal loads, FADEC, and generators.	Fuel and bleed air.	Quantitative gains in fuel savings are identified for different approaches in power take-off and controlling the thermal management system.
Abolmoali et al. [258] (2014)	A modern fighter.	To propose a reconfiguration of the closed-loop air cycle system for a modern fighter as an open-loop gas generator cycle operating interchangeably between refrigeration and auxiliary power modes.	Gas turbine heat loads.	Fuel or air.	The simulation results illustrate that the current hardware only partially supports desired power generation levels at sea level static conditions.
Donovan et al. [128], [225] (2015-2016)	See entries in Table 4 and Table 8.				
Kim et al. [259] (2018)	A 150-passenger turbo-electric distributed propulsion (TeDP) aircraft.	To presents an integrated approach to analyse power distribution and thermal management components performance at the aircraft system level	Generators, rectifiers, inverters, and electric motor.	Ram air and fuel with recirculation.	Three potential thermal management system architecture concepts are proposed for megawatt scale TeDP. It is shown that advances in TMS is more urgent for MW-class TeDP aircraft than advances in power distribution.
Koeln et al. [260] (2019)	Assumed military/ fighter.	To develop a hierarchical model predictive control (MPC) approach for energy management of 'aircraft electro-thermal systems'. The PTMS	Electrical generators, power electronics, batteries, ECS, etc.	Ram air, fan air, and fuel (which is cooled by a VCS system).	Hardware-in-the-loop experimentation showed that the MPC enables better energy efficiency and constraint satisfaction, as compared with a baseline controller.

		provides electricity for engine start, auxiliary power, and emergency power. It also provides cooling for electronics and drives the ECS.			
Torres and McCarthy [261] (2020)	Fighter.	To present the (United States) Air Force Research Laboratory's multidisciplinary design optimisation tool for aircraft design. This paper focuses on the PTMS development capabilities and demonstrates the use of the tool to perform sensitivity studies for the PTMS.	Advanced electronics (up to 150 kW); mission systems; utility systems.	Ram air and fuel.	The heat exchanger effectiveness and turbomachinery efficiency were shown to have strong interdependencies within the systems architecture and affect weight and volume. The FTMS sensitivity study demonstrated how the different PTMS capacities and large transient loads affect thermal management.
Payne et al. [200] (2020)	Unspecified (high-speed [Mach > 3.0] aircraft, assumed military).	To investigate computationally and experimentally the use of a multi-mode water-based Rankine cycle for power generation and cooling.	Aerodynamic heating, engine, and electrical systems.	Fuel (cooled by the Rankine cycle, which, in turn, generates power with steam).	A steady state power extraction of 230 W was achieved. The experimental system was also able to remove 10.7 kW from the hot oil loop – similar to a typical aircraft cooling fluid.
Abolmoali et al. [215] (2020)	See entry in Table 7.				

8.6 Supersonic transport aircraft

Recent advances in aerodynamics, materials, and acoustics technology have led the aerospace industry to revisit its negative conclusions regarding the economic feasibility of supersonic transport (SST) aircraft [262], [263]. The result is that many companies, industry observers, and academics now believe that there are SST markets that can be viably tapped.

However, to bring SSTs successfully to fruition again, many technical challenges will need to be overcome. One of the most pressing of these is thermal management. Providing adequate thermal management for supersonic flight is exceedingly difficult because of aerodynamic heating and high thrust demands [262], [264]. These challenges are more pronounced on transport aircraft (as opposed to, for example, tactical military aircraft), because of prolonged flight at supersonic speeds and the need to provide cooling for a relatively large cabin.

Sufficient thermal management has of course been successfully performed on previous SSTs – the Aérospatiale/British Aircraft Corporation Concorde and Tupolev Tu-144. However, there are several reasons to revisit and improve upon the thermal management systems that these aircraft employed. These are as follows:

- Thermal management systems can adversely affect aircraft performance. To ensure future SSTs are competitive, they will have to be as fuel-efficient as possible. The negative impact of the TMS on performance will therefore need to be minimised. This will most likely require novel techniques and technologies, as well as an integrated systems-level approach to the design of the TMS.
- Certification requirements for civil transport aircraft have become significantly more stringent since the development of the Concorde. Many TMS design, manufacturing, and operational aspects may therefore need to be amended.

- New SSTs will likely employ new airframe systems, especially more-electric technology. This may increase the magnitude and affect the location of heat loads. An expected increase in the use of avionics will also lead to higher heat loads.
- Significant work has been undertaken over the past 30 years to enhance thermal management on military aircraft. Many of the developments that resulted from this work could perhaps be exploited on future SSTs and should be explored.

The technical challenges related to thermal management on SSTs are as follows:

- *Aerodynamic heating.* SSTs usually cruise at altitudes of between 55,000 ft and 60,000 ft, where, as can be seen from Figure 5, the outside air temperature can be very low (between -86°C and -37°C). However, despite these low temperatures, aeroheating becomes problematic at supersonic speeds. For example, an SST flying at Mach 2.0 at a cruise altitude of 60,000 ft will experience a temperature of almost 117°C at its leading edges and around 100°C on the rest of its airframe exposed to ambient air. On a 1% hot day, these temperatures may be as high as 152°C and 133°C, respectively. Such temperatures pose severe challenges, such as:
 - *Structural implications.* The high temperatures caused by aeroheating can have several adverse effects on the structure of the aircraft. The most well-known of these is that many typical airframe materials will experience thermal expansion. This can induce mechanical stresses and lengthen large airframe components by several centimetres. These effects must be catered for in the design, operation, and maintenance of the airframe.
 - *Implications for cooling.* Because the temperature of cooling air ingested and on the skin of the aircraft is raised by aeroheating, the effectiveness of the air as a heat sink is diminished. Indeed, at supersonic speeds, the effectiveness is substantially reduced, and, in a number of cases, the air becomes a heat source. For example, in addition to the heating from occupants, systems, and solar heating, at supersonic speeds the cabin also receives heat from aeroheating. This adds additional cooling loads to the air conditioning packs, which themselves must be cooled by atmospheric air ingested through ram air ducts. The lower heat sink effectiveness of atmospheric air at supersonic speeds usually implies an increase in the reliance on fuel as a heat sink. This has important implications for the design of the fuel system, as well as for safety and certification. It should be noted that aeroheating could also cause heat to be transported from the air to the fuel via the airframe structure. This will slowly increase the temperature of the fuel, which would reduce its effectiveness as a heat sink as well and further compounds the cooling challenges encountered with supersonic flight.
- *High thrust requirements.* To overcome wave drag experienced at transonic and supersonic speeds, supersonic aircraft generally require comparatively higher thrust than subsonic aircraft. This essentially means that they have larger engine volume per volume of aircraft, which results in there being more waste heat per volume that has to be removed.

In addressing these challenges, much can be learned from the thermal management approaches employed on the British Aircraft Corporation/Aérospatiale Concorde. Aeroheating caused the fuselage of the Concorde to lengthen by about 20 cm during supersonic flight [265]. It also meant that using ambient air for cooling was severely restricted, resulting in fuel being heavily relied upon for thermal management. However, ram air was used in the primary and secondary air-air heat exchangers in the air-conditioning system. The fuel system was exceedingly complex compared with those on subsonic transports. In its thermal management role, the fuel system had to provide

cooling for the air-conditioning system, hydraulics, engine gearbox lubrication, and Integrated Drive Generator (IDG) oil [127]. When the mass flow rate required for cooling exceeded that required for combustion, the excess fuel was recirculated back to the feed tank. The temperature of the returned fuel could exceed 120 °C, which necessitated a pressure-holding valve to be installed in the feed tank to prevent boiling [127]. The combination of aeroheating and hot fuel recirculation resulted in very high temperatures in the fuel tanks, which necessitated the use of special, high-temperature pumps [127].

The fuel system for a modern SST would have to adhere to more stringent certification requirements, especially pertaining to flammability exposure. In particular, it is expected that inerting would be required for all tanks [127].

The example of the Concorde shows that sufficient thermal management can be provided for SSTs. However, as stated before in this section, for new designs, more efficient and lightweight systems will be required to ensure that the impact on performance is at a minimum.

8.7 Integrated thermal management modelling and simulation approaches

As discussed in Section 7.3, there may be many benefits to following an integrated systems approach to developing thermal management systems. However, espousing this approach comes with several potential difficulties. These include greater complexity, the involvement of experts from many more disciplines at ever-earlier stages of the design, and the need for sophisticated control strategies. These challenges have proved to be a strong impetus for the development of several computational methods and tools for the design and simulation of integrated thermal management systems. Several of these are summarised in Table 10.

Many of these methods and tools focus on simulating and assessing the transport of energy between different systems (including fuel) on the aircraft and the overall impact on performance that incorporating a thermal management system could introduce (e.g., [14], [255], [266]–[271]). Some allow uncertainty or parameter sensitivity to be assessed, while others enable automatic or interactive generation of TMS architectures (e.g., [14], [148], [272]–[275]). Integrating interdisciplinary tools, such as gas turbine modelling software, is essential and are described in much of the presented research (see for example [268], [276]). Others focus on allowing fast simulation with high-fidelity model results [277]–[279], using, for example, surrogate models. Some of the studies focus specifically on devising/simulating control strategies [197], [269], [280]. In fact, many of the studies in Table 10 present tools/methods that have more than one of these capabilities. Finally, some of the studies are devoted specifically to analysis tools for certain type of aircraft, such as electrified propulsion aircraft [205], [210], [281], [282], or specific types of TMS, such as power and thermal management systems [261] (see also Section 8.4).

It is suggested that future research on TMS tools/methods be focused on improving computational speed and flexibility. Knowledge-based engineering [283], [284] (KBE) could also be employed to create tools that enable more architectures to be studied rapidly, while allowing physical integration to be investigated. It is deemed that KBE would be especially useful for automatically generating thermal models for different architectures. Further integration of TMS methods/tools with toolsets that simulate other systems is also necessary. Tools that combine conceptual aircraft sizing with TMS sizing will also be beneficial, especially for military aircraft and novel concepts for civil transport aircraft, such as electrified propulsion transport aircraft.

Table 10: Studies on methods and tools for the modelling and simulation of aircraft thermal management systems.

Study	Name or description	Purpose and main capabilities	Conclusions
-------	---------------------	-------------------------------	-------------

Fischer et al. [266] (2005)	'Distributed Analysis Modelling Environment' (DAME).	DAME is a "server system capable of allowing remote system integration modelling". It incorporates Model Engineer (written in Visual Basic) for fuel thermal management modelling. It was tested and verified by applying it to design a TMS for a military long-range air vehicle system. This involved modelling of engine, airframe, power and thermal management, and fuel systems.	Enabled trade studies for different TMS configurations allowing range and performance to be maximised.
McCarthy et al. [148] (2008)	Modular systems level TMS analysis tool.	A modular approach to thermal system simulation, developed in MATLAB/Simulink. Models can be integrated and changed to define a range of architectures. Case study results focused on fuel TMS and the ECS.	The tool provides increased prediction capability of worst-case thermal management sizing conditions. Due to the modular structure, more advanced component models can be integrated.
Reeve et al. [285] (2008)	Holistic Evaluation of Aircraft Thermal Systems (HEATS).	A probabilistic thermal modelling approach. Thermal system constraints and requirements defined through probability distributions and selected via Monte Carlo methods.	A case study of two engine fuel-feed system architectures showed that probabilistic inputs could highlight uncertainty in performance results between architectures.
Maser et al. [276] (2009)	Transient simulation of propulsion and thermal management systems.	An integrated simulation model of transient behaviours in a turboshaft engine, electric generator, power electronics, and TMS using NPSS [211] and Simulink.	An effective estimation of thermal requirements is possible through combined electrical and propulsion systems simulation.
Bodden et al. [286] (2010)	integrated electrical/thermal management systems simulation and optimization.	To develop a MATLAB/Simulink/SimPowerSystems based toolbox for rapid modelling, simulation, and optimization of thermal and electrical subsystems.	Developing such an integrated toolbox will eliminate the need to execute both thermal management and electrical power systems at the highest rate by incorporating Simulink rate transition blocks that allow each subsystem to be executed at its appropriate time step.
German et al. [273] (2011)	Interactive visualisation for assessing aircraft TMS modelling approaches.	Integrated TMS steady state modelling for a range of parameters in a design of experiment (DOE) approach, enabling interactive visualisation.	The architecture included engine, fuel, bleed air, and separate refrigeration systems. The visualization via interactive parallel coordinate plots is shown to be effective.
Roberts and Decker [255] (2013), Roberts et al. [256], [270]; (2011, 2014) Donovan et al. [128], [225]; (2015, 2016). See also Table 4, Table 8, and Table 9.	Tip-to-Tail Modelling and Simulation (T2T M&S).	To simulate air vehicle system, propulsion system, adaptive power thermal management system, fuel thermal management system, electrical system and actuator system.	The T2T M&S tool is able to capture and quantify the energy exchanges throughout the aircraft.
Heltzel et al. [277] (2012)	Rapid access to high-resolution thermal/fluid component modelling.	Three-dimensional conjugate CFD calculations of heat exchanger cores with a fitted meta-model for system simulation applications.	A generic fuel TMS simulation of a tactical aircraft was conducted for a range of heat exchanger core configurations.
Heltzel et al. [287] (2012)	Thermal capacity algorithm (TCA).	A combination of predictive and aircraft sensor information is fused to provide remaining thermal capacity information to pilots.	The thermal capacity value is effectively displayed by including predicted remaining and current actual values. Pilots can make decisions about remaining mission segments with this information.
Miller et al. [278] (2012)	"Tip-to-Tail" (T2T) modelling and simulation (M&S) additions.	A transient-response surrogate modelling technique for thermal analysis of integrated aircraft system architectures.	Several surrogate-modelling approaches were tested. A feed forward neural network was shown to be most effective in estimating transient temperature responses.
Del Valle et al. [288] (2014)	Dynamic simulation for the TMS design.	A dynamic simulation approach for thermal systems, including a detailed treatment of environmental conditions.	The case study focused on the TMS of avionics components through a vapour cycle cooling system. Overall, the

			benefit of dynamic models during the design process is stressed.
Schlabe et al. [267] (2014)	Model-based thermal management function and design process.	The SFC and drag optimized control of a new ECS TMS is presented, using thermo-fluid simulations in Modelica.	The benefit of model-based thermal simulation in determining control of thermal architectures with multiple operational modes was highlighted.
Brinson et al. [268] (2014)	Preliminary Optimized Vehicle Integration Design Enabler Tool (PREOVIDE).	The work approaches system thermal modelling through a modular, component library-based approach, with coupling to the NPSS engine simulator.	No case study simulation results were presented. Work is ongoing to encourage the use of thermal simulation models during subsystem development.
Doman [4] (2015)	Rapid mission planning for aircraft thermal management.	To enable prediction of fuel temperatures at different points in a mission. This was done by finding analytical solutions to differential equations describing the evolution of the fuel temperature.	Several analytical solutions were obtained. The method can be used for mission planning with thermal management taken in consideration, or as a 'thermal reserve' gauge for the pilot.
Perullo et al. [289] (2015); Gladin et al. [282] (2017); Trawick et al. [210] (2017).	Georgia Tech Hybrid Electric Analysis Tool (GT-HEAT)	Developed for hybrid electric aircraft, GT-HEAT contains TMS models which are integrated into the NPSS program [211]. The TMS model features the following: <ul style="list-style-type: none"> • Heat exchangers for each of the independent heat sources (except for the battery). These are used to transfer heat to an air stream. • Models for cooling of electric drive machines, gearboxes inverters, batteries. • Temperature control algorithms. • A special ram air-cooling system for the batteries. 	The integrated modelling enables better understanding of the technology and design trade-offs of highly integrated future aircraft.
Deppen et al. [280] (2016)	AFRL Transient Thermal Management Optimization (ATTMO) with model predictive control (MPC).	An experimental and simulation study of the fuel TMS for tactical aircraft is presented, with a focus on control strategies.	The model predictive control approach outperforms other reactive control strategies and leads to a lower flow rate requirements and fewer temperature constrain violations.
Jain and Hency [269] (2016)	Objective function design for enhancing fuel thermal management.	Multi-objective control design of fuel TMS with thermodynamics-based objective functions. Minimisation of exergy destruction was used to determine optimal use of fuel as heat sink.	The exergy-based approach provides flexibility (enabling "plug and play") and enables "inefficiencies in the system to be automatically defined and quantified at the component level using a common metric." This enables trade-offs, even down to component-level.
Pollock et al. [197] (2016) See also Table 6.	A systematic approach for designing model predictive control for aircraft VCS.	Advanced modelling and simulation software is used (implemented in MATLAB Simulink and Thermosys), enabling VCS control design and validation to be accelerated.	The control strategy developed using the proposed method was shown to have encouraging improvements over conventional PI-based control.
Van Heerden et al. [14], [82] (2019,2020)	Framework for integrated dynamic thermal simulation of future civil transport aircraft.	A flexible MATLAB Simulink model for overall integrated thermal management system simulation on airliners. Models for the performance and thermal behaviour of all major airframe systems are provided, together with detailed engine performance and fuel thermal behaviour models.	The tool enables the impact of different thermal architectures on overall aircraft performance to be analysed swiftly. The wing thermal modelling approach enables different fuel tank arrangement and fuel system architectures to be easily incorporated. The framework was demonstrated on ultra-high bypass geared turbofan aircraft.
Raczkowski et al. [274] (2020)	Vehicle Systems Model Integration (VSMI) framework.	A co-simulation approach for aircraft subsystem modelling in multiple domains, such as fluid, mechanical, and thermal. The co-simulation approach allows for variable time step sizes between subsystem models. It also facilitates rapid studies of changes in architectures and allows for inclusion of proprietary black-box models.	Co-simulation can speed up simulations when multiple, high-fidelity models are used. Communication data overheads between models have to be managed.
Herber et al. [272] (2020)	TMS graph-based architecting.	A graph-based approach to define system architecture concepts. This allows for an enumeration of architecture alternatives, and an automated generation of thermal system simulation models.	32,612 TMS architectures were simulated and ranked for an unmanned aerial vehicle (UAV) equipped with ACM-cooled flight control and radar system, according to temperature performance metrics.

Yeu [290] (2020)	Control Volume approach to establish a transient thermal limit.	Rather than a constant thermal limit, the approach enables a dynamic temperature profile limit to be generated via a control volume method.	The approach enables brief temperature violations that do not constitute system failure to be allowed during operation, allowing for smaller TMSs.
Bell and Litt [281] (2020)	Electrical Modelling and Thermal Analysis Toolbox (EMTAT) – an open-source tool for modelling and simulating electrified aircraft propulsion systems.	The tool consists of several Simulink libraries that contain modelling and simulation tools to aide in the “control design, analysis, evaluation, and virtual testing of electrified aircraft propulsion concepts”.	The simplified models allow for fast, yet accurate dynamics calculations. The tool can be used to model a large variety of electrified propulsion systems.
Van Zwieten et al. [279] (2020)	Transient surrogate modelling for thermal management systems	The approach consists of a 6-step methodology for creating surrogate models, which employs design-of-experiments techniques for appropriate design space sampling, artificial neural networks, and state-space modelling.	It was shown that the methodology produced rapid and acceptable TMS estimates, with errors of less than 5% for most of the mission of an example military aircraft.
Torres and McCarthy [261] (2020) See also Table 9.	US Air Force Research Laboratory power and thermal management module of the ‘Expanded Multidisciplinary Design Optimization (MDO) for Effectiveness based Design Technologies’ (EXPEDITE [291]).	Integrated PTMS design tool for fighter aircraft. System component simulation in Simulink combined with CAD modelling for physical installation analysis.	It was demonstrated how sensitivity analyses using the module enable flexibility and MDO opportunities when developing PTMS systems.
Roumeliotis et al. [271] (2020) See also Table 4.	Integrated vehicle, propulsion, and fuel-oil system simulation framework for hybrid electric rotorcraft.	To assess the cooling capability of the fuel-oil system. The framework is developed in the Siemens Simcenter AMESIM software and enables studying the behaviour of the combined airframe, propulsion, and fuel-oil system.	The model enabled different missions, different levels of hybridization, and alternative power management strategies to be investigated. It highlighted the cooling capability limitations of existing fuel-oil systems on rotorcraft.
Shi et al. [275] (2021)	Systematic methodology for populating the aircraft TMS “architecture space”.	The authors proposed a behaviour-based backtracking methodology, which could be used to populate the “architecture space” with “both intuitive and non-intuitive architectures.” This was applied on a combined ECS, fuel TMS, and further federalised TMS subsystems concept.	The proposed methodology was shown to be able to populate the architecture space with both intuitive and non-intuitive TMS architectures. The number of these generated architectures was much larger than pre-selected ones from the existing literature.
Abolmoali et al. [292] (2021)	Sensitivity analysis for the design of aircraft thermal management and power systems.	The method is based on the Sobol’ variance-based approach for sensitivity analysis.	It was shown that the use of the Sobol’ method was suitable for the example problems. The results highlighted non-negligible interactions between input factors in the example applications.

9. Conclusions

In this review, the recent literature on aircraft thermal management was scrutinized to identify and collate the main future challenges and opportunities in this sphere for both military and civil aircraft. These challenges and opportunities were presented in accordance with a classification of all the major aspects involved in thermal management systems. These are heat sources (which are not a part of the thermal management system itself but must be considered nonetheless), heat acquisition mechanisms, thermal transport, and heat rejection to the terminal heat sinks.

The heat sources discussed include combustion engines, electrical machines, batteries, electrical distribution and consumer equipment, flight control actuators, the payload, environmental control systems, and so forth. Heat acquisition mechanisms are the means by which heat is collected from the heat sources, and include conduction, convective cooling (with appropriate enhancement via fins, pins, etc.), the use of cold plates for electrical equipment, spray or impingement cooling with/without vaporisation, and so forth.

The thermal transport systems comprise the cooling loops and thermodynamic cycles that move the heat from the source to the sinks over potentially large distances. Several traditional, non-traditional, and new thermal transport concepts were covered, such as simple cooling loops (using air, fuel, dielectric fluids, and glycol-water mixtures), refrigeration cycles (including vapour compression, vapour absorption, air-standard, thermoacoustic refrigeration, and transcritical cycles), and cycles producing useful work (Rankine cycles, organic Rankine cycles, and thermoacoustic heat engines).

Heat rejection to the aircraft terminal heat sinks involves the transfer of the waste heat to its final destination. This could be atmospheric air, fuel, the aircraft structure, and energy conversion and storage sinks.

In addition, several topics of particular priority in aircraft thermal management research were discussed in detail. These were thermal management for electrified propulsion aircraft, ultra-high bypass ratio geared turbfans, and high power airborne military systems; environmental control systems; power and thermal management systems; thermal management on supersonic transport aircraft; and novel modelling and simulation processes and tools for thermal management.

Summary of future challenges and opportunities

The challenges and opportunities identified for the aforementioned topics are summarised in the tables below.

Table 11: General challenges and opportunities in aircraft thermal management systemes.

Topic	Challenges	Opportunities
Heat sources	<ul style="list-style-type: none"> • In general, the number of aircraft heat sources, as well as the magnitude of waste heat produced, are increasing. • The nature of the heat sources is also changing, with many sources producing low-grade waste heat (i.e., at low temperatures), and/or the heat is not easily removed from the aircraft. • These challenges significantly increase the burden on thermal management systems. 	<ul style="list-style-type: none"> • The most obvious (but also difficult) research avenue is to improve the efficiency of the heat sources. This will lower the amount of waste heat produced, which would lessen the burden on any required TMS. • It should also always be explored whether beneficial use could be made of waste heat produced, to optimise overall aircraft energy management. For example, useful work could be produced, or the heat may be transported to where it is needed (such as for anti/de-icing).
Heat acquisition	<ul style="list-style-type: none"> • The increase in waste heat magnitude and flux are becoming more challenging for traditional heat acquisition means. • Low-grade heat sources are particularly problematic, as the temperature at which heat needs to be rejected from the source could be lower than traditionally available heat sinks. 	<ul style="list-style-type: none"> • More effective heat transfer approaches for heat acquisition should be explored. Besides improving conduction and convection approaches via novel heat transfer surface geometries and/or fluids, non-traditional approaches, such as spray, evaporative, or impingement cooling could also be incorporated or expanded for many applications. • Improvements in manufacturing (especially in additive manufacturing and brazing techniques) could enable many novel heat transfer enhancing geometries. • Much opportunity exists for investigating liquid cooling as an alternative to air-cooling. However, complexity, mass, reliability, and certification implications need to be considered. • Novel fluids, such as nanofluids, and additives are providing many opportunities for improving heat acquisition. These should be investigated to assess their potential benefits for aviation. • The integration of novel heat acquisition mechanisms with new thermal transport system architectures or heat sink options presents particularly promising avenues for future research.
Thermal transport	<ul style="list-style-type: none"> • Continuous challenges involving thermal transport systems and their constituent 	<ul style="list-style-type: none"> • Opportunities related to thermal transport components:

	<p>components revolve around efficiency, mass, power offtakes (from the aircraft powerplant), and drag elicited. These all directly impact the performance of the aircraft.</p> <ul style="list-style-type: none"> • Other significant challenges relate to cost, safety, maintainability, reliability, and certification. • More integrated approaches are promising, as they may increase overall efficiency. However, they pose the following challenges: <ul style="list-style-type: none"> ○ <i>Higher complexity than federalised systems.</i> In integrated systems, there are many potential interrelationships between the different elements of the system, as well as with the overall aircraft. Overall behaviour could be substantially more difficult to predict than with federalised systems. ○ <i>Design challenges.</i> Because of the multidisciplinary nature of highly integrated systems, more development time and cost may need to be invested up front. ○ <i>Safety and certification.</i> The interconnected nature and potential for common mode failures could lead to concerns about safety. Certification might be more challenging. ○ <i>Potential difficulties in upgradeability and family design.</i> Highly integrated systems can often be difficult to upgrade or redesign, as performing a change to one component may lead to changes to many other components [206]. Similar challenges could be faced when developing a family of aircraft. ○ <i>Control strategies.</i> Integrated systems often need elaborate control strategies, which could be difficult to develop, because of the difficulty in predicting the behaviour of these systems across the many possible conditions that they may face. 	<ul style="list-style-type: none"> ○ Research avenues for heat exchangers include: <ul style="list-style-type: none"> ▪ The development of new external geometries for a better fit in tight or irregular volumes. ▪ Enhancing heat transfer while limiting pressure drops. Further development in, for example, the use of microchannels, or other new heat transfer surface geometries, would be particularly useful. It is important that the fluid dynamics and heat transfer behaviour of any new geometries be characterised to enable these to be exploited. ▪ Future work in design methods could involve enabling more fin and overall geometries to be considered in a computationally inexpensive manner. Methods enabling more detailed analysis of the integration with the larger TMS are also needed. ▪ Manufacturing developments are especially important for heat exchangers and further developments in additive manufacturing and brazing techniques would, in particular, enable novel geometries to be exploited. ○ Cold plates are similar to heat exchangers and research opportunities related to them are therefore comparable. ○ Developments in passive components, such as heat pipes, thermosyphons, and vapour chambers present many opportunities for studying the potential benefits/pitfalls of using these on aircraft. ○ Opportunities in thermal transport fluids include investigation of the most suitable fluids for different applications, increasing cooling effectiveness, investigating the use of additives, and the use of specialised nanofluids. • Much opportunity exists for expanding the use of non-traditional and new cooling cycles on aircraft. In particular, further studies into the use of vapour-compression, vapour absorption, transcritical refrigeration, and thermoacoustic refrigeration cycles are needed for thermal lift purposes. The Rankine and organic Rankine cycles, along with thermoacoustic heat engines could be further investigated for obtaining useful work from waste heat. Particularly necessary is the investigation of the impact of these solutions on aircraft level performance, operations, and certification. • For integrated thermal transport systems, research avenues include the study of more architectures for different aircraft types, the integration of more systems for further optimisation, and methods and tools to analyse and develop novel architectures, simulate performance, and novel control strategies.
Heat rejection and terminal heat sinks	<ul style="list-style-type: none"> • Heat rejection is the ‘inverse’ of heat acquisition and therefore has the same inherent challenges (see entries above). • Challenges in using (atmospheric) air as a heat sink: <ul style="list-style-type: none"> ○ Ram air systems cause drag and add mass. ○ Bleeding engine fan air or inserting a heat exchanger in the fan stream produces a pressure drop, which leads to an increase in specific fuel consumption. Other challenges relate to the integration of fan air cooling systems into the engine where there are space constraints. • Challenges related to using fuel as a heat sink: <ul style="list-style-type: none"> ○ Safety concerns associated with high fuel temperatures. Flammability exposure must be limited. ○ Fuel at high temperatures destabilises and undergoes coking, which damages components. 	<ul style="list-style-type: none"> • Opportunities related to heat rejection means are the same as for heat acquisition (see entries above), as rejection is the ‘inverse’ of heat acquisition. • For air cooling techniques, the focus is especially on improving heat exchanger performance (for both ram and engine fan air cooling systems). In military aircraft, developing more options for using low stage fan air without breaching space constraints or affecting performance too severely is a priority. The use of the third stream on variable cycle engines for supersonic aircraft is another interesting avenue for further work. • The use of skin heat exchangers seems promising and could be investigated further for many specific aircraft applications. The study of different architectures and heat transfer

	<ul style="list-style-type: none"> ○ If fuel reaches its maximum allowable temperature, the aircraft has reached a ‘thermal endurance’ limit. This places restrictions on overall aircraft performance. ● Novel heat sinks, such as thermoelectric heat sinks, phase change materials, caloric materials, vortex tubes, and other conversion/storage sinks may face many efficiency, certification, maintainability, and reliability hurdles. 	<p>enhancement mechanisms. Studying how skin heat exchangers could affect the boundary layer is imperative.</p> <ul style="list-style-type: none"> ● Different strategies for maximising the capacity of fuel as a heat sink should be examined further. This would reduce reliance on air as a coolant. Some avenues to explore include: <ul style="list-style-type: none"> ○ Reducing fuel system component heat loads (especially from fuel pumps). ○ New recirculation strategies. ○ The use of additives to increase allowable temperature limits. ○ The use of fuels specifically designed for higher temperatures. ● The thermal management implications of using sustainable fuels present many opportunities for further study. ● Despite the challenges involved with novel heat sinks (described left), there is abundant opportunity to study their feasibility on different aircraft applications. Means to address the challenges involved should be explored.
--	---	--

Table 12: Challenges and opportunities in topics of priority in aircraft thermal management.

Topic	Challenges	Opportunities
Electrified propulsion aircraft (EPA)	<ul style="list-style-type: none"> ● Waste heat produced by electric components in the propulsion transmission is not exhausted away from aircraft, as in gas turbines. ● These heat loads may be of the megawatt order and have high magnitudes of heat flux. ● The waste heat is ‘low grade’ (of ‘low quality’), which means that the heat must be removed at low source temperatures. This poses constraints in terms of what heat sinks could be used and may elicit the use of ‘thermal lifts’ (refrigeration cycles). ● Because EPA would need less fuel, there is less fuel available to reject heat to. In full electric aircraft, there will be no fuel to reject heat to. ● Many large hybrid EPA are envisaged to use cryogenic fuels, which pose many technical challenges. 	<ul style="list-style-type: none"> ● The impact of TMS architectures on overall aircraft efficiency could be explored more extensively for given aircraft concepts. Physical integration should also be studied in more depth. ● The use of fuel as a heat sink on EPA could be studied in more depth. If fuel is used for cooling in a careful and optimised manner (such as using controlled recirculation to the tanks), the negative effects of the TMS may be reduced. ● Performing integration with other airframe systems (such as environmental control) may decrease overall mass, power consumption, and drag, and should be investigated. ● The use of non-traditional thermodynamic cycles (see Section 7.2) should be investigated to determine if these could reduce the performance impact of the TMS on the aircraft. Such studies would also need to involve the associated certification, safety, and operational aspects. ● The use of novel heat sinks, such as those listed in Section 6 should be explored in more depth. ● Recent developments in military aircraft thermal management systems could be explored to determine if they could be exploited for EPA.
Ultra-high bypass ratio geared turbofan (UHBR GTF) aircraft	<ul style="list-style-type: none"> ● The waste heat produced in UHBR GTFs is projected to be significant (up to 275 kW per engine for an Airbus A320-sized UHBR GTF aircraft [18]). This heat is not expelled along with the exhaust gases and require dedicated cooling. ● This problem will be exacerbated by projected higher engine core temperatures, reduced engine core ventilation, as well as less space for cooling equipment. ● The oil cooling mechanism will probably rely significantly on air from the bypass stream. This poses challenges regarding heat exchanger design, especially with respect to ensuring minimum pressure loss (which would lead to a reduction in efficiency). 	<ul style="list-style-type: none"> ● As with EPA, the impact of TMS architecture on overall aircraft efficiency and physical integration could be explored in more depth. ● Integrating other airframe systems with the propulsion TMS could be investigated. As for EPA TMSs, performing such integration may decrease impact on overall aircraft performance. ● It should be explored whether the waste heat from UHBR GTF components could be used for beneficial purposes, to increase overall energy efficiency. ● As with EPA TMSs, the use of non-traditional and novel thermodynamic cycles and heat sinks could be explored, along with the associated certification, safety, and operational aspects. ● The exploitation of developments in military aircraft thermal management systems could again be explored.
High power military systems (directed energy weapons [DEWs])	<ul style="list-style-type: none"> ● DEWs consume very high levels of power (in the MW range) over very short periods of time, producing pulses of immense waste heat magnitude and flux. 	<ul style="list-style-type: none"> ● Important avenues of research on DEW thermal management include: <ul style="list-style-type: none"> ○ The development of more effective, lightweight heat acquisition means.

		<ul style="list-style-type: none"> ○ Thermal storage means are possibly the most feasible means of managing the heat from DEWs. There is much opportunity in identifying and optimising the most appropriate storage means. ○ Means of exploiting the waste heat from DEWs for beneficial purposes onboard could be explored in more depth.
Environmental control systems (ECS)	<ul style="list-style-type: none"> ● The ECS can be an exceptionally large onboard secondary power consumer (often by far the biggest on civil aircraft). It could therefore have considerable impact on overall aircraft efficiency. ● ECS components also produce waste heat, which could have a negative effect on surrounding systems, such as the fuel tanks. Power electronics and motors on more electric ECSs may need substantial cooling. ● Many onboard heat loads that are traditionally managed by the ECS, are growing in magnitude, placing higher demands on performance, which could further affect aircraft overall performance. 	<ul style="list-style-type: none"> ● Novel means for sourcing air for the ECS should be investigated further. More electric systems, where ram air is compressed with electric motors, are one option that has already been implemented on current aircraft. However, improvements and variations of this solution could be explored further to increase efficiency, reliability, and maintainability, and lower mass and cost. ● Thermal management methods using non-traditional and novel cycles (Section 7.2) and heat sinks (Section 6.4) could be explored to determine whether such solutions may offer improvements over current approaches. ● Integration with other thermal and power management systems should be explored in more depth. This has already successfully been done for military aircraft and there is much opportunity for civil applications.
Power and thermal management systems (PTMSs)	<ul style="list-style-type: none"> ● PTMSs are highly integrated systems, and therefore have the same challenges as with highly integrated systems. As discussed, these include higher complexity, design challenges arising from the strong multidisciplinary nature of such systems, difficulties in upgradeability/family design, and the provision of appropriate control strategies. ● Additionally, there may be challenges involved in operating PTMSs, such as reliability, maintainability, safety, and certification. 	<ul style="list-style-type: none"> ● More architectures and ways of combining different onboard energy systems should be investigated. ● This should be explored for more applications, such as civil transport aircraft. ● Such research would necessarily be highly interdisciplinary in nature and should ideally involve investigating solutions in parallel with the conceptual design of the aircraft. ● There is much work to do to explore the reliability, maintainability, safety, and certification implications of PTMSs.
Supersonic transport (SST) aircraft	<ul style="list-style-type: none"> ● The two main thermal management challenges associated with SSTs result from aerodynamic heating and the elevated levels of thrust required. ● Aerodynamic heating severely diminishes the heat sink capacity of ambient air. This results in fuel being heavily relied upon for cooling. ● However, because of safety and fuel destabilisation concerns, there are limits to how much heat can be added to the fuel onboard. If these limits are reached, the aircraft is considered to have reached its 'thermal endurance' limit. 	<ul style="list-style-type: none"> ● The design of the fuel system on any future SST will need great attention and care. Different means to maximise overall efficiency and thermal endurance need to be investigated (see Section 6.2). ● Reducing the cooling burden on the fuel, by using novel systems approaches, or new types of heat sinks. ● Apart from determining their efficiency and thermal endurance characteristics, proposed thermal management systems would also need to be studied carefully from the perspectives of safety, certification, reliability, maintainability, and cost.
Integrated thermal management system modelling and simulation methods and tools	<ul style="list-style-type: none"> ● New tools and methods need to account for the complexity involved in more integrated TMSs. The increased complexity means that the overall behaviour could be difficult to predict. ● The tools/methods will necessarily be highly multi/interdisciplinary in nature, which poses challenges for their development. ● The tools/methods have to simulate a wide range of operational conditions for many different possible concept architectures. Computational expense may therefore be problematic. ● Integrated systems often need elaborate control strategies, which could be challenging to develop. 	<ul style="list-style-type: none"> ● One focus should be on improving computational speed and flexibility (i.e., the ability to analyse multiple different TMS architectures). ● Knowledge-based engineering could be employed to create tools that enable more architectures to be generated and studied rapidly, while allowing physical integration to be investigated. ● Studies of further integration with toolsets that simulate other systems is necessary. ● In addition, tools that combine conceptual aircraft sizing with TMS sizing will be beneficial. ● Exergy analysis is one technique that could be used more extensively to analyse the overall behaviour of integrated TMSs.

10. Acknowledgments

This work was conducted under the Ultra High Bypass Ratio Aero Engine Thermal Systems (UHBR Thermals) Programme, funded by Meggitt PLC, as lead partner, and Innovate UK (grant No: 91855-263266).

11. References

- [1] K. E. Hinderliter, "Aircraft Thermal Management System," Patent Application: US 2017/0217592 A1, Aug. 03, 2017.
- [2] D. O. Sigthorsson, M. W. Oppenheimer, and D. B. Doman, "Aircraft thermal endurance optimization part I: Using a mixed dual tank topology and robust temperature regulation," 2019, doi: 10.2514/6.2019-1662.
- [3] D. O. Sigthorsson, M. W. Oppenheimer, and D. B. Doman, "Aircraft thermal endurance optimization part II: Using a simple dual tank topology and robust temperature regulation," 2019, doi: 10.2514/6.2019-1663.
- [4] D. B. Doman, "Rapid mission planning for aircraft thermal management," 2015, doi: 10.2514/6.2015-1076.
- [5] M. W. Oppenheimer, D. O. Sigthorsson, and D. B. Doman, "Extending aircraft thermal endurance by fuel pump sizing," in *AIAA Guidance, Navigation, and Control Conference, 2018*, 2018, no. 210039, doi: 10.2514/6.2018-0856.
- [6] D. B. Doman, "Optimal cruise altitude for aircraft thermal management," *J. Guid. Control. Dyn.*, vol. 38, no. 11, pp. 2084–2095, 2015, doi: 10.2514/1.G000845.
- [7] M. W. Oppenheimer, D. O. Sigthorsson, and D. B. Doman, "Control of fuel thermal management systems with transport delays," 2019, doi: 10.2514/6.2019-1917.
- [8] D. O. Sigthorsson, M. W. Oppenheimer, and D. B. Doman, "Aircraft thermal endurance enhancement using a dual tank configuration and temperature regulation," in *AIAA Guidance, Navigation, and Control Conference, 2018*, 2018, no. 210039, doi: 10.2514/6.2018-0612.
- [9] H. Huang, L. J. Spadaccini, and D. R. Sobel, "Fuel-cooled thermal management for advanced aeroengines," *J. Eng. Gas Turbines Power*, vol. 126, no. 2, pp. 284–293, 2004, doi: 10.1115/1.1689361.
- [10] T. Mahefkey, K. Yerkes, B. Donovan, and M. L. Ramalingam, "Thermal management challenges for future military aircraft power systems," *SAE Tech. Pap.*, 2004, doi: 10.4271/2004-01-3204.
- [11] Y. R. Lin, K. Kota, L. Chow, and Q. Leland, "Design of a thermal management system for directed energy weapons," 2009, doi: 10.2514/6.2009-4248.
- [12] B. P. Tucker, J. Homitz, and J. Messmer, "System integration of a thermal storage device for high-power-density systems," *SAE Tech. Pap.*, vol. 10, 2012, doi: 10.4271/2012-01-2189.
- [13] G. Gvozdich, P. Weise, and M. Von Spakovsky, "Invent: Study of issues involved in integrating a directed energy weapon subsystem into a high performance aircraft system," 2012, doi: 10.2514/6.2012-490.
- [14] A. S. J. van Heerden, D. M. Judt, C. P. Lawson, S. Jafari, T. Nikolaidis, and D. Bosak, "Framework for integrated dynamic thermal simulation of future civil transport aircraft,"

Jan. 2020, doi: 10.2514/6.2020-1942.

- [15] B. T. Schiltgen, J. L. Freeman, and D. W. Hall, "Aeropropulsive interaction and thermal system integration within the ECO-150: A turboelectric distributed propulsion airliner with conventional electric machines," in *16th AIAA Aviation Technology, Integration, and Operations Conference*, 2016, pp. 1–18, [Online]. Available: <https://www.scopus.com/inward/record.uri?eid=2-s2.0-84980374215&partnerID=40&md5=8f37d56620abd69e1a395dfe89848d49>.
- [16] C. E. Lents, L. W. Hardin, J. Rheume, and L. Kohlman, "Parallel Hybrid Gas-Electric Geared Turbofan Engine Conceptual Design and Benefits Analysis," Jul. 2016, doi: 10.2514/6.2016-4610.
- [17] J. W. Chapman, S. L. Schnulo, and M. P. Nitzsche, "Development of a Thermal Management System for Electrified Aircraft," in *AIAA Scitech 2020 Forum*, American Institute of Aeronautics and Astronautics, 2020.
- [18] T. Nikolaidis, S. Jafari, D. Bosak, and P. Pilidis, "Exchange Rate Analysis for Ultra High Bypass Ratio Geared Turbofan Engines," *Appl. Sci.*, vol. 10, no. 21, p. 7945, 2020.
- [19] Z. H. U. Yin Hai, P. Wei, X. U. Ruina, and P. Jiang, "Review on active thermal protection and its heat transfer for airbreathing hypersonic vehicles," *Chinese J. Aeronaut.*, vol. 31, no. 10, pp. 1929–1953, 2018.
- [20] Meggitt PLC, "£3.7m grant awarded for thermal management solutions," 2017. <https://www.meggitt.com/news/3-7-m-grant-awarded-for-thermal-management-solutions/> (accessed Mar. 24, 2021).
- [21] D. Pal and M. Severson, "Liquid cooled system for aircraft power electronics cooling," in *Proceedings of the 16th InterSociety Conference on Thermal and Thermomechanical Phenomena in Electronic Systems, ITherm 2017*, 2017, pp. 800–805, doi: 10.1109/ITHERM.2017.7992568.
- [22] International Organization for Standardization, "Standard Atmosphere, ISO 2533: 1975," 1975.
- [23] US Government Printing Office, *US standard atmosphere*, vol. 76, no. 1562. Washington, DC, USA: National Oceanic and Atmospheric Administration; National Aeronautics and Space Administration; U.S. Air Force, 1976.
- [24] US Department of Defense, "MIL-STD-210C- Climatic information to determine design and test requirements for military systems and equipment." 1987.
- [25] US Department of Defense, "MIL-HNDB-310: Military Handbook: Global Climatic Data for Developing Military Products." 1997.
- [26] SAE International, "Definition of Commonly Used Day Types (Atmospheric Ambient Temperature Characteristics Versus Pressure Altitude), AS210," 2018.
- [27] IHS Engineering Sciences Data Unit, "ESDU Data Item 69009: Heat balance for flight vehicles.," 1969.
- [28] M. F. Ahlers, "Aircraft Thermal Management," in *Encyclopedia of Aerospace Engineering*, Wiley Online Library, 2010.
- [29] P. P. Walsh and P. Fletcher, *Gas Turbine Performance*. Wiley, 2004.
- [30] J. Kurzke, "Design and Off-Design performance of gas turbines. GasTurb 12 User Guide," Aachen, Germany, 2015.

- [31] M. Vieweg, F. Wolters, and R. G. Becker, "Comparison of a heat soakage model with turbofan transient engine data," in *Proceedings of the ASME Turbo Expo*, Aug. 2017, vol. 1, doi: 10.1115/GT2017-63461.
- [32] W. P. J. Visser and M. J. Broomhead, "GSP, a generic object-oriented gas turbine simulation environment," in *Proceedings of the ASME Turbo Expo*, Aug. 2000, vol. 1, doi: 10.1115/2000-GT-0002.
- [33] R. Martinelle, "Transient performance calculation of the Rolls-Royce/MAN Turbo RB 153 engine with special focus on heat soakage (German Aerospace Center Technical Report: No. DLR-IB-AT-KP-2017-9)," Cologne, 2017.
- [34] K. Bauerfeind, "The exact determination of the transmission behavior of turbojet engines, taking into account the transient behaviour of its components (title translated from German), Technical University of Munich," 1968.
- [35] O. Verseux and Y. Sommerer, "New challenges for engine nacelle compartments pressure and thermal loads management with aircraft engine evolution," 2014.
- [36] Q. Zhang and L. He, "Turbine blade tip aero-thermal management: Some recent advances and research outlook," *J. Glob. Power Propuls. Soc.*, vol. 1, 2017.
- [37] G. B. Bruening and W. S. Chang, "Cooled cooling air systems for turbine thermal management," in *Turbo Expo: Power for Land, Sea, and Air*, 1999, vol. 78606, p. V003T01A002.
- [38] N. Seki, N. Morioka, H. Saito, and H. Oyori, "A Study of Air/Fuel Integrated Thermal Management System," *SAE Tech. Pap.*, vol. 2015-Septe, no. September, 2015, doi: 10.4271/2015-01-2419.
- [39] N. Morioka, H. Saito, N. Takahashi, M. Seta, and H. Oyori, "Thermal management system concept with an autonomous air-cooled system," *SAE Tech. Pap.*, no. September, 2014, doi: 10.4271/2014-01-2213.
- [40] J. Sousa, L. Villafane, and G. Paniagua, "Thermal analysis and modeling of surface heat exchangers operating in the transonic regime," *Energy*, vol. 64, pp. 961–969, 2014.
- [41] M. Williams, A. Muley, J. Bolla, and H. Strumpf, "Advanced heat exchanger technology for aerospace applications," *SAE Tech. Pap.*, 2008, doi: 10.4271/2008-01-2903.
- [42] D. W. Johnson, "Lubricants for Turbine Engines," in *Recent Progress in Some Aircraft Technologies*, InTech, 2016.
- [43] U.S. Department of Defense, "MIL-PRF-23699G: LUBRICATING OIL AIRCRAFT TURBINE ENGINE," 1997. Accessed: Jul. 01, 2020. [Online]. Available: http://everyspec.com/MIL-PRF/MIL-PRF-000100-09999/MIL-PRF-7808L_5699/.
- [44] Lufthansa Technical Training, "Training Manual: A319 / A320 / A321 Part-2, Book No: A319/320/321 71-80CFM L3 e." 1999.
- [45] J.-C. Han, "Recent Studies in Turbine Blade Cooling," *Int. J. Rotating Mach.*, vol. 10, no. 6, pp. 443–457, 2004, doi: 10.1155/s1023621x04000442.
- [46] L. Xu, S. Bo, Y. Hongde, and W. Lei, "Evolution of Rolls-royce Air-cooled Turbine Blades and Feature Analysis," in *Procedia Engineering*, Jan. 2015, vol. 99, pp. 1482–1491, doi: 10.1016/j.proeng.2014.12.689.
- [47] S. Jafari, T. Nikolaidis, A. S. J. van Heerden, C. P. Lawson, and D. Bosak, "PHYSICS-BASED THERMAL MODEL FOR POWER GEARBOXES IN GEARED TURBOFAN ENGINES," 2021.

- [48] Siemens AG, “Factsheet Rekord-Motor SP260D und Extra 330LE (in German),” 2016. <https://assets.new.siemens.com/siemens/assets/api/uuid:04c7fe39-b322-417f-a3ac-7bcae1d64d50/factsheet-erstflug-weltrekordmotor-d.pdf> (accessed Mar. 29, 2021).
- [49] R. H. Jansen, C. Bowman, A. Jankovsky, R. Dyson, and J. Felder, “Overview of NASA Electrified Aircraft Propulsion Research for Large Subsonic Transports,” Jul. 2017. [Online]. Available: <https://ntrs.nasa.gov/search.jsp?R=20170006235>.
- [50] S. L. Schnulo *et al.*, “Assessment of the Impact of an Advanced Power System on a Turboelectric Single-Aisle Concept Aircraft,” in *AIAA Propulsion and Energy 2020 Forum*, 2020, p. 3548.
- [51] R. H. Jansen *et al.*, “High Efficiency Megawatt Motor Risk Reduction Activities,” in *2020 AIAA/IEEE Electric Aircraft Technologies Symposium (EATS)*, 2020, pp. 1–12.
- [52] G. Szpak, A. Smith, J. Thompson, A. Woodworth, and R. Jansen, “High Efficiency Megawatt Motor Thermal Stator Preliminary Design,” in *2020 AIAA/IEEE Electric Aircraft Technologies Symposium (EATS)*, 2020, pp. 1–27.
- [53] A. Hebala *et al.*, “Feasibility Design Study of High-Performance, High-Power-Density Propulsion Motor for Middle-Range Electric Aircraft,” in *2020 IEEE 29th International Symposium on Industrial Electronics (ISIE)*, 2020, pp. 300–306.
- [54] T. Dong, C. Zhu, F. Zhou, H. Zhang, F. Lu, and X. Zhang, “Innovated Approach of Predictive Thermal Management for High-Speed Propulsion Electric Machines in More Electric Aircraft,” *IEEE Trans. Transp. Electrif.*, vol. 6, no. 4, pp. 1551–1561, 2020.
- [55] M. D. Sumption, J. Murphy, M. Susner, and T. Haugan, “Performance metrics of electrical conductors for aerospace cryogenic motors, generators, and transmission cables,” *Cryogenics (Guildf.)*, vol. 111, p. 103171, 2020.
- [56] G. Brown, “Weights and efficiencies of electric components of a turboelectric aircraft propulsion system,” in *49th AIAA aerospace sciences meeting including the new horizons forum and aerospace exposition*, 2011, p. 225.
- [57] P. J. Masson and C. A. Luongo, “HTS machines for applications in all-electric aircraft,” in *2007 IEEE Power Engineering Society General Meeting*, 2007, pp. 1–6.
- [58] C. Pernet, “Conceptual design methods for sizing and performance of hybrid-electric transport aircraft.” Technische Universität München, 2018.
- [59] H.-J. Steiner, A. Seitz, K. Wiecek, K. Plötner, A. T. Isikveren, and M. Hornung, “Multi-disciplinary design and feasibility study of distributed propulsion systems,” in *28th International Congress of the Aeronautical Sciences*, 2012, pp. 23–28.
- [60] P. C. Vratny, P. Forsbach, A. Seitz, and M. Hornung, “Investigation of universally electric propulsion systems for transport aircraft,” in *29th Congress of the International Council of the Aeronautical Sciences*, 2014, pp. 1–13.
- [61] J. Freeman, P. Osterkamp, M. Green, A. Gibson, and B. Schiltgen, “Challenges and opportunities for electric aircraft thermal management,” *Aircr. Eng. Aerosp. Technol.*, vol. 86, no. 6, pp. 519–524, 2014, doi: 10.1108/AEAT-04-2014-0042.
- [62] R. D. Falck, J. Chin, S. L. Schnulo, J. M. Burt, and J. S. Gray, “Trajectory optimization of electric aircraft subject to subsystem thermal constraints,” in *18th AIAA/ISSMO Multidisciplinary Analysis and Optimization Conference*, 2017, p. 4002.
- [63] T. F. Tallerico *et al.*, “Outer Mold Line Cooled Electric Motors for Electric Aircraft,” in *2020 AIAA/IEEE Electric Aircraft Technologies Symposium (EATS)*, 2020, pp. 1–27.

- [64] S. Ma *et al.*, "Temperature effect and thermal impact in lithium-ion batteries: A review," *Prog. Nat. Sci. Mater. Int.*, vol. 28, no. 6, pp. 653–666, 2018, doi: <https://doi.org/10.1016/j.pnsc.2018.11.002>.
- [65] D. H. Jeon and S. M. Baek, "Thermal modeling of cylindrical lithium ion battery during discharge cycle," *Energy Convers. Manag.*, vol. 52, no. 8, pp. 2973–2981, 2011, doi: <https://doi.org/10.1016/j.enconman.2011.04.013>.
- [66] D. Bernardi, E. Pawlikowski, and J. Newman, "A General Energy Balance for Battery Systems," *J. Electrochem. Soc.*, vol. 132, no. 1, p. 5, 1985, doi: 10.1149/1.2113792.
- [67] S. Madani, E. Schaltz, and S. Knudsen Kær, "Heat Loss Measurement of Lithium Titanate Oxide Batteries under Fast Charging Conditions by Employing Isothermal Calorimeter," *Batteries*, vol. 4, no. 4, p. 59, Nov. 2018, doi: 10.3390/batteries4040059.
- [68] J. Zhang, L. Su, Z. Li, Y. Sun, and N. Wu, "The Evolution of Lithium-Ion Cell Thermal Safety with Aging Examined in a Battery Testing Calorimeter," *Batteries*, vol. 2, no. 2, p. 12, Apr. 2016, doi: 10.3390/batteries2020012.
- [69] S. Novais *et al.*, "Internal and external temperature monitoring of a li-ion battery with fiber bragg grating sensors," *Sensors (Switzerland)*, vol. 16, no. 9, Sep. 2016, doi: 10.3390/s16091394.
- [70] G. Lappin, *Alpha olefins applications handbook*. CRC press, 2014.
- [71] I. A. Hunt, Y. Zhao, Y. Patel, and G. J. Offer, "Surface cooling causes accelerated degradation compared to tab cooling for lithium-ion pouch cells," *J. Electrochem. Soc.*, vol. 163, no. 9, p. A1846, 2016.
- [72] Y. Zhao, L. B. Diaz, Y. Patel, T. Zhang, and G. J. Offer, "How to cool lithium ion batteries: optimising cell design using a thermally coupled model," *J. Electrochem. Soc.*, vol. 166, no. 13, p. A2849, 2019.
- [73] M. Macdonald, Y. Khakpour, and C. E. Lents, "Transient Cooling Approach for a Mhr Class Hybrid Electric Propulsion System Battery Pack," in *AIAA Scitech 2020 Forum*, 2020, p. 120.
- [74] S. H. Teichel *et al.*, "Design considerations for the components of electrically powered active high-lift systems in civil aircraft," *CEAS Aeronaut. J.*, vol. 6, no. 1, pp. 49–67, Aug. 2014, doi: 10.1007/s13272-014-0124-1.
- [75] A. Merkert, J. Muller, and A. Mertens, "Component design and implementation of a 60 kW full SiC traction inverter with boost converter," 2016, doi: 10.1109/ECCE.2016.7854947.
- [76] O. Kreutzer, M. März, and H. Nakata, "Full SiC DCDC-Converter with a Power Density of more than 100kW/dm³," 2014, Accessed: Jul. 01, 2020. [Online]. Available: <https://www.scientific.net/MSF.821-823.884>.
- [77] G. Chiriac, "Thermal analysis of fuses with variable cross-section fuselinks," *Electr. Power Syst. Res.*, vol. 92, pp. 73–80, Nov. 2012, doi: 10.1016/j.epsr.2012.06.010.
- [78] C. Nițucă, "Thermal analysis of electrical contacts from pantograph-catenary system for power supply of electric vehicles," *Electr. Power Syst. Res.*, vol. 96, pp. 211–217, Mar. 2013, doi: 10.1016/j.epsr.2012.11.009.
- [79] A. T. Isikveren, A. Seitz, P. C. Vratny, C. Pernet, K. O. Plötner, and M. Hornung, "Conceptual studies of universally-electric systems architectures suitable for transport aircraft," 2012.
- [80] Y. Xin, "Installation and trial operation of 35kV/12MVA HTS AC power cable," 2004.

- [81] A. Fly and R. H. Thring, "A comparison of evaporative and liquid cooling methods for fuel cell vehicles," *Int. J. Hydrogen Energy*, vol. 41, no. 32, pp. 14217–14229, 2016, doi: <https://doi.org/10.1016/j.ijhydene.2016.06.089>.
- [82] A. S. J. van Heerden, D. M. Judt, C. P. Lawson, and D. Bosak, "Effects of More Electric Systems on Fuel Tank Thermal Behaviour," 2019, [Online]. Available: <https://www.see.asso.fr/MEA2019>.
- [83] Society of Automotive Engineers. Committee AC-9 Aircraft Environmental Systems, *SAE Aerospace Applied Thermodynamics Manual*. Society of Automotive Engineers, 1969.
- [84] G. R. Gersch, "Assessment of potential benefits in utilization of advanced thermal management materials," *Int. SAMPE Electron. Conf.*, vol. 6, pp. 594–604, 1992, [Online]. Available: <https://www.scopus.com/inward/record.uri?eid=2-s2.0-0027085204&partnerID=40&md5=9ff645d35f8eb073b4d1889e3b288ece>.
- [85] J. P. Fielding and M. Vaziry, "Avionics cooling-rate trade-off modelling for ultrahigh capacity aircraft," *Proc. Inst. Mech. Eng. Part G J. Aerosp. Eng.*, vol. 211, no. 6, pp. 403–410, 1997, [Online]. Available: <https://www.scopus.com/inward/record.uri?eid=2-s2.0-0031346653&partnerID=40&md5=43cfc9573a36f0866619f90feeb420e9>.
- [86] J. Homitz, R. P. Scaringe, G. S. Cole, A. Fleming, and T. E. Michalak, "Comparative analysis of thermal management architectures to address evolving thermal requirements of aircraft systems," *SAE Tech. Pap.*, 2008, doi: 10.4271/2008-01-2905.
- [87] F. Sanchez and S. Liscouët-Hanke, "Thermal risk prediction methodology for conceptual design of aircraft equipment bays," *Aerosp. Sci. Technol.*, vol. 104, p. 105946, 2020, doi: <https://doi.org/10.1016/j.ast.2020.105946>.
- [88] D. van den Bossche, "The A380 flight control electrohydrostatic actuators, achievements and lessons learnt," in *25th International Congress of the Aeronautical Sciences*, 2006, pp. 1–8.
- [89] C. P. Lawson and J. M. Pointon, "Thermal management of electromechanical actuation on an all-electric aircraft," in *ICAS Secretariat - 26th Congress of International Council of the Aeronautical Sciences 2008, ICAS 2008*, 2008, vol. 4, pp. 1467–1477.
- [90] D. Woodburn *et al.*, "High-performance electromechanical actuator dynamic heat generation modeling," *IEEE Trans. Aerosp. Electron. Syst.*, vol. 50, no. 1, pp. 530–541, 2014, doi: 10.1109/TAES.2013.120338.
- [91] Y. Hu, D. Woodburn, Y.-R. Lin, T. Wu, L. C. Chow, and Q. Leland, "Modeling and simulation of power loss in drive unit of electromechanical actuator," *SAE Tech. Pap.*, vol. 10, 2012, doi: 10.4271/2012-01-2232.
- [92] T. J. Bland and K. D. Funke, "Advanced Cooling for High Power Electric Actuators," SAE Technical Paper, 1992.
- [93] M. G. Schneider, S. M. Thomson, T. J. Bland, and K. L. Yerkes, "Test results of reflux-cooled electromechanical actuator," *SAE Trans.*, pp. 2213–2221, 1994.
- [94] C. Dunker, R. Bornholdt, F. Thielecke, and R. Behr, "Architecture and parameter optimization for aircraft electro-hydraulic power generation and distribution systems," SAE Technical Paper, 2015.
- [95] N. Trochelmann, T. Rave, F. Thielecke, and D. Metzler, *An Investigation of Electro-Hydraulic High Efficient Power Package Configurations for a More Electric Aircraft System Architecture*. Deutsche Gesellschaft für Luft-und Raumfahrt-Lilienthal-Oberth eV, 2020.

- [96] K. Li, Z. Lv, K. Lu, and P. Yu, "Thermal-hydraulic Modeling and Simulation of the Hydraulic System based on the Electro-hydrostatic Actuator," *Procedia Eng.*, vol. 80, pp. 272–281, 2014.
- [97] J. Li, J. Xu, X. Zhang, and Y. Yin, "An estimation method of the fluid temperature for commercial aircraft hydraulic systems," in *2010 International Conference on Mechanic Automation and Control Engineering, MACE2010*, 2010, pp. 2962–2965, doi: 10.1109/MACE.2010.5536487.
- [98] D. Li, S. Dong, J. Wang, and Y. Li, "State-of-the-art and some considerations on thermal load analysis and thermal management for hydraulic system in MEA," *J. Eng.*, vol. 2018, no. 13, pp. 399–405, 2018.
- [99] W. Si, Y. Hualong, H. Dingbang, C. Hai, H. Xiping, and M. Qingtang, "Thermal analysis for hydraulic powering system of a certain type aircraft," 2018.
- [100] D. Li, S. Dong, J. Wang, and Y. Li, "Modeling and simulation of system-level temperature for airliner hydraulic system in a full flight mission profile," in *IET Conference Publications*, 2018, vol. 2018, no. CP743, pp. 338–343, [Online]. Available: <https://www.scopus.com/inward/record.uri?eid=2-s2.0-85054630445&partnerID=40&md5=4c26e5188353e8fd89cfd430dcbf7a34>.
- [101] L. Chenggong and J. Zongxia, "Calculation method for thermal-hydraulic system simulation," *J. Heat Transfer*, vol. 130, no. 8, 2008.
- [102] W. Affonso *et al.*, "Thermal Management challenges for HEA–FUTPRINT 50," in *IOP Conference Series: Materials Science and Engineering*, 2021, vol. 1024, no. 1, p. 12075.
- [103] P. E. Dewey and A. R. Vick, *An investigation of the discharge and drag characteristics of auxiliary-air outlets discharging into a transonic stream*. National Advisory Committee for Aeronautics, 1955.
- [104] C. F. Hall and F. D. Barclay, "An experimental investigation of NACA submerged inlets at high subsonic speeds I: inlets forward of the wing leading edge, NACA Report NACA-RM-A8B16," 1948.
- [105] F. W. Meredith, *Note on the Cooling of Aircraft Engines with special reference to Ethylene Glycol Radiators enclosed in Ducts*. HM Stationery Office, 1935.
- [106] M. Sielemann *et al.*, "Aircraft Fuel System Design Using 1D and 3D Methods: An Enabler for Thermal Management," SAE Technical Paper 2017-01-2039, 2017. doi: 10.4271/2017-01-2039.
- [107] J. P. Jasa, C. A. Mader, and J. R. R. A. Martins, "Trajectory optimization of a supersonic aircraft with a thermal fuel management system," 2018, doi: 10.2514/6.2018-3884.
- [108] R. W. Hitzgrath, "Improving aircraft fuel-thermal management," *SAE Tech. Pap.*, 1993, doi: 10.4271/932086.
- [109] M. Dooley, N. Lui, R. Newman, and C. Lui, "Aircraft thermal management -heat sink challenge," *SAE Tech. Pap.*, no. September, 2014, doi: 10.4271/2014-01-2193.
- [110] K. Kasim, A. Muley, M. Stoia, and F. Ladeinde, "Advanced heat transfer devices for aerospace applications," in *ASME International Mechanical Engineering Congress and Exposition, Proceedings (IMECE)*, 2017, vol. 8, doi: 10.1115/IMECE2017-72382.
- [111] B. McKay and A. Barlow, "The ultrafan engine and aircraft based thrust reversing," in *48th AIAA/ASME/SAE/ASEE Joint Propulsion Conference & Exhibit*, 2012, p. 3919.

- [112] D. M. Judt, C. P. Lawson, A. S. J. van Heerden, and D. Bosak, "Modelling of future engine and airframe integrated thermal systems concepts," 2018.
- [113] M. Corbett, "Shaft Power Extraction and Waste Heat Rejection using a Three Stream Variable Cycle Engine," *SAE Int. J. Aerosp.*, vol. 5, no. 2012-01–2167, pp. 371–385, 2012.
- [114] M. W. Corbett, "Large-scale transient loading of a three stream variable cycle engine," 2012, [Online]. Available: <https://www.scopus.com/inward/record.uri?eid=2-s2.0-84880850362&partnerID=40&md5=68eed1369911b1e1040f4773bcd34d34>.
- [115] J. G. Polihronov and A. G. Straatman, "The maximum coefficient of performance (COP) of vortex tubes," *Can. J. Phys.*, vol. 93, no. 11, pp. 1279–1282, Apr. 2015, doi: 10.1139/cjp-2015-0089.
- [116] T. Wang, C. Britcher, and P. Martin, "Surface heat exchangers for aircraft applications-A technical review and historical survey," in *37th Aerospace Sciences Meeting and Exhibit*, 1999, p. 119.
- [117] H. Kallath, F. K. Kholi, M. Y. Ha, J. K. Min, and J. Chetwynd-Chatwin, "Computational Study on the Aerodynamics of a Surface-Heated Wing for Thermal Management," *AIAA J.*, vol. 58, no. 10, pp. 4339–4356, 2020.
- [118] L. P. Pang, X. M. Dang, and J. Cheng, "Study on heat transfer performance of skin heat exchanger," *Exp. Heat Transf.*, vol. 28, no. 4, pp. 317–327, 2015, doi: 10.1080/08916152.2013.876461.
- [119] H. Kellermann, A. L. Habermann, and M. Hornung, "Assessment of aircraft surface heat exchanger potential," *Aerospace*, vol. 7, no. 1, 2019, doi: 10.3390/aerospace7010001.
- [120] B. L. Messinger, "Equilibrium temperature of an unheated icing surface as a function of air speed," *J. Aeronaut. Sci.*, vol. 20, no. 1, pp. 29–42, 1953.
- [121] M. D. Guenov, X. Chen, A. Molina-Cristóbal, A. Riaz, A. S. J. Van Heerden, and M. Padulo, "Margin allocation and tradeoff in complex systems design and optimization," *AIAA J.*, vol. 56, no. 7, 2018, doi: 10.2514/1.J056357.
- [122] Z. Goraj, "An overview of the deicing and anti-icing technologies with prospects for the future," in *24th international congress of the aeronautical sciences*, 2004, vol. 29.
- [123] Q. Su, S. Chang, Y. Zhao, H. Zheng, and C. Dang, "A review of loop heat pipes for aircraft anti-icing applications," *Appl. Therm. Eng.*, vol. 130, pp. 528–540, 2018.
- [124] A. L. F. Phillips and K. L. Wert, "Loop heat pipe anti icing system development program summary," SAE Technical Paper, 2000.
- [125] A. L. F. Phillips and N. J. Gernert, "Passive aircraft anti icing system using waste heat," SAE Technical Paper, 1998.
- [126] C. Buffone *et al.*, "Capillary pressure in graphene oxide nanoporous membranes for enhanced heat transport in Loop Heat Pipes for aeronautics," *Exp. Therm. Fluid Sci.*, vol. 78, pp. 147–152, 2016.
- [127] R. Langton, C. Clark, M. Hewitt, and L. Richards, *Aircraft fuel systems*, vol. 24. John Wiley & Sons, 2009.
- [128] A. B. Donovan, R. A. Roberts, and M. Wolff, "Fuel pump trade study for a conceptual design of an integrated air vehicle system," 2015, [Online]. Available: <https://www.scopus.com/inward/record.uri?eid=2-s2.0-84946085884&partnerID=40&md5=fdcca4855e47d2a5b84e69f12997dc24>.

- [129] S. M. Summer, *Fuel Tank Flammability Assessment Method User's Manual*. Office of Aviation Research and Development, Federal Aviation Administration, 2008.
- [130] R. W. Morris Jr., J. Miller, and S. Y. Limaye, "Fuel deoxygenation and aircraft thermal management," in *Collection of Technical Papers - 4th International Energy Conversion Engineering Conference*, 2006, vol. 1, pp. 285–297, [Online]. Available: <https://www.scopus.com/inward/record.uri?eid=2-s2.0-33751418099&partnerID=40&md5=436b30bcc3c9e83f5ab8aa2496fef3aa>.
- [131] Y.-H. B. Ho, T. Lin, B. P. Hill, and G. B. Tibbs, "Thermal benefits of advanced integrated fuel system using JP-8+100 fuel," 1997, doi: 10.2514/6.1997-5507.
- [132] A. J. Fischer, "Future fuel heat sink thermal management system technologies," in *Collection of Technical Papers - 4th International Energy Conversion Engineering Conference*, 2006, vol. 1, pp. 267–284, [Online]. Available: <https://www.scopus.com/inward/record.uri?eid=2-s2.0-33751429719&partnerID=40&md5=7664620e0def1a74f074dd36fab82125>.
- [133] D. B. Doman, "Optimal cruise altitude for thermal management," 2015.
- [134] S. Qian, C. S. Nan, and Y. S. Yu, "Analysis of aircraft integrated thermal management using fuel as heat sink," in *2016 IEEE International Conference on Aircraft Utility Systems (AUS)*, 2016, pp. 774–779, doi: 10.1109/AUS.2016.7748157.
- [135] E. J. Alyanak and D. L. Allison, "Fuel thermal management system considerations in the aircraft conceptual design process," 2016, [Online]. Available: <https://www.scopus.com/inward/record.uri?eid=2-s2.0-84958559218&partnerID=40&md5=afa206bbe067c7baa380b28e7e6c72cf>.
- [136] D. B. Doman, "Fuel flow control for extending aircraft thermal endurance part I: Underlying principles," in *AIAA Guidance, Navigation, and Control Conference*, 2016, p. 1621.
- [137] D. B. Doman, "Fuel flow control for extending aircraft thermal endurance part II: Closed loop control," in *AIAA Guidance, Navigation, and Control Conference*, 2016, p. 1622.
- [138] D. B. Doman, "Fuel flow topology and control for extending aircraft thermal endurance," *J. Thermophys. Heat Transf.*, vol. 32, no. 1, pp. 35–50, 2018.
- [139] D. Sigthorsson, M. W. Oppenheimer, and D. B. Doman, "Flight Endurance Enhancement Via Thermal Management System Control Subject To Multiple Limitations," in *AIAA Scitech 2020 Forum*, 2020, p. 1825.
- [140] D. Sigthorsson, M. W. Oppenheimer, D. B. Doman, G. P. Huang, and A. L. Tipton, "Flight Endurance Enhancing Thermal Management Part I: Online Saturated Flow Control Design," in *AIAA Scitech 2021 Forum*, 2021, p. 642.
- [141] D. Sigthorsson, M. W. Oppenheimer, D. B. Doman, G. P. Huang, and A. L. Tipton, "Flight Endurance Enhancing Thermal Management Part II: Thermal Endurance Gauge And Mission Planning," in *AIAA Scitech 2021 Forum*, 2021, p. 643.
- [142] G. P. Huang *et al.*, "Dimensional analysis, modeling, and experimental validation of an aircraft fuel thermal management system," *J. Thermophys. Heat Transf.*, vol. 33, no. 4, pp. 983–993, 2019, doi: 10.2514/1.T5660.
- [143] K. McCarthy and G. R. Jackson, "Risk Assessment of Fuel Property Variability Using Quasi-Random Sampling/Design of Experiments Methodologies," *SAE Tech. Pap.*, no. March, 2019, doi: 10.4271/2019-01-1387.
- [144] H. Kellermann, A. L. Habermann, P. C. Vratny, and M. Hornung, "Assessment of fuel as alternative heat sink for future aircraft," *Appl. Therm. Eng.*, vol. 170, p. 114985, 2020.

- [145] T. Guan, "Fuel System Water/Ice Management Using OBIGGS, MSc Thesis," Cranfield University, 2014.
- [146] Y. Terada, C. P. Lawson, and A. Z. Shahneh, "Analytical investigation into the effects of Nitrogen enriched air bubbles to improve aircraft fuel system water management," *Proc. Inst. Mech. Eng. Part G J. Aerosp. Eng.*, p. 0954410017742422, 2017.
- [147] Z. Kang, Z. LIU, G. REN, and Y. LV, *Fuel Tank Modeling and Fuel Temperature Simulation of an Aircraft in Steady-State and Transient-State Methods*. 2015.
- [148] K. McCarthy *et al.*, "Dynamic thermal management system modeling of a more electric aircraft," *SAE Tech. Pap.*, 2008, doi: 10.4271/2008-01-2886.
- [149] M. Wolff, "Aerothermal Design of an Engine/Vehicle Thermal Management System (NATO Report RTO-EN-AVT-195)," 2011. doi: 10.14339/RTO-EN-AVT-195.
- [150] P. Blázquez, "Fuel temperature estimation and energy balance within an UAV integral wing fuel tank," *Heat Transf. XIII Simul. Exp. Heat Mass Transf.*, vol. 83, p. 463, 2014.
- [151] C. Zilio, G. A. Longo, G. Pernigotto, F. Chiacchio, P. Borrelli, and E. D'Errico, "CFD analysis of aircraft fuel tanks thermal behaviour," in *Journal of Physics: Conference Series*, 2017, vol. 923, no. 1, p. 12027.
- [152] B. Grinstead and S. Zabarnick, "Studies of jet fuel thermal stability, oxidation, and additives using an isothermal oxidation apparatus equipped with an oxygen sensor," *Energy & fuels*, vol. 13, no. 3, pp. 756–760, 1999.
- [153] X. Pei, L. Hou, and Z. Ren, "Kinetic Modeling of Thermal Oxidation and Coking Deposition in Aviation Fuel," *Energy & Fuels*, vol. 31, no. 2, pp. 1399–1405, Feb. 2017, doi: 10.1021/acs.energyfuels.6b02869.
- [154] US Department of Transportation: Federal Aviation Administration, "Advisory Circular AC 25.981-1D: Fuel Tank Ignition Source Prevention Guidelines." 2018.
- [155] US Department of Transportation: Federal Aviation Administration, "Advisory Circular AC 25.981-1C: FUEL TANK IGNITION SOURCE PREVENTION GUIDELINES." 2008.
- [156] US Department of Transportation: Federal Aviation Administration, "Advisory Circular AC 25.981-2A: FUEL TANK FLAMMABILITY REDUCTION MEANS." 2008.
- [157] B. Song, X. Wang, and H. Zhang, "The aircraft composite integral fuel tank fire safety performance analysis and shrinkage ratio simulation calculation," *Procedia Eng.*, vol. 52, pp. 320–324, 2013.
- [158] R. Rolfes, J. Tessmer, and K. Rohwer, "Models and tools for heat transfer, thermal stresses, and stability of composite aerospace structures," *J. Therm. Stress.*, vol. 26, no. 6, pp. 641–670, 2003.
- [159] D. Petersen, R. Rolfes, and R. Zimmermann, "Thermo-mechanical design aspects for primary composite structures of large transport aircraft," *Aerosp. Sci. Technol.*, vol. 5, no. 2, pp. 135–146, 2001.
- [160] C. Lui, M. Dooley, and J. Duchene, "Power & Thermal Systems Integration Techniques for High Performance Jet Aircraft," *SAE Int. J. Aerosp.*, vol. 5, no. 2012-01–2164, pp. 337–343, 2012.
- [161] F. Jacob, A. M. Rolt, J. M. Sebastiampillai, V. Sethi, M. Belmonte, and P. Cobas, "Performance of a supercritical CO₂ bottoming cycle for aero applications," *Appl. Sci.*, vol. 7, no. 3, p. 255, 2017.

- [162] A. Sharma, V. V. Tyagi, C. R. Chen, and D. Buddhi, "Review on thermal energy storage with phase change materials and applications," *Renew. Sustain. Energy Rev.*, vol. 13, no. 2, pp. 318–345, Feb. 2009, doi: 10.1016/J.RSER.2007.10.005.
- [163] S. Gagne, R. J. Rodriguez, W. L. Siegel, and J. R. Arvin, "Phase change material cooling system for a vehicle." Google Patents, Jan. 03, 2017.
- [164] J. S. Breit, C. J. Roberts, A. Faghri, T. R. Ward, and C. Robak, "Utilizing phase change material, heat pipes, and fuel cells for aircraft applications." Google Patents, Jan. 17, 2017.
- [165] A. Elefsiniotis, T. Becker, and U. Schmid, "Thermoelectric energy harvesting using phase change materials (PCMs) in high temperature environments in aircraft," *J. Electron. Mater.*, vol. 43, no. 6, pp. 1809–1814, 2014, doi: 10.1007/s11664-013-2880-9.
- [166] A. Elefsiniotis, N. Kokorakis, T. Becker, and U. Schmid, "A Novel High-temperature Aircraft-specific Energy Harvester Using PCMs and State of the art TEGs," *Mater. Today Proc.*, vol. 2, no. 2, pp. 814–822, 2015, doi: <https://doi.org/10.1016/j.matpr.2015.05.105>.
- [167] S. Madruga, "Thermoelectric energy harvesting in aircraft with porous phase change materials," *IOP Conf. Ser. Earth Environ. Sci.*, vol. 354, p. 12123, 2019, doi: 10.1088/1755-1315/354/1/012123.
- [168] M. Shi, M. Sanders, A. Alahmad, C. Perullo, G. Cinar, and D. N. Mavris, "Design and Analysis of the Thermal Management System of a Hybrid Turboelectric Regional Jet for the NASA ULI Program," in *AIAA Propulsion and Energy 2020 Forum*, 2020, p. 3572.
- [169] D. B. Go, "Thermoelectric effect and thermoelectric devices (AME60634 intermediate heat transfer lecture notes - University of Notre Dame)." University of Notre Dame, Notre Dame, Indiana, 2014.
- [170] D. Champier, "Thermoelectric generators: A review of applications," *Energy Convers. Manag.*, vol. 140, pp. 167–181, 2017, doi: <https://doi.org/10.1016/j.enconman.2017.02.070>.
- [171] P. Ziolkowski, K. Zabrocki, and E. Müller, "TEG Design for Waste Heat Recovery at an Aviation Jet Engine Nozzle," *Applied Sciences*, vol. 8, no. 12. 2018, doi: 10.3390/app8122637.
- [172] X. Moya, S. Kar-Narayan, and N. D. Mathur, "Caloric materials near ferroic phase transitions," *Nat. Mater.*, vol. 13, p. 439, Apr. 2014, [Online]. Available: <https://doi.org/10.1038/nmat3951>.
- [173] S. Crossley, N. D. Mathur, and X. Moya, "New developments in caloric materials for cooling applications," *AIP Adv.*, vol. 5, no. 6, p. 67153, Jun. 2015, doi: 10.1063/1.4922871.
- [174] R. W. Dyson, L. Rodriguez, M. E. Roth, and P. Raitano, "Solid-State Exergy Optimized Electric Aircraft Thermal and Fault Management," in *2020 AIAA/IEEE Electric Aircraft Technologies Symposium (EATS)*, 2020, pp. 1–16.
- [175] M. Ryemill and J. K. Min, "The Rolls-Royce PLC ultrafan heat management challenge," 2016.
- [176] H. Strumpf and Z. Mirza, "Development of a Microchannel Heat Exchanger for Aerospace Applications," in *ASME 2012 10th International Conference on Nanochannels, Microchannels, and Minichannels*, Jul. 2012, pp. 459–467, doi: 10.1115/ICNMM2012-73043.
- [177] W. C. Reed, M. R. von Spakovsky, and P. Raj, "Comparison of heat exchanger and thermal energy storage designs for aircraft thermal management systems," 2016, [Online]. Available: <https://www.scopus.com/inward/record.uri?eid=2-s2.0-85007478150&partnerID=40&md5=279c4a448d310e0da6e41b7def05f7c2>.

- [178] W. C. Reed, "Comparison of Heat Exchanger Designs for Aircraft Thermal Management Systems," Virginia Tech, 2015.
- [179] R. Wrobel, B. Scholes, A. Hussein, R. Law, A. Mustaffar, and D. Reay, "A metal additively manufactured (MAM) heat exchanger for electric motor thermal control on a high-altitude solar aircraft—Experimental characterisation," *Therm. Sci. Eng. Prog.*, vol. 19, p. 100629, 2020.
- [180] H. Kellermann, M. Lüdemann, M. Pohl, and M. Hornung, "Design and Optimization of Ram Air-Based Thermal Management Systems for Hybrid-Electric Aircraft," *Aerospace*, vol. 8, no. 1, 2021, doi: 10.3390/aerospace8010003.
- [181] W. G. Anderson, J. Hartenstine, M. Ellis, J. Montgomery, and C. Peters, "Electronics cooling using high temperature loop heat pipes with multiple condensers," *SAE Tech. Pap.*, 2010, doi: 10.4271/2010-01-1736.
- [182] M. Donovan and P. Del Valle, "Aeronautical passive energy recovery system based on LHP technology extended test results," *SAE Tech. Pap.*, no. September, 2014, doi: 10.4271/2014-01-2191.
- [183] M. Mitomi and H. Nagano, "Long-distance loop heat pipe for effective utilization of energy," *Int. J. Heat Mass Transf.*, vol. 77, pp. 777–784, 2014.
- [184] A. J. Fleming, Q. H. Leland, K. L. Yerkes, L. J. Elston, and S. K. Thomas, "Aircraft thermal management using loop heat pipes: Experimental simulation of high acceleration environments using the centrifuge table test bed," *SAE Tech. Pap.*, 2006, doi: 10.4271/2006-01-3066.
- [185] C. Sarno, C. Tantolin, R. Hodot, Y. Maydanik, and S. Vershinin, "Loop thermosyphon thermal management of the avionics of an in-flight entertainment system," *Appl. Therm. Eng.*, vol. 51, no. 1–2, pp. 764–769, 2013, doi: 10.1016/j.applthermaleng.2012.10.012.
- [186] A. Faghri, "Review and Advances in Heat Pipe Science and Technology," *J. Heat Transfer*, vol. 134, no. 12, Oct. 2012, doi: 10.1115/1.4007407.
- [187] E. Anselmi, I. Bunce, and V. Pachidis, "An Overview of Initial Operational Experience With the Closed-Loop sCO₂ Test Facility at Cranfield University," in *Turbo Expo: Power for Land, Sea, and Air*, 2019, vol. 58721, p. V009T38A022.
- [188] E. Anselmi, I. Bunce, V. Pachidis, P. Zachos, and M. Johnston, "An overview of the Rolls-Royce sCO₂-test rig project at Cranfield University," 2018.
- [189] P. McCluskey, Y. Saadon, Z. Yao, J. Shah, and J. Kizito, "Thermal Management Challenges in Turbo-Electric and Hybrid Electric Propulsion," in *2018 International Energy Conversion Engineering Conference*, 2018, p. 4695.
- [190] D. Baird and J. Ferentinos, "Application of MIL-C-87252 in F-22 liquid cooling system," *SAE Tech. Pap.*, 1998, doi: 10.4271/981543.
- [191] O. Yetik and T. H. Karakoc, "Thermal management system with nanofluids for hybrid electric aircraft battery," *Int. J. Energy Res.*, 2021.
- [192] W. Wu, S. Wang, W. Wu, K. Chen, S. Hong, and Y. Lai, "A critical review of battery thermal performance and liquid based battery thermal management," *Energy Convers. Manag.*, vol. 182, pp. 262–281, 2019, doi: <https://doi.org/10.1016/j.enconman.2018.12.051>.
- [193] J. Homitz, R. Scaringe, and G. Cole, "Evaluation of a vapor-compression thermal management system for reliability while operating under thermal transients," *SAE Tech. Pap.*, 2010, doi: 10.4271/2010-01-1733.

- [194] L. Byrd, A. Cole, B. Cranston, S. Emo, J. Ervin, and T. E. Michalak, "Two phase thermal energy management system," *SAE Tech. Pap.*, 2011, doi: 10.4271/2011-01-2584.
- [195] S. Emo, J. Ervin, T. E. Michalak, and V. Tsao, "Cycle-based vapor cycle system control and active charge management for dynamic airborne applications," *SAE Tech. Pap.*, no. September, 2014, doi: 10.4271/2014-01-2224.
- [196] T. E. Michalak, S. Emo, and J. Ervin, "Control strategy for aircraft vapor compression system operation," *Int. J. Refrig.*, vol. 48, pp. 10–18, 2014, doi: 10.1016/j.ijrefrig.2014.08.010.
- [197] D. T. Pollock, M. A. Williams, and B. M. Hincey, "Model predictive control of temperature-sensitive and transient loads in aircraft vapor compression systems," in *Proceedings of the American Control Conference*, 2016, vol. 2016-July, pp. 575–580, doi: 10.1109/ACC.2016.7524975.
- [198] M. Zhao, L. Pang, M. Liu, S. Yu, and X. Mao, "Control Strategy for Helicopter Thermal Management System Based on Liquid Cooling and Vapor Compression Refrigeration," *Energies*, vol. 13, no. 9, p. 2177, 2020.
- [199] A. Bhatia, "Overview of vapor absorption cooling systems," *Lecture Notes. Stony Point: Continuing Education and Development*. 2011.
- [200] N. Payne, M. Wolff, R. Roberts, L. Elston, and J. McCoppin, "Experimental Validation of a Combined Thermal Management and Power Generation System using a Multi-Mode Rankine Cycle," in *AIAA Propulsion and Energy 2020 Forum*, 2020, p. 3951.
- [201] E. Fricke and A. P. Schulz, "Design for changeability (DfC): Principles to enable changes in systems throughout their entire lifecycle," *Syst. Eng.*, vol. 8, no. 4, pp. 342–359, 2005, [Online]. Available: <http://www.scopus.com/inward/record.url?eid=2-s2.0-30544446870&partnerID=40&md5=5c25be5cfd56e4cef05808c6c1a41bda>.
- [202] Aerospace Technology Institute, "ACCELERATING AMBITION: Technology Strategy 2019," 2019. [Online]. Available: <https://www.ati.org.uk/media/siybi1mm/ati-tech-strategy.pdf>.
- [203] B. J. Brelje and J. R. R. A. Martins, "Electric, hybrid, and turboelectric fixed-wing aircraft: A review of concepts, models, and design approaches," *Prog. Aerosp. Sci.*, vol. 104, pp. 1–19, 2019, doi: <https://doi.org/10.1016/j.paerosci.2018.06.004>.
- [204] National Academies of Sciences Engineering, Medicine, and National Academies of Sciences Engineering and Medicine, *Commercial aircraft propulsion and energy systems research: reducing global carbon emissions*. National Academies Press, 2016.
- [205] C. Perullo *et al.*, "Sizing and Performance Analysis of a Turbo-Hybrid-Electric Regional Jet for the NASA ULI Program," in *AIAA Propulsion and Energy 2019 Forum*, 2019, p. 4490.
- [206] J. L. Freeman and B. T. Schiltgen, "Eco-150-300 design and performance: A tube-and-wing distributed electric propulsion airliner," 2019, doi: 10.2514/6.2019-1808.
- [207] J. M. Rheume and C. E. Lents, "Design and Simulation of a Commercial Hybrid Electric Aircraft Thermal Management System," 2018, doi: 10.2514/6.2018-4994.
- [208] J. M. Rheume, C. E. Lents, and M. MacDonald, "Commercial hybrid electric aircraft thermal management system design, simulation, and operation improvements," 2019, doi: 10.2514/6.2019-4492.
- [209] J. M. Rheume and C. E. Lents, "Commercial Hybrid Electric Aircraft Thermal Management Sensitivity Studies," in *2020 AIAA/IEEE Electric Aircraft Technologies Symposium (EATS)*, 2020, pp. 1–6.

- [210] D. Trawick, C. Perullo, M. Armstrong, D. Snyder, J. C. M. Tai, and D. N. Mavris, "Development and application of GT-HEAT to design of the Electrically Variable Engine (EVE)," 2017, doi: 10.2514/6.2017-1922.
- [211] J. K. Lytle, "The numerical propulsion system simulation: an overview (NASA Report no: TM-2000-209915)." NASA, 2000.
- [212] C. Perullo *et al.*, "An Update on Sizing and Performance Analysis of a Hybrid Turboelectric Regional Jet for the NASA ULI Program," in *2020 AIAA/IEEE Electric Aircraft Technologies Symposium (EATS)*, 2020, pp. 1–17.
- [213] J. W. Chapman, H. Hasseeb, and S. Schnulo, "Thermal Management System Design for Electrified Aircraft Propulsion Concepts," in *2020 AIAA/IEEE Electric Aircraft Technologies Symposium (EATS)*, 2020, pp. 1–23.
- [214] S. Byahut and A. Uranga, "Power Distribution and Thermal Management Modeling for Electrified Aircraft," in *2020 AIAA/IEEE Electric Aircraft Technologies Symposium (EATS)*, 2020, pp. 1–15.
- [215] P. Abolmoali *et al.*, "Integrated Propulsive and Thermal Management System Design for Optimal Hybrid Electric Aircraft Performance," in *2020 AIAA/IEEE Electric Aircraft Technologies Symposium (EATS)*, 2020, pp. 1–17.
- [216] G.L. Thomas, J. W. Chapman, H. Hasseeb, J. Fuzaro Alencar, D. Sadey, and J. Csank, "Multidisciplinary Systems Analysis of a Six Passenger Quadrotor Urban Air Mobility Vehicle Powertrain," in *AIAA Propulsion and Energy 2020 Forum*, 2020, p. 3564.
- [217] H. Knight, "Rolls-Royce sets new record with UltraFan power gearbox," *The Engineer*, 2017. <https://www.theengineer.co.uk/rolls-royce-ultrafan-gearbox/> (accessed Dec. 12, 2020).
- [218] F. Haselbach, A. Newby, and R. Parker, "Concepts & technologies for the next generation of large civil aircraft engines," 2014.
- [219] V. Shanmugasundaram, M. L. Ramalingam, B. Donovan, T. Mahefkey, and B. Hager, "Aircraft power system options and thermal management for high, pulsed power application," in *American Society of Mechanical Engineers, Advanced Energy Systems Division (Publication) AES*, 2004, vol. 44, pp. 75–82, doi: 10.1115/IMECE2004-62554.
- [220] V. Shanmugasundaram, M. L. Ramalingam, B. Donovan, T. Mahefkey, and B. Hager, "Analytical investigation of thermal management options for an aircraft based high pulsed power system application," in *Collection of Technical Papers - 3rd International Energy Conversion Engineering Conference*, 2005, vol. 2, pp. 1213–1226, [Online]. Available: <https://www.scopus.com/inward/record.uri?eid=2-s2.0-29144504322&partnerID=40&md5=3374ac499592bbd4b7cf3e2fb214cdce>.
- [221] V. Shanmugasundaram, M. L. Ramalingam, B. Donovan, and T. Mahefkey, "Aircraft based pulsed power system thermal management options with energy storage," in *Collection of Technical Papers - 4th International Energy Conversion Engineering Conference*, 2006, vol. 1, pp. 252–266, [Online]. Available: <https://www.scopus.com/inward/record.uri?eid=2-s2.0-33751419272&partnerID=40&md5=677a4fd1cf2dc1e742038eee653240d9>.
- [222] V. Shanmugasundaram, M. L. Ramalingam, B. D. Donovan, J. P. Fellner, and C. Miller, "Evaluation of a thermal management system with energy storage for an airborne laser power system," 2006, doi: 10.1115/IMECE2006-13372.
- [223] V. Shanmugasundaram, M. L. Ramalingam, and B. Donovan, "Thermal management system with energy storage for an airborne laser power system application," in *5th International Energy Conversion Engineering Conference and Exhibit (IECEC)*, 2007, p. 4817.

- [224] J. P. Fellner, R. M. Miller, and V. Shanmugasundaram, "Rechargeable lithium-ion based batteries and thermal management for airborne high energy electric lasers," *SAE Tech. Pap.*, 2006, doi: 10.4271/2006-01-3083.
- [225] A. Donovan, S. Nuzum, R. A. Roberts, and M. Wolff, "Impact of high energy pulsed systems on an aircraft's power and thermal management system," 2016, [Online]. Available: <https://www.scopus.com/inward/record.uri?eid=2-s2.0-84958554554&partnerID=40&md5=909b34c59ecacd70e578d85ff313cc06>.
- [226] S. R. Nuzum, A. Donovan, R. A. Roberts, and M. Wolff, "Dynamic modeling at a vehicle level of a cryogenic based thermal system for a high powered system," 2016, [Online]. Available: <https://www.scopus.com/inward/record.uri?eid=2-s2.0-84958568501&partnerID=40&md5=4aa2f818c2e1c3428a993de9ddeb907>.
- [227] M. Merzvinckas, C. Bringhamti, J. T. Tomita, and C. R. de Andrade, "Air conditioning systems for aeronautical applications: a review," *Aeronaut. J.*, vol. 124, no. 1274, pp. 499–532, 2020.
- [228] M. Shi, I. Chakraborty, Y. Cai, J. C. Tai, and D. N. Mavris, "Mission-Level Study of Integrated Gas Turbine and Environmental Control System Architectures," in *2018 AIAA Aerospace Sciences Meeting*, 2018, p. 1751.
- [229] J. Herzog, "Electrification of the environmental control system," in *25th International congress of the aeronautical sciences*, 2006, pp. 1–4.
- [230] J. A. Parrilla, "Hybrid environmental control system integrated modeling trade study analysis for commercial aviation," *SAE Tech. Pap.*, no. September, 2014, doi: 10.4271/2014-01-2155.
- [231] M. Sielemann, T. Giese, B. Oehler, and M. Gräber, "Optimization of an unconventional environmental control system architecture," *SAE Int. J. Aerosp.*, vol. 4, no. 2011-01–2691, pp. 1263–1275, 2011.
- [232] H. Kang, J. Heo, and Y. Kim, "Performance characteristics of a vapor compression cooling cycle adopting a closed-loop air-circulation system for avionic reconnaissance equipment," *Int. J. Refrig.*, vol. 35, no. 4, pp. 785–794, 2012.
- [233] D. C. Price, "Thermal management of military fighter aircraft electro-optics pod: An invited paper," in *Annual IEEE Semiconductor Thermal Measurement and Management Symposium*, 2003, pp. 341–350, [Online]. Available: <https://www.scopus.com/inward/record.uri?eid=2-s2.0-0037272196&partnerID=40&md5=ec97bb14e55f233eaea6ceb8c4e0c3f3>.
- [234] A. Jones, T. Childs, R. Chen, and A. Murray, "Thermal sensitivity analysis of avionic and environmental control subsystems to variations in flight condition," 2016, [Online]. Available: <https://www.scopus.com/inward/record.uri?eid=2-s2.0-85007489610&partnerID=40&md5=eb24db1f63f60cb6c8bb7a4d268809be>.
- [235] Y. Tu and G. P. Lin, "Dynamic simulation of aircraft environmental control system based on flowmaster," *J. Aircr.*, vol. 48, no. 6, pp. 2031–2041, 2011.
- [236] I. Jennions, F. Ali, M. E. Miguez, and I. C. Escobar, "Simulation of an aircraft environmental control system," *Appl. Therm. Eng.*, vol. 172, p. 114925, 2020.
- [237] B. S. Aranjo, B. R. Hughes, and H. N. Chaudry, "Performance investigation of ground cooling for the Airbus A380 in the United Arab Emirates," *Appl. Therm. Eng.*, vol. 36, pp. 87–95, 2012.
- [238] J. Maier, C. Marggraf-Micheel, T. Dehne, and J. Bosbach, "Thermal comfort of different displacement ventilation systems in an aircraft passenger cabin," *Build. Environ.*, vol. 111, pp. 256–264, 2017.

- [239] S. Park, R. T. Hellwig, G. Grün, and A. Holm, "Local and overall thermal comfort in an aircraft cabin and their interrelations," *Build. Environ.*, vol. 46, no. 5, pp. 1056–1064, 2011.
- [240] J. Bosbach and T. Dehne, "Propagation of localized, unsteady heat loads in aircraft cabin air flows," *CEAS Aeronaut. J.*, vol. 7, no. 1, pp. 57–68, 2016.
- [241] H. Yang and C. Yang, "Derivation and comparison of thermodynamic characteristics of endoreversible aircraft environmental control systems," *Appl. Therm. Eng.*, vol. 180, p. 115811, 2020.
- [242] H. Yang and C. Yang, "Thermodynamic Characteristics and Order Degree of Air Cycle System," *Int. J. Refrig.*, 2020.
- [243] H. Yang and C. Yang, "Application of scaling-endoreversible thermodynamic analysis model to aircraft environmental control system-methodology development," *Int. J. Refrig.*, vol. 112, pp. 90–99, 2020.
- [244] D. Zimmer, "Robust object-oriented formulation of directed thermofluid stream networks," *Math. Comput. Model. Dyn. Syst.*, vol. 26, no. 3, pp. 204–233, 2020.
- [245] J. Sprouse, "F-22 environmental control/thermal management fluid transport optimization," *SAE Tech. Pap.*, 2000, doi: 10.4271/2000-01-2266.
- [246] R. Ashford and S. Brown, "F-22 environmental control system/thermal management system (ECS/TMS) flight test program - Downloadable constants, an innovative approach," *SAE Tech. Pap.*, 2000, doi: 10.4271/2000-01-2265.
- [247] S. Y. Yu and E. Ganev, "Next generation power and thermal management system," *SAE Tech. Pap.*, vol. 1, no. 1, pp. 1107–1121, 2008, doi: 10.4271/2008-01-2934.
- [248] E. Ganev and M. Koerner, "Power and thermal management for future aircraft," *SAE Tech. Pap.*, vol. 7, 2013, doi: 10.4271/2013-01-2273.
- [249] M. Bodie, "Power thermal management system design for enhanced performance in an aircraft vehicle," *SAE Tech. Pap.*, 2010, doi: 10.4271/2010-01-1805.
- [250] M. Bodie, G. Russell, K. McCarthy, E. Lucus, J. Zumberge, and M. Wolff, "Thermal analysis of an integrated aircraft model," 2010, [Online]. Available: <https://www.scopus.com/inward/record.uri?eid=2-s2.0-78649808211&partnerID=40&md5=85198228a3c12cbe2797410887ce2843>.
- [251] T. C. O'Connell, C. Lui, P. Walia, and J. Tschantz, "A hybrid economy bleed, electric drive adaptive power and thermal management system for more electric aircraft," *SAE Tech. Pap.*, vol. 3, no. 1, pp. 168–172, 2010, doi: 10.4271/2010-01-1786.
- [252] T. T. Takahashi and S. Donovan, "Incorporation of mission payload power and thermal requirements into the multi-disciplinary aircraft performance and sizing process," 2010, doi: 10.2514/6.2010-9169.
- [253] C. Lui and M. Dooley, "Electric thermal management architectures," *SAE Tech. Pap.*, vol. 7, 2013, doi: 10.4271/2013-01-.
- [254] M. Dooley, C. Lui, and R. Newman, "Efficient propulsion, power, and thermal management integration," in *49th AIAA/ASME/SAE/ASEE Joint Propulsion Conference*, 2013, vol. 1 PartF, doi: 10.2514/6.2013-3681.
- [255] R. A. Roberts and D. D. Decker, "Control architecture study focused on energy savings of an aircraft thermal management system," in *Proceedings of the ASME Turbo Expo*, 2013, vol. 4, doi: 10.1115/GT2013-95922.

- [256] R. A. Roberts and S. M. Eastbourn, "Vehicle level tip-to-tail modeling of an aircraft," *Int. J. Thermodyn.*, vol. 17, no. 2, pp. 107–115, 2014, doi: 10.5541/ijot.523.
- [257] R. A. Roberts, M. Wolff, S. Nuzum, and A. Donovan, "Assessment of the vehicle level impact for a SOFC integrated with the power and thermal management system of an air vehicle," in *ASME 2015 Dynamic Systems and Control Conference, DSCC 2015*, 2015, vol. 1, doi: 10.1115/DSCC2015-9853.
- [258] P. Abolmoali, J. A. Parrilla, and A. Hamed, "Integrated aircraft thermal management & power generation: Reconfiguration of a closed loop air cycle system as a Brayton cycle gas generator to support auxiliary electric power generation," *SAE Tech. Pap.*, no. September, 2014, doi: 10.4271/2014-01-2192.
- [259] J. H. Kim, K. S. Kwon, S. Roy, E. Garcia, and D. Mavris, "Megawatt-class turboelectric distributed propulsion, power, and thermal systems for aircraft," in *AIAA Aerospace Sciences Meeting, 2018*, 2018, no. 210059, doi: 10.2514/6.2018-2024.
- [260] J. P. Koeln, H. C. Pangborn, M. A. Williams, M. L. Kawamura, and A. G. Alleyne, "Hierarchical control of aircraft electro-thermal systems," *IEEE Trans. Control Syst. Technol.*, 2019.
- [261] F. Torres and K. McCarthy, "Lockheed Martin Overview of the AFRL EXPEDITE Program: Power and Thermal Management System," in *AIAA Scitech 2020 Forum*, 2020, p. 1129.
- [262] Y. Sun and H. Smith, "Review and prospect of supersonic business jet design," *Prog. Aerosp. Sci.*, vol. 90, pp. 12–38, 2017, doi: <https://doi.org/10.1016/j.paerosci.2016.12.003>.
- [263] R. Hutchinson, J. Lawrence, and K. F. Joiner, "Conceptual design and integration of a propulsion system for a supersonic transport aircraft," *Proc. Inst. Mech. Eng. Part G J. Aerosp. Eng.*, p. 09544100211016952, May 2021, doi: 10.1177/09544100211016952.
- [264] E. Baltman, J. C. Tai, M. Shi, and D. N. Mavris, "An Investigation of Cooled Cooling Air for a Mach 2.2 Commercial Supersonic Transport," in *AIAA Propulsion and Energy 2021 Forum*, 2021, p. 3492.
- [265] D. Leney and D. Macdonald, *Aérospatiale/BAC Concorde, 1969 Onwards (all Models): Owners' Workshop Manual: an Insight Into Owning, Flying and Maintaining the World's First Supersonic Passenger Jet*. Haynes, 2010.
- [266] A. J. Fischer, "Design of a fuel thermal management system for long range air vehicles," in *Collection of Technical Papers - 3rd International Energy Conversion Engineering Conference*, 2005, vol. 2, pp. 1187–1204, [Online]. Available: <https://www.scopus.com/inward/record.uri?eid=2-s2.0-29144484135&partnerID=40&md5=58c41c2e4f253d22b417a55255b90d23>.
- [267] D. Schlabe and J. Lienig, "Model-based thermal management functions for aircraft systems," *SAE Tech. Pap.*, no. September, 2014, doi: 10.4271/2014-01-2203.
- [268] T. Brinson, J. A. Parrilla, and J. M. Molinar-Monterrubbio, "PREOVIDE as an approach to integrated modeling and simulation," *SAE Tech. Pap.*, no. September, 2014, doi: 10.4271/2014-01-2179.
- [269] N. Jain and B. M. Hency, "Increasing fuel thermal management system capability via objective function design," in *Proceedings of the American Control Conference*, 2016, vol. 2016-July, pp. 549–556, doi: 10.1109/ACC.2016.7524971.
- [270] R. A. Roberts, S. M. Eastbourn, and A. C. Maser, "Generic aircraft thermal tip-to-tail modeling and simulation," 2011, [Online]. Available: <https://www.scopus.com/inward/record.uri?eid=2-s2.0->

84880686444&partnerID=40&md5=8430dcc0d86e575842701b04a8abec93.

- [271] I. Roumeliotis *et al.*, "Integrated Systems Simulation for Assessing Fuel Thermal Management Capabilities for Hybrid-Electric Rotorcraft," Sep. 2020, doi: 10.1115/GT2020-15107.
- [272] D. R. Herber, J. T. Allison, R. Buettner, P. Abolmoali, and S. S. Patnaik, "Architecture Generation and Performance Evaluation of Aircraft Thermal Management Systems Through Graph-based Techniques," in *AIAA Scitech 2020 Forum*, 2020, p. 159.
- [273] B. J. German, M. J. Daskilewicz, and J. H. Doty, "Using interactive visualizations to assess aircraft thermal management system modeling approaches," 2011, doi: 10.2514/6.2011-7060.
- [274] B. C. Raczkowski *et al.*, "A MATLAB Simulink Based Co-Simulation Approach for a Vehicle Systems Model Integration Architecture," SAE Technical Paper, 2020.
- [275] M. Shi, J. Gladin, and D. N. Mavris, "A Systematic Methodology for Populating the Aircraft Thermal Management System Architecture Space," in *AIAA Scitech 2021 Forum*, American Institute of Aeronautics and Astronautics, 2021.
- [276] A. C. Maser, E. Garcia, and D. N. Mavris, "Thermal management modeling for integrated power systems in a transient, multidisciplinary environment," 2009, [Online]. Available: <https://www.scopus.com/inward/record.uri?eid=2-s2.0-77957833426&partnerID=40&md5=328d95b4566970e420554de95c7105cc>.
- [277] A. J. Heltzel, K. McCarthy, and S. Patnaik, "Rapid access to high-resolution thermal/fluid component modeling," *SAE Tech. Pap.*, vol. 10, 2012, doi: 10.4271/2012-01-2170.
- [278] C. J. Miller, A. C. Maser, E. Garcia, and D. N. Mavris, "INVENT surrogate modeling and optimization of transient thermal responses," 2012, doi: 10.2514/6.2012-1123.
- [279] A. T. Van Zwieten, G. Cinar, E. Garcia, J. C. Gladin, and D. N. Mavris, "Transient Surrogate Modeling for Thermal Management Systems," in *AIAA Scitech 2020 Forum*, 2020, p. 1616.
- [280] T. O. Deppen, J. E. Hey, A. G. Alleyne, and T. S. Fisher, "A model predictive framework for thermal management of aircraft," in *ASME 2015 Dynamic Systems and Control Conference, DSCC 2015*, 2015, vol. 1, doi: 10.1115/DSCC2015-9771.
- [281] M. E. Bell and J. S. Litt, "An Electrical Modeling and Thermal Analysis Toolbox for Electrified Aircraft Propulsion Simulation," in *AIAA Propulsion and Energy 2020 Forum*, 2020, p. 3676.
- [282] J. C. Gladin, D. Trawick, C. Perullo, J. C. Tai, and D. N. Mavris, "Modeling and design of a partially electric distributed aircraft propulsion system with GT-HEAT," in *55th AIAA Aerospace Sciences Meeting*, 2017, p. 1924.
- [283] G. la Rocca, "Knowledge based engineering: Between AI and CAD. Review of a language based technology to support engineering design," *Adv. Eng. informatics*, vol. 26, no. 2, pp. 159–179, 2012.
- [284] G. la Rocca, "Knowledge based engineering techniques to support aircraft design and optimization (PHD Thesis)," Delft University of Technology, 2011.
- [285] H. M. Reeve and A. M. Finney, "Probabilistic analysis for aircraft thermal management system design and evaluation," 2008, [Online]. Available: <https://www.scopus.com/inward/record.uri?eid=2-s2.0-78149421952&partnerID=40&md5=366739833a40207d0211ef8b5c61b1e8>.
- [286] D. Bodden, B. Eller, and S. Clements, "Integrated electrical and thermal management sub-

- system optimization," *SAE Tech. Pap.*, 2010, doi: 10.4271/2010-01-1812.
- [287] K. McCarthy *et al.*, "A real-time fuel thermal capacity and prognostics algorithm," *SAE Tech. Pap.*, vol. 10, 2012, doi: 10.4271/2012-01-2173.
- [288] P. Del Valle and P. Blazquez Munoz, "Advantages of the dynamic simulation for the thermal management systems design," *SAE Tech. Pap.*, no. September, 2014, doi: 10.4271/2014-01-2152.
- [289] C. A. Perullo, J. Tai, and D. N. Mavris, "A new sizing and synthesis environment for the design and assessment of advanced hybrid and electric aircraft propulsion systems," 2015.
- [290] R. Yeu *et al.*, "Introduction to Control Volume Based Transient Thermal Limit," SAE Technical Paper, 2020.
- [291] D. J. Harper, "Effectiveness-Based Design as an Important Part of the Conceptual Digital Twin: Observations from AFRL's EXPEDITE Program," in *AIAA Scitech 2021 Forum*, American Institute of Aeronautics and Astronautics, 2021.
- [292] P. C. Abolmoali, S. Patnaik, T. Deppen, and M. Boyd, "Sensitivity Analysis for the Design of Aircraft Thermal Management and Power Systems," in *AIAA Scitech 2021 Forum*, American Institute of Aeronautics and Astronautics, 2021.

Aircraft thermal management: Practices, technology, system architectures, future challenges, and opportunities

van Heerden, Albert S. J.

2021-11-12

Attribution-NonCommercial-NoDerivatives 4.0 International

van Heerden ASJ, Judt DM, Jafari S, et al., (2022) Aircraft thermal management: Practices, technology, system architectures, future challenges, and opportunities. *Progress in Aerospace Sciences*, Volume 128, January 2022, Article number 100767

<https://doi.org/10.1016/j.paerosci.2021.100767>

Downloaded from CERES Research Repository, Cranfield University