

CIT/CON/AERO-10

R 43935/A

CRANFIELD REPORT AERO. No. 10
MAY, 1972

CRANFIELD
INSTITUTE OF TECHNOLOGY

AIRCRAFT DESIGN STUDIES — VERTICAL TAKE OFF
AND LANDING AIRLINER

by

D. HOWE

R 43935/A



Cranfield Report Aero.No.10

May 1972

CRANFIELD INSTITUTE OF TECHNOLOGY

AIRCRAFT DESIGN STUDIES - VERTICAL TAKE OFF
AND LANDING AIRLINER

by

D. Howe

SUMMARY

During the 1970 academic year the students in Aircraft Design worked on the design of a vertical take off and landing airliner. The aircraft is intended to be capable of carrying up to 118 passengers over stage lengths of 500 n.miles. The maximum cruise speed is Mach 0.83 at an altitude of approximately 20,000 ft and the predicted take off weight is 125,000 lbs. Vertical take off is achieved by using 12 fan lift engines, each of 14500 lb thrust, which are based on the Rolls Royce RB 202 design. The lift engines are housed in two large nacelles which are mounted on the high, sweptback wing. The installed thrust/weight ratio of 1.4 makes allowance for hot and high operation, control requirements, and lift engine failure. An unusual feature of the design is the location of the two propulsion engines on either of the vertical fins.

Some indication was gained of the penalties associated with this type of aircraft, but the weighing of these against the realisable advantages was outside the scope of the work.

CONTENTS

	<u>Page</u>
1. INTRODUCTION	1
2. CONFIGURATION OF THE AIRCRAFT	2
3. CONTROL	4
4. PERFORMANCE	4
4.1 Take off and transition	4
4.2 Cruise	5
4.3 Descent and landing	5
5. DESIGN CONDITIONS	6
6. STRUCTURAL DESIGN	6
6.1 Fuselage	7
6.2 Wing	9
6.3 Lift engine nacelle	12
6.4 Tailplane	13
6.5 Fin	14
6.6 Undercarriage	16
7. POWERPLANT INSTALLATIONS	17
7.1 Propulsion engines	17
7.2 Lift engines	18
7.3 Auxiliary power unit	18
8. SYSTEMS	19
8.1 Flying controls	19
8.2 Fuel	20
8.3 Air conditioning	20
8.4 De-icing	21
9. DISCUSSION AND CONCLUSIONS	21
9.1 Unusual design features	21
9.2 Vertical take off penalty	23
9.3 Conclusions	23
REFERENCES	24
TABLE 1 Component weights	25
TABLE 2 Moments of inertia	27
TABLE 3 Aerofoil section coordinates	28
APPENDIX A Allocation of components	29
APPENDIX B Specification of aircraft	30

FIGURES

- 1 General arrangement of aircraft
- 2 Fuselage layout
- 3 Level flight speeds
- 4 Payload-range diagram
- 5 Lift curve slopes
- 6 Roll derivatives
- 7 Downwash at tail
- 8 Key structural drawing
- 9 Flap details
- 10 Lift engine nacelle
- 11 Main undercarriage
- 12 Nose undercarriage
- 13 Front propulsion engine mounting
- 14 Flying control system
- 15 Fuel system
- 16 Air conditioning system.

1. INTRODUCTION

As long ago as 1961 a large vertical take off freighter was (Ref.1) subject for the project design study undertaken by the students of Aircraft Design at Cranfield. This design had a gross weight of 250,000 lbs and was powered by no less than 44 low bypass ratio fan lift engines. These were installed in two wing mounted nacelles. A number of important conclusions were reached as the result of this design investigation. Apart from the obvious noise and operational difficulties associated with the use of such a large number of engines the nacelles were found to introduce serious wing fatigue and flutter difficulties. These were recognised as being due to the particular location chosen for the lift engine nacelles which was well out along the span of the wing.

During the intervening years there have been substantial developments in the design of fan lift engines and a much better understanding of the problems of aircraft lay-out associated with their use. The design of a technically and economically practical vertical take off transport using fan lift has become much more feasible. At the same time there has been a rapidly increasing problem of airport congestion in certain areas of the world. It has been suggested that the vertical take off airliner could mitigate this congestion problem by providing an additional traffic network operating from sites located nearer to centres of population than is possible with conventional airports. Hawker-Siddeley have undertaken extensive investigations in this field and developed several aircraft designs (Ref.2).

The 1970 project study was chosen in order to obtain a better understanding of the design features of fan lift vertical take off airliners. Known as the A70 the aircraft is intended to be able to carry up to 118 passengers over short stage lengths. Appendix A lists the students who were concerned in the investigation and gives their individual component responsibilities.

2. CONFIGURATION OF THE AIRCRAFT

The chosen configuration of the A70 design is shown in the general arrangement drawing, Figure 1. A detailed specification of the geometry, inertia and aerodynamic characteristics is given in Appendix B, Tables 1 to 3.

Some of the layout features of the A70 are unusual. One of the reasons for this is that in the initial phase of the study the possibility of water based operations was considered and the configuration was considerably influenced by this although in the event only a land based design was investigated.

The normal take off weight of the aircraft is 125,000 lbs, and the design landing weight 120,000 lbs. Twelve fan lift engines and two separate propulsion engines are used. The lift engines are derivatives of the Rolls Royce RB 202 type and each has a nominal static thrust of 14500 lb giving a total vertical thrust of 174,000 lbs. The implied nominal static thrust/weight ratio of 1.4 includes allowances for engine failure, adverse atmospheric conditions and control. The lift engines are housed in two wing nacelles which are located relatively near to the root of the high wing. The two propulsion engines are mounted on either side of the vertical fin. They have a bypass ratio of five and both performance and installation were based on a half thrust scale Rolls Royce RB 211 engine. During transition from vertical to forward flight the thrust of the propulsion engines is augmented by fore and aft tilting of the lift engines.

The wing geometry was chosen to enable the cruise to take place at Mach number of up to about 0.8. A high mounting is used for several reasons:-

- a) The lift engines are well clear of the ground thereby minimising the problems of ground interference and erosion.
- b) No special consideration was given to conventional take off and landing and hence the usual tail clearance problem at incidence near the ground is not present. Thus the high wing could be associated with a

relatively low mounted tailplane which was considered to be desirable to give satisfactory dynamic stall characteristics. At the same time the tailplane acts as a partial noise shield between the propulsion engines and the ground below the aircraft during normal climb out from transition.

- c) The high wing low tail layout lends itself most readily to water based considerations and associated necessity for high mounted propulsion engines.

The use of the high wing does result in the need to locate the lift engines in nacelles away from the fuselage side to reduce exhaust acoustic fatigue difficulties. A further penalty is the small sponsons required to mount the undercarriage off the sides of the fuselage. The wheels retract by rotating through 90° to lie below the cabin floor as can be seen in Figure 2. The take off wing loading of 125 lb/sq ft was determined primarily as a compromise between the conflicting requirements of cruise and transition. Double slotted trailing edge flaps are employed over part of the span to enable the actual transition wing lift coefficient to be set at 1.2, relative to a maximum predicted value of 1.65 in the appropriate configuration. Spoiler/speed brake units are located along the upper surface of the wing, just ahead of the flaps. These are intended for use both at high and transition speeds.

The internal layout of the fuselage is shown in Figure 2. The diameter of the circular cross section was determined by the need to provide adequate headroom below the wing at the same time as giving a sufficient floor width for six abreast tourist seating. The use of a double aisle was found to give an unacceptably large diameter and so a single one is used. With a seat pitch set at 33 inches it is possible to accommodate 118 passengers. Access to the cabin is by forward side doors and a rear ventral door. The latter is located below the tailplane and rear mounted auxiliary power unit and is outside the pressure area. Emergency escape exits are positioned above the undercarriage sponsons.

3. CONTROL

Conventional ailerons, rudder and elevator are used for controlling the aircraft at speeds above transition. Provision is made for trim adjustment of tailplane incidence.

During vertical and transition flight control and stabilisation are provided directly by the lift engines. These are arranged as four units of three engines each, port and starboard, and fore and aft. Differential throttling port to starboard and fore and aft is used for roll and pitch control respectively. Yaw control is obtained by differentially tilting the engines port to starboard. The nominal thrust/weight ratio includes an allowance of approximately 0.2 for these control functions.

4. PERFORMANCE

4.1 Take off and transition

The thrust/weight ratio was selected to enable the aircraft to operate safely at the nominal gross weight from aerodromes up to 5000 ft above sea level and at temperatures of up to ISA + 15°C. More severe conditions necessitate a reduction in take off weight.

A suggested take off procedure is as follows:-

- a) Take off vertically and then climb to 2000 ft at about 15° to the vertical. During this initial flight the climb could be backwards using lift engine tilt for thrust. This would enable a forward descent on to the pad to be made in the event of an emergency. However from a performance aspect it is desirable to gain forward speed in a conventional climb and turn back to the pad if necessary in an emergency.
- b) At 2000 ft altitude accelerate in level flight towards the transition condition. During transition the trailing edge flaps are deployed to the intermediate, high lift setting and aircraft incidence increased to give a lift coefficient of 1.2. As forward speed increases the lift engines are tilted to both reduce overall lift to the required magnitude and provide a forward thrust component to assist in overcoming intake momentum drag. Subsequently the lift engines are

throttled down and the transition is complete at 190 knots true air speed. This gives a speed margin of 1.2 over the stall speed in the transition configuration.

- c) The aircraft then climbs away, retracting the flaps, in a conventional manner.

Conventional take off is possible, but the comparatively high wing loading and limited rotation clearance imply the use of a relatively long runway for this type of aircraft.

4.2 Cruise

The predicted level flight speeds for the aircraft are shown in Figure 3 for the case of maximum continuous engine rating.

The normal cruise condition is $M = 0.78$ at 20,000 ft altitude, the payload-range characteristics for this being given in Figure 4. When a payload of 24,000 lbs is carried the basic still air range with reserve allowance is 550 n.miles. The assumed reserve allowance is sufficient for a baulked approach to just above ground level followed by a climb out, 100 n.mile diversion and final vertical landing.

4.3 Descent and landing

The transition to vertical flight at the end of the cruise is carried out at a similar altitude and speed as that following the initial climb. The design landing weight of 120,000 lbs was deliberately chosen to be sufficiently close to the take off weight to enable a safe landing to be made very soon after take off.

Transition in this case is initiated by deploying the trailing edge flaps to the high drag position. This gives an adequate speed margin over the stall to start the lift engines at 190 knots true air speed. Initially the lift engines are inclined to give a forward thrust component but the tilt is adjusted to give first vertical and then an aft thrust component as the nose of the aircraft is dropped to reduce aerodynamic lift. The spoiler/speed brakes are available to assist in maintaining both vertical and fore and aft trim.

A typical descent from transition would occur at 15° to the vertical with the final few feet vertical, once the aircraft has been centred over the landing area.

5. DESIGN CONDITIONS

The aircraft was designed to the requirements specified by BCAR in as far as they apply to vertical take off aircraft.

At low altitude the attainable cruising speed is relatively high and this has resulted in the use of high values of the design cruising speed, V_C , and the corresponding design diving speed V_D . As is shown in Figure 3, V_C is 400 knots equivalent airspeed but is limited to $M = 0.83$ above 16,500 ft. The assumed value for V_D of 500 knots equivalent airspeed or $M = 0.94$ is considered to be unduly severe. A figure of $M = 0.9$ above 16,500 ft is thought to be more reasonable.

The airframe was designed to have a life of 40,000 hours. The fatigue analysis of the wing undertaken by Simpson, (see Appendix A), included an assessment of average flight duration from which it was concluded that it would typically be 50 minutes.

The fuselage design differential pressure of 8 lb/sq in is sufficient to ensure that cabin altitude need never exceed 8000 ft.

The design vertical landing velocity was taken to be 12 ft/sec.

6. STRUCTURAL DESIGN

The structure of the aircraft is conventional in most respects. Various specifications of light alloy are extensively used. The fuselage is largely built up from sheet materials and the wing and fin employ integral machining from thick plates. Steel components are largely confined to the undercarriage, engine mountings and flap tracks. Figure 8 is a key diagram for the structure and indicates the location of the main components.

6.1 Fuselage

Although the fuselage is designed by a complex combination of loading cases the most significant for much of the shell is the pitch up case to 2.5g at V_D and design weight. Pressure considerations dominate over the front fuselage skinning.

The fuselage shell is constructed by redusing drawn L72 zed stringers onto the L72 skin plating. In the region of the wing attachments the skin thickness has the maximum value of 0.08 ins, whilst elsewhere it falls to a minimum of 0.05 ins. The 1.1 in deep stringers have a free flange width and thickness which vary between 0.3 to 0.6 ins and 0.036 to 0.064 ins respectively. There is a considerable variation in pitch with a minimum spacing of 3.15 in over the lower centre fuselage and a maximum of 11.0 ins over the forward upper fuselage. A typical value is 4 to 5 ins. Frame spacing is a nominal 20 ins along the cabin falling to approximately 14 ins in the tail cone. The basic frames are built up 0.05 in thick L72 plate web with extruded angle section L65 booms. The booms are located within the stringer line and cleated to them. Elliptically shaped windows having a depth of 14 ins and width of 10 ins are positioned between each pair of frames. A continuous 0.05 in thick light alloy reinforcing band is redused to the skin in the window region. The windows themselves have two separate 0.15 in thick glasses with a 0.4 in spacing between them.

Both the longitudinal and lateral floor beams are constructed from 0.05 in L72 plate with extruded angle L65 edge members and tee section seat rails. Identical light alloy forged fittings are used to connect the lateral beams to the frames. The loss of structural cross section in the main undercarriage bay area is made up by an extruded light

alloy keel member. This is in the shape of an inverted tee with four additional short stabilising legs and is some 20 ins wide and 5 ins deep.

The wing structure passes across the top of the fuselage and bolted shear attachments are made at each of the four spars, stations 506, 561, 604 and 666. The frames here are machined I section light alloy from billets in DTD 5090. A similar section and material is used for the two frame extension beams which support the main undercarriage trunnions. In the wing cutout region the fuselage longitudinal load carrying material is concentrated into three light alloy members. Two of these pass along the edges of the wing cutout and the third passes through the wing box on the centreline. The latter is essentially a box section, 5.2 ins square, built up from two 0.5 ins thick channel section extrusions. There is a separate pressure carrying ceiling below the wing box structure which consists of a 0.104 ins thick L72 plate stiffened by fore and aft channel section stiffeners placed at 6.0 ins pitch.

The rear pressure bulkhead is located at station 955 which is at the end of the passenger cabin. Its design is complicated by the access through it from the ventral door and stairs. A flat honeycomb sandwich panel construction is used. The L72 faceplates have a basic thickness of 0.016 ins and the core is 0.85 in deep. Light alloy I section forgings are used for the vertical and horizontal beams which bound the edges of the doorway. These vary in depth from 6 in to 10 ins and the vertical ones are laterally supported by horizontal cross members placed at 12.0 ins pitch. The horizontals are 2.25 in deep channels with 0.8 in flanges and a thickness of 0.04 in. The faceplates of the bulkhead panel are increased in thickness locally at the joints with the reinforcing members by the addition of reduced doubler plates.

The fin is attached to the fuselage at stations 937 and 999 by means of forged upper frame/fin spar root components. The tailplane box structure passes through the fuselage between stations 1042 and 1088 and a shear decking of reinforced 0.04 in L72 sheet is placed above it. The nose undercarriage is supported in forged light alloy fittings off the lower portion of frame 150.

Passenger and baggage doors use a double skin construction which is reinforced by zed section stiffeners. The baggage doors have three hinges along their upper edges and three locking pins along their lower edges. They are operated by hydraulic motors which drive through torque tubes and scissors links.

6.2 Wing

The greater part of the wing structure was designed by the case where the maximum constant rate of roll is associated with a normal acceleration of 1.67g at the design cruise speed, V_C . Fatigue was not found to introduce severe penalties.

At the root the wing box is of four spar construction. The spars are positioned at 10%, 36%, 56% and 85% of the chord, there being no flaps inboard of the lift engine nacelle. The aftermost spar is terminated at the inboard wall of the nacelle and the centre one of the remaining three at the outboard wall. The main end load carrying material consists of integrally machined zed section stringer cover panels. This configuration was chosen as the result of a cost-benefit analysis carried out by Dickinson (see Appendix A). DTD 5020A billets are used for the upper surface panels and the final skin thickness varies from 0.23 ins at the root to 0.1 in near to the tip. The access panels to the integral fuel tanks are load carrying and the skin has an approximately 50% greater thickness around them. At the inboard end the stringers are placed at 4 in pitch which decreases to 2.25 in at the tip. The proportions of the stringers vary from a depth of 2 in, free flange width of 0.6 in and thickness of 0.15 ins to corresponding values of 1.4 in, 0.5 in and 0.05 in outboard. The lower surface

panels have generally similar dimensions but the material used is DTD 5090. A spanwise joint is made in the covers at each spar and approximately mid way between them outboard of the nacelle only.

The spars are kinked in plan at rib station 53. This enables the centre wing box structure to pass across the top of the fuselage in line with the four attachment frames. At this rib the cover panels have a chordwise joint which consists of a large number of bolts in tension let into machined pockets in the skins. The rib itself is a bolted assembly of DTD 5020A machined items. The web is some 0.25 in thick with 0.325 in deep integral vertical stiffeners and the booms are separate angles. Bolts are used to attach the spar webs to corresponding faces on the fuselage frames and to connect the appropriate ribs to the three fuselage longitudinal members. Spar construction changes from root to tip, being based on DTD 5020A machined channel and I section inboard and built up from 0.08 in L72 plate outboard.

The fuel tank end ribs are all one piece machinings in DTD 5020A. They are of channel cross section typically with 0.055 in webs and 0.625 in wide booms. The webs are stiffened against pressure loads by 10 in pitch vertical legs. The flap attachment ribs are of similar design with 0.09 in thick webs. The stringers are interrupted at all the machined ribs but the detail design is such that the loads are carried across through cleats and bolts. The intermediate ribs are of pressed channel section L72 and are placed inside the stringers. The rib pitch is typically 20 in to 25 in.

The leading edge is not primarily load carrying structure. It is divided into a number of spanwise sections each of which is hinged to the top boom of the front spar so that there is ready access to the internal services. The aileron and spoiler support ribs aft of the outboard rear spar are forged L65 channel sections. A glass fibre reinforced plastic moulding is used for the wing tip.

A major complication in the design of the wing arises in the attachment of the large lift engine nacelle, which is aggravated by sweepback. The side webs of the nacelle coincide with wing ribs which are machined from DTD 5020A billets. A manufacturing joint is made on the outboard one. The difficulty of the sweepback geometry is overcome by introducing triangular shaped structural units at the outboard side of the front spar and inboard side of the rear spar. These result in an attachment structure which is more or less symmetrical as far as the nacelle is concerned. The triangular units are in effect boxes bolted up from machined DTD 5020A plates and extruded angle edge members.

6.2.1 Ailerons

The ailerons are divided into two sections on either side of the aircraft. The ultimate design load is 24,300 lb/side. Construction is conventional in that each section has two forged L65 hinge brackets mounted on the single spar. This is built up from 0.05 in thick L72 plate and extruded tee section L65 booms. All the ribs are pressed L72 channels. They have a mean pitch of 6 ins on the inboard section and 7 ins on the outer. The skins are 0.036 in L72 sheet.

6.2.2 Flap

The double slotted trailing edge flaps extend between the outboard nacelle sides and the ailerons. Both segments move over the same tracks of which there is a pair on each side of the aircraft. The tracks are machined I section in S99 steel and have a depth of 3.9 in and width of 1.0 in. The hardened steel rollers run over the upper and lower surfaces of the section whilst side loads are reacted by small rollers running along a 45° inclined inside face of the web. The general arrangement is shown in Figure 9. The tracks are bolted to the lower surface of the wing at the rear spar and supported off the top boom by a forged S99 I section strut.

Each segment of the flap has a single spar. Average rib pitch is 10 in on the forward segment and 6 in on the rear one. The 0.05 in L72 skins are reinforced by 0.064 thick zed section stiffeners which are located at 3 in pitch across the chord. The track rollers are mounted in self aligning bushes housed on forged bracket extensions from the machined L65 tee section track ribs.

The flaps are operated by recirculating ball screw actuators located some 8 in away from the track positions. The rear segment is driven from within the forward one and the main actuators by hydraulic motors through cross connecting torque tubes.

6.2.3 Spoilers

The spoilers are located over the top of the trailing edge flaps and have a hinge along the 63% chord line. The design load is 3740 lb/side, ultimate. There are two spoiler sections on each side of the aircraft and each has a pair of hinges and hydraulic actuators. The construction consists of 0.5 in full depth honeycomb with 0.08 in thick L72 faceplates. Light alloy inserts are placed in the core for hinge and actuator attachments.

6.3 Lift engine nacelle

The lift engine nacelles are 68.6 ft long, 9.1 ft wide and 5.0 deep. Each one houses six engines, three on either side of the wing attachment. The layout is shown in Figure 10. The volumes above and below the wing box structure are used as integral fuel tanks. The design case arises when two engines at either end of the nacelle fail and the remainder are overrated to 110% thrust.

Structurally each nacelle consists of two sidewalls connected by upper and lower shear decks. The sidewalls are fore and aft extensions from wing ribs and are basically of corrugated form in L73 sheet. Material thickness varies from 0.05 ins in the wing region to 0.03 ins at the extremities and the corrugations correspondingly from 2.2 ins to 1.75 ins width. The depth is constant at 1.5 ins. In the regions of the lift engine mounting trunnions the corrugations are replaced by integrally machined panels which carry the housings

for the trunnion bearing. Above and below the wing box the sidewalls are 0.23 in thick DTD 5020A machined panels. Both the upper and lower shear decks are also machined from DTD 5020A billets. They have large elliptical cutouts to give clearance to the lift engine intake and exhaust flows. Their total width is approximately 7.7 ft and the basic cross section is a channel with the edges machined with notches to match the sidewall corrugations. The web of the upper deck is 0.15 ins thick and that of the lower one 0.08 ins thick. The outer faces of the corrugations are attached to fore and aft extruded zed section booms. These provide both lateral and vertical bending strength and are some 5.25 ins wide with 2.4 ins by 0.8 ins flanges and a 0.15 ins thick web.

In the region above and below the wing the tank volumes are divided up into approximately cubic shapes to keep fuel pressures to a tolerable level. This is done by a series of 6.08 ins thick machined DTD 5020A webs with 6.0 ins pitch integral stiffeners. The nacelle to wing attachment is completed by triangular gusset assemblies which give a degree of symmetry to the arrangement and are built as part of the wing structure.

The upper and lower surfaces of the nacelles consist of engine bay doors and there are removable fairing panels along the sides to give access to the internal services placed on the sidewalls.

6.4 Tailplane

The ultimate tailplane design load of 64,000 lbs occurs when the aircraft is pitched to the 2.5g flight position at V_D and maximum weight.

The tailplane uses a two spar construction with the leading edge contributing to torsional stiffness. Rib pitch varies between 20 ins and 34 ins except in the leading edge where it is 10 ins. The interspar skin is in L73 sheet and is chemically etched in steps from a maximum thickness of 0.1 ins at the root to 0.07 ins at the tip. The leading edge skin is 0.055 ins thick. The 1.6 in deep zed section stringers are reduced to the skin. Their free flange width and thickness

varies from 0.5 ins to 0.4 ins and 0.05 ins to 0.036 ins respectively over the span.

The spars and covers are kinked at the sloping fuselage side rib which is a 1.0 in deep channel section DTD 5090 machining. Its web thickness varies from 0.25 ins to 0.14 ins and the boom from 0.6 ins to 0.15 ins. The attachment of the rear spar at frame 1088 is integral with the rib, and dagger forgings are employed to pass the stringer loads through the web. A built up assembly of 0.06 ins thick L72 plate webs and pressed back to back angle booms is used for the elevator hinge ribs. Vertical angle stiffeners are located at approximately 8 ins pitch across the web. The other ribs are also built up of 0.05 in plate webs and separate pressed angle booms. The stringers pass over the booms and are cleated to them. The spars are built up of L72 plate webs and extruded tee L65 booms.

6.4.1 Elevators

The elevator is built in four sections, two on each side of the aircraft. The total design load is 24,600 lb ultimate. Each section is hinged at two points, the inner one of which also carries the actuator attachment. The construction employs a single 0.05 in thick L73 pressed channel section spar. The ribs are also of pressed channel section, those at the hinge points being 0.028 ins and the other 0.022 ins thick. Chordwise lipped angle stiffeners are placed intermediately between the ribs. The L72 skins vary in thickness between 0.036 in and 0.022 ins. Forgings in L65 are used for the hinge fittings, the outboard one being designed to swing freely about a vertical hinge. The tip is of glass fibre reinforced plastic.

6.5 Fin

The maximum fin load arises during overswing following maximum rudder deflection at high speed and 12,000 ft altitude. The factored load is 143,000 lb.

The structural design of the fin is complicated by the fact that the propulsion engines are supported from it. The two spar locations at 15% and 54% of the chord were chosen primarily to suit the geometry of the engine attachments. The interspar ribs are placed normal to the 25° swept rear spar.

The lower fin is a relatively heavy construction with the cover panels machined from DTD 5020A billets. The stringers have a maximum thickness of 0.32 ins and are placed at 4 ins pitch whilst the skin varies in thickness from 0.2 ins at the root to 0.1 ins at the engine station. The spars are machined from the same material to an I section with 0.15 in webs. The spar root fittings are integral with the upper section of the attachment frames and are S99 forgings. A machined S99 forging is also used for the channel section root rib. This has a web thickness of 0.15 in.

The fin above the engine location is of built up construction with skins of L72 which vary in thickness from 0.13 ins to 0.05 ins. L73 zed section stringers are placed at 3 ins to 4 ins pitch across the chord. They range from 1.0 ins to 1.6 ins in depth and 0.04 ins to 0.08 ins in thickness. The spars are built up from 0.08 in L72 webs and extruded angle booms. The two rudder hinge ribs are built up from components of 0.064 ins thick L72 with an L65 forged actuator mounting bracket.

6.5.1 Rudder

The rudder is hinged at two points and has a single spar. The factored design load is 23000 lbs. The spar has a 0.06 ins thick L72 web with back to back L65 extruded angle booms and machined L65 hinge brackets. The 0.036 ins thick L72 skins are reinforced by 0.6 in by 0.06 in thick lipped angle spanwise stiffeners which are intercostal between the ribs, Their pitch varies between 2.5 ins and 5 ins.

Except at the lower hinge 0.05 ins thick L72 channel pressings are used for the ribs. At the lower hinge the rib has to react actuation loads and it is built up from L72 plate with extruded tee section booms.

6.6 Undercarriage

The undercarriage is of conventional tricycle layout with four tyres on a single axle on each mainwheel and twin nosewheels. The main undercarriage is mounted off the sides of the fuselage.

6.6.1 Main undercarriage

The general arrangement of the telescopic main undercarriage unit is shown in Figure 11. The design proof reaction factor is 1.5. The top of the leg is pivoted on a trunnion mounted between the two side extensions of fuselage frames. Retraction is inwards with the wheels rotating through 90° to lie with the axle fore and aft in the fuselage. The fairings necessary to accommodate the leg pivot structure are located below the emergency units and can be used as a platform during passenger egress.

The main components of the lower leg are S98 steel forgings, the axle and piston tube being a single piece. The upper part of the leg is fabricated in the form of a braced structure triangulated across to the ends of the pivot trunnion. The members of this are I section forgings in DTD 5034 light alloy. The folding side stay has a similar light alloy braced frame, also consisting of forged items, for its inboard portion. However the outboard part of the side stay is a simple I section steel forging in S99. The 90° rotation of the axle is achieved by using a steel spigot located at the top of the leg which moves in a cast light alloy camplate. The camplate is attached to the airframe. The torque links are forged in 7075-T73 light alloy.

Mechanical linkages are used to operate the undercarriage doors. The main door covers the wheels and is of 3 ins deep box construction in 0.05 ins and 0.06 ins L72 sheet. The outer door is shallower and uses a 1.0 in full depth honeycomb with 0.028 ins thick L72 faceplates.

6.6.2 Nose undercarriage

The nose undercarriage retracts forwards into a bay below the cockpit floor as is shown in Figure 12. The axle has 4 ins of trail. Maraging steel forgings are used for the single piece solid axle and lower leg, the torque links, the

centre steering tube and the steering plate. The main leg casing is an L65 light alloy forging which incorporates the side bracing to the lateral trunnion and attachment lugs for the combined drag strut/down lock and retraction jack. The main trunnions are located in spherical bushes contained in split housings attached to the bay sidewalls. The steering jack is attached to the top of the leg and operates on a peg on the steering plate which is itself splined onto the steering tube.

The down lock/drag strut is a 2 ins diameter lock pin which engages in a bracket carried off the nose undercarriage mounting frame. The pin is hydraulically unlatched but spring loaded for mechanical locking in the event of hydraulic failure. The clamshell bay doors are of light alloy box construction and are hydraulically operated.

7. POWERPLANT INSTALLATIONS

7.1 Propulsion engines

The propulsion engines are suspended from two lateral beams which extend laterally from the fin spars. The forward of the two is relatively short and is forged in S99. The inner sides of the engine fan casing attach to its ends by means of a connection which is illustrated in Figure 13. Loads in all three planes can be reacted. Each attachment bolt is held in a spherical self aligning bush. The rear beam is longer and shaped to pass over the engines to attach at points on the upper centrelines of the turbine casings. It is intended to react vertical and torque loads and is an I section forging in maraging steel. A forged angle bracket is employed to connect the beam to the rear spar of the fin.

The nacelle structure is of semi-monocoque construction and is based on pressed channel section ring frames placed at a pitch of 4.5 ins along its length. The lower half of the nacelle between the fan and turbine cases consists of a hinged access door. A stainless steel fireproof bulkhead is located between the compressor and combustion sections of each engine.

Air is tapped off the low pressure compressor for oil cooling and off the high pressure compressor for cabin air conditioning and tail surface deicing. The engine driven alternators and hydraulic pumps are positioned around the lower half of the fan casing with the other engine accessories. Engine starting is by compressed air supplied from an external source or the auxiliary power unit.

7.2 Lift engines

Each of the twelve lift engines is supported from the sidewalls of the nacelles by two trunnions. These react loads in all three planes as well as yawing and rolling moments. Pitching moments are reacted by the chain driven engine tilt system. The trunnions fit into a pair of tapered roller races which are positioned in housings integrally forged into the nacelle sidewalls.

The engine systems are as simple as possible, with a local total loss oil system in each unit and compressed air starting. There is no air offtake. The engine tilt mechanism consists of chains driving sprockets located on the ends of both trunnions on each engine. The chains in turn are driven by torque shafts which run longitudinally on both sides of each nacelle with bevel gearboxes for each engine drive. The torque shafts are connected to hydraulic motors. All services are located on the outside of the sidewalls, access to them being gained by removing the double skinned polyurethane filled side panels. Both the upper and lower doors are hydraulically operated. They are hinged along the edges of the sidewalls and split along the nacelle centreline. The top door uses double skins which consist of curved light alloy sandwich panels. The bottom doors are flat and have a full depth light alloy honeycomb construction.

7.3 Auxiliary power unit

The auxiliary power unit is located in the base of the fin above the fuselage tail cone. Its main support is by a pair of trunnions attached to a cradle extension above frame 1058. The cradle is built up of back to back pressed light alloy channel sections and is braced forward to the top of

frame 1042 by a pair of tubular light alloy struts. Vertical support to the front of the unit is given by a further pair of struts from the same attachment point.

The air intakes are positioned on the sides of the aft fin root fairing. They are provided with doors which are closed during normal flight when the unit is not operative. The auxiliary power unit drives an alternator and provides an emergency or ground running source of compressed air for cabin conditioning and engine starting.

8. SYSTEMS

8.1 Flying controls

The complication of transition from vertical to forward flight results in the need for auto controls and because of this a fully powered flying control system is used. All the flying control surfaces are hydraulically powered using a duplex supply system with an additional emergency backup. Each of the primary systems is supplied by a separate hydraulic pump located on one of the propulsion engines. Electrical power from the main electrical system or the auxiliary power unit is employed for the four emergency pumps. One of these is used for the conventional control surfaces and three for the lift engine tilt controls.

Each separate section of the primary control surfaces is operated by one double sided actuator, as is indicated in the schematic layout shown in Figure 14. In the case of the elevator and ailerons the actuator output is connected directly to the surface. The rudder installation is different in that a bell crank lever arrangement is used to give a compact installation within the fin aerofoil. It has two operating rods symmetrically placed relative to the rudder lower hinge. Each side of every actuator is supplied from different hydraulic systems with provision of an emergency line to either.

Two lift engine tilting hydraulic motors are located in each nacelle. They drive the two separate torque shafts and chain systems. Full lift engine tilt is available from either drive system. As the drive is rotary with a large

velocity ratio it is necessary to incorporate a differential follow up unit in the signalling lines to ensure that the tilt angle coincides with the pilot or autopilot demand.

Both pilot and autopilot demands are fed into the feel and variable gearing unit which is placed beneath the cockpit floor. From thence cable signalling is used with tension regulators at appropriate locations. Force limiting clutches are incorporated in the feel unit.

8.2 Fuel

The arrangement of the fuel system is shown in Figure 15. There are five main tanks and one surge tank in each half of the system with provision for cross feeding. Three of the main tanks are located within the main wing box structure whilst the other two are in the centre portion of the lift engine nacelle above and below the wing. All the tanks are integral with the structure. The centre of the three wing tanks is used as a collector and the fuel is fed from it to both the lift and propulsion engines by a pair of A.C. booster pumps. These booster pumps also drive jet pumps located in the opposite outer and inner wing tanks. Separate booster pumps lift the fuel from the nacelle tank to the collector. The pressure refuelling points are located under each wing just outboard of the lift engine nacelle. In-flight fuel jettisoning is done through nozzles placed in the wing trailing edge between the flaps and ailerons. The tank vent galleries lead into the surge tanks which are located in the wing outboard of the main tanks. A capacitance system is employed for fuel contents measurement together with fuel flowmeters.

8.3 Air conditioning

Air tapped from the high pressure compressors of the propulsion engines is the primary source for air conditioning of the cabin and equipment. Alternately it can be obtained from the auxiliary power unit or a ground source. The complete system is shown in Figure 16. An air to air heat exchanger is used for the initial cooling of the bled air, the cooling air is being diverted from the fan efflux.

Secondary cooling is by means of a boot strap system with a ram air cold air unit. During ground running cooling air is obtained by operating electrically driven fans placed in the ram air intakes. Auxiliary power unit or ground supply air joins the system at the secondary cooling stage. After cooling the air passes through a water extractor, humidifier and filters before entering a combined silencer/mixing unit. At this point the air from both of the two engine systems is combined with recirculated air before distribution.

The main components of the system are located in the rear fuselage on either side of the ventral doorway. The cabin air passes along ducts located just below the floor at the fuselage sides. From these ducts it is distributed by feeders which run up the cabin walls behind the trim. Distribution is at head level along the edges of the hat racks. Extraction of the air from the cabin is through vents placed along the centre of the cabin ceiling and the intersections of the walls and floor.

8.4 Deicing

A mixture of electric and hot air deicing is used in the design. Cyclically controlled electric heating is employed for the wing leading edges, windscreen and engine air intakes. The proximity of the tail surfaces to the propulsion engines led to the use of hot air deicing for the fin and tailplane leading edges. The air is tapped from the engines at the same points as that for the air conditioning system.

9. DISCUSSION AND CONCLUSIONS

9.1 Unusual design features

Apart from the fact that the aircraft is designed for vertical take off and landing it is conventional in most respects. However there are a few aspects of the layout which are worthy of discussion.

9.1.1 Lift engine installation

Once the decision had been taken to use a high mounted wing there was little choice with regard to the location of lift engines. Engines placed along the side of the fuselage in an extended sponson were ruled out because of the impingement of the jet efflux on the lower fuselage sides. The almost

inevitable use of nacelle mounted engines results in a significant weight penalty relative to a fuselage side installation due to the need to react engine mounting and lift loads back to the wing rather than directly into the fuselage. It is not possible to give an absolute figure for this penalty since no alternative design has been undertaken for comparison. However it is probably in the order of 3000 lbs which includes the additional triangular gusset structures necessary on the wing. The location of the nacelle well inboard and with its centre of mass forward of the local centre of twist of the wing box was chosen to avoid aeroelastic complexities of a type encountered on a previous design (Ref.1). This was confirmed by a preliminary analysis by Dickinson (see Appendix A), nor were there any undue fatigue problems in this case. A further difficulty associated with the large lift engine nacelles is the complexities of flow around the rear of the aircraft, especially in the region of the tailplane and propulsion engine air intakes. No detailed investigation of this was undertaken but problems can be anticipated. It is not possible to comment on the effect on overall aircraft drag.

9.1.2 Propulsion engine installation

The location of the propulsion engines on the sides of the fin is unusual. Although the lower fin structure is heavier because of this location no undue structural difficulties were encountered. It is thought that the intake airflow in cruise should be better than with a rear fuselage side installation and certainly it should enable a quieter aircraft to be designed. There is little point in using this engine location if the tailplane has to be mounted on the top of the fin. The installation weight would increase with higher bypass ratio due to the need to mount the engines higher and further out from the centreline.

9.1.3 Rear pressure bulkhead location

The layout of the rear fuselage of the aircraft was such as to introduce considerable difficulties in the design of the rear pressure bulkhead. The choice of a low tailplane position in conjunction with a ventral stairway resulted in the

bulkhead being located at the end of the cabin rather than aft of the stairway. Thus whilst the ventral door is unpressurised the bulkhead includes a pressure door and is of relatively large size. Although various structural configurations for the bulkhead were considered the use of a heavy, flat design was found to be inevitable. It is possible that a redesign of the rear fuselage would overcome this difficulty but some extension of overall length would seem to be necessary.

9.2 Vertical take off penalty

The predicted all up weight of the aircraft of 125,000 lbs is some 25 per cent greater than what would be expected for a conventional take off and landing aircraft of similar range and payload performance. The design is more complex due to the need to cater for transition and vertical as well as conventional flight and so it can be concluded that the aircraft would be more expensive to operate.

The advantages of vertical take off and landing are potentially great, but the penalties to be paid for these advantages are significant. It is outside the scope of the investigation to attempt to draw quantitative conclusions but the main issue appears to be the extent to which the advantages can be realised within a practical route network. It is also pertinent to question whether they are really required for short haul traffic in the predictable future. This is discussed, for example, by Brown (Ref.2).

9.3 Conclusions

9.3.1 The provision of vertical take off and landing ability on an aircraft confers potentially great advantages upon it. However the weight, operational and cost penalties are significant and the justification for this class of aircraft requires further investigation.

9.3.2 The mounting of the lift engines in separate nacelles introduces a weight penalty relative to fuselage side sponson mounting. In the case of the layout used there were no significant aeroelastic or fatigue problems.

9.3.3 The installation of the propulsion engines on the vertical fin does not give rise to any undue structural difficulties.

9.3.4 The mounting of the tailplane relatively low on the fuselage together with the provision of a ventral stairway resulted in rear fuselage layout difficulties. These necessitated the use of a large, flat rear pressure bulkhead, but a revised layout might obviate this.

REFERENCES

1. HOWE, D. Aeroplane Design Studies - Conventional
 and V.T.O.L. Freighter Aircraft.
 College of Aeronautics Report Aero No.171
 Nov. 1963
2. BROWN, D.G. The case for V/S.T.O.L. aircraft in
 short-haul transportation.
 Hawker Siddeley Aviation April 1970

TABLE 1

Component Weights

COMPONENT	WEIGHT lb	A.U.W. %
Wing, including lift nacelle attachment	11150	8.92
Fuselage	11500	9.20
Lift engine nacelle structure and doors	5960	4.77
Tailplane	1880	1.51
Fin, including propulsion engine attachment	1620	1.29
Main undercarriage	2780	2.23
Nose undercarriage	610	0.48
Structure	35500	28.40
Propulsion engines	7000	5.60
Cowlings, nacelle structure, etc.	900	0.72
Engine controls, systems	500	0.40
Propulsion Engines Group	8400	6.72
Lift engines	11620	9.30
Engine controls, systems, etc.	1500	1.20
Lift Engines Group	13120	10.50
Fuel system	1250	1.00
Power supply systems, including APU	4380	3.51
Flying controls	1870	1.49
Deicing system and fire precautions	830	0.66
Air conditioning system	1500	1.20
Systems	9830	7.86

continued.

Table 1 continued

COMPONENT	WEIGHT lb	A.U.W. %
Radio and radar installation	1500	1.20
Instruments	600	0.48
Installations	2100	1.68
Sound proofing	1000	0.80
Flight crew furnishings	400	0.32
Cabin furnishings	1880	1.51
Cabin seats	2500	2.00
Miscellaneous cabin items, water system, etc.	1870	1.50
Furnishings	7650	6.13
Basic Operating Weight	76600	61.29
Passenger service items and expendables	1250	1.00
Crew	1100	0.88
As prepared for service weight	78950	63.17
Passengers, 108	21600	17.27
Fuel	24450	19.56
All Up Weight	125000	100.00

TABLE 2

Moments of Inertia

(Relative to $0.3\bar{c}$ and 3.5 ft above fuselage datum)

Configuration	Moment of Inertia 10^6 lb ft ²		
	Pitch	Roll	Yaw
As prepared for service 78950 lb	45	12	53
Increment due to 108 passengers 21,600 lb	8	1	7
Increment due to 24450 lb fuel	1	10	11

TABLE 3

Aerofoil Section Ordinates
(10% Thickness Chord Ratio)

% Chord	2% Camber		Symmetrical
	Upper Ordinate	Lower Ordinate	Depth
0.75	1.34	1.02	2.25
1.25	1.89	1.34	2.8
2.5	2.36	1.66	3.85
5.0	3.23	2.21	5.25
7.5	3.86	2.60	6.3
10	4.33	2.76	7.05
15	4.97	3.15	7.75
20	5.43	3.47	9.05
25	5.75	3.63	9.5
30	5.98	3.78	9.85
35	6.16	3.87	9.98
40	6.15	3.72	9.95
45	6.06	3.55	9.65
50	5.83	3.31	9.16
55	5.43	2.99	8.4
60	5.04	2.68	7.6
65	4.48	2.21	6.8
70	3.94	1.97	5.75
75	3.39	1.65	4.85
80	2.83	1.34	3.85
85	2.13	0.87	2.95
90	1.42	0.63	2.03
95	0.72	0.30	1.0
100	0	0	0

APPENDIX A

Allocation of components for A 70 study

Allen, F.D.	Tailplane structure
Ames, M.L.	Fuel system
Arora, V.P.	Aileron structure
Barnes, W.H.	Main undercarriage
Bidwell, G.J.	Rear fuselage structure
Bolan, G.P.	Fin structure
Brookes, C.M.	Centre fuselage structure
Cheetham, J.P.	Lift and propulsion engine installation.
Coombs, P.R.	Lift engine nacelle structure
Coughlin, S.	Rudder structure
Davies, W.B.	Flying control system
Dickinson, J.A.	Outer wing structure and wing aeroelasticity
Horrell, M	Speed brake/spoilers
Jones, G.P.	Inner wing structure (nacelle region)
Keech, B.R.	Nose undercarriage
Micklefield, R.F.	Front fuselage structure
Millman, A.F.	Elevator structure
Richmond, S.	Trailing edge flap mechanism and structure
Simpson, D.S.	Centre wing structure and wing fatigue.
Turner, J.	Air conditioning and de-icing systems.

APPENDIX B Specification

1.0 Geometry

1.1 Wing

Gross area	1000 sq ft.
Span	77 ft.
Aspect Ratio	5.9
Leading edge sweepback	28°
Root chord (centreline)	19.32 ft.
Tip chord (nominal)	6.82 ft.
Standard mean chord, \bar{c}	13.07 ft.
Aerofoil sections:	
Root 13% thickness at 0.375c, symmetrical	
Tip 10% thickness at 0.375c, symmetrical	
Linear variation, see Table 3.	
Wing-body angle (centreline chord to body datum)	3°
Dihedral, in wing plane	0°
Location of 0.25 \bar{c} aft of fuselage nose	51.5 ft.
Location of 0.25 \bar{c} aft of centreline leading edge	12.2 ft.
Distance of 0.25 \bar{c} above fuselage datum, centreline of aircraft and wing chord plane	5.53 ft.

1.2 Trailing edge flaps (See Figure 9)

Type: Double slotted	
Total flap chord/wing chord	0.30
Subsidiary nose flap chord/total flap chord	
upper surface	0.20
lower surface	0.10
High lift flap setting	15° + 15°
High lift and drag flap setting	45° + 15°
Inboard end of flap from aircraft centreline	18.7 ft.
Outboard end of flap from aircraft centreline	30.0 ft.

1.3 Ailerons

Type: 20% control chord nose balance	
Aileron chord/wing chord	0.25
Movement	±20°
Inboard end relative to aircraft centreline	30.2 ft.
Outboard end relative to aircraft centreline	38.5 ft.

1.4	<u>Speed Brake/Spoiler</u>	
	Spoiler chord/wing chord	0.1
	Movement relative to local surface	30°
	Leading edge of spoiler aft of wing leading edge	0.66c
	Inboard end relative to aircraft centreline (leading edge)	18.7 ft.
	Outboard end relative to aircraft centreline (leading edge)	30.0 ft.
1.5	<u>Tailplane</u>	
	Gross area	277 sq ft.
	Span	33.3 ft.
	Aspect Ratio	4.0
	Sweepback of leading edge	28°
	Root chord (centreline)	10.42 ft.
	Tip chord (nominal)	6.25 ft.
	Aerofoil section:	
	10% thickness at 0.375c, symmetrical	
	See Table 3.	
	Dihedral	0°
	Movement	+0° up -5° down
	Vertical location of tailplane above fuselage datum	0 ft.
	Distance of centreline chord leading edge aft of fuselage nose	82.7 ft.
1.6	<u>Elevator</u>	
	Type: Round nose	
	Elevator chord/tailplane chord	0.25
	Movement	+15° down -25° up
	Inboard end of elevator hingeline from aircraft centreline	2.1 ft.
1.7	<u>Fin</u>	
	Nominal area above fuselage datum	280 sq ft.
	Area above fuselage cross section- aerodynamic reference area	205 sq ft.
	Height above fuselage datum	22.9 ft.
	Aspect ratio based on area above fuselage datum	1.87
	based on area above fuselage	1.63

	<u>Fin</u> continued	
	Chord on fuselage datum	17.1 ft.
	Tip chord (nominal)	7.4 ft.
	Sweepback of leading edge	35°
	Aerofoil section: 10% thickness at 0.375c, symmetrical See Table 3.	
	Distance of leading edge intersection with fuselage datum from fuselage nose	71.9 ft.
1.8	<u>Rudder</u>	
	Type: Round nose	
	Rudder chord/fin chord	0.4
	Height of rudder root above fuselage datum	11.66 ft.
	Movement	±20°
1.9	<u>Fuselage</u> (See Fig. 2)	
	Overall length	94.2 ft.
	Maximum diameter	12.5 ft.
	Maximum cabin internal width	11.65 ft.
	Cabin height on centreline	6.5 ft.
	Cabin length, overall	67.3 ft.
1.10	<u>Lift Engine Nacelles</u> (See Fig.12)	
	Overall length	65.8 ft.
	Maximum width	8.0 ft.
	Maximum depth	5.0 ft.
	Distance of nacelle nose aft of fuselage nose	19.3 ft.
	Distance of nacelle centreline from aircraft centreline	14.5 ft.
	Height of nacelle datum above bottom of nacelle	1.67 ft.
	Height of nacelle datum above fuselage datum	4.67 ft.
1.11	<u>Undercarriage</u> (See Fig.10)	
	Type: Nosewheel	
	Wheelbase	43.8 ft.
	Track (to centre of mainwheel unit)	13.3 ft.

Main Undercarriage unit

4 wheel side by side arrangement

Tyres: 34 in dia. x 9.25 in wide - 16 in rim.

Tyre pressure 150 p.s.i.

Track over inner pair of wheels 3.35 ft.

outer pair of wheels 7.35 ft.

Static tyre closure 0.25 ft. approx.

Maximum tyre closure 0.5 ft. "

Location of main undercarriage leg aft
of fuselage nose 4.58 ft.

Nosewheel unit (See Fig. 11)

Twin wheels

Tyres: 34 in dia. x 9.25 in wide - 16 in rim.

Tyre pressure 150 p.s.i.

Wheel track 1.5 ft.

2.0 Power Plants

2.1 Propulsion Engines

Type: Three shaft bypass jet engine

Installation: 2 fin mounted pods

Bypass ratio 5

Sea Level Static Thrust 21,500 lb.

Overall length of pod 11.1 ft.

Intake diameter 5.3 ft.

Maximum diameter of pod 6.5 ft.

Location of engine centreline above
fuselage datum 9.25 ft.

Location of engine centreline from aircraft
centreline 4.0 ft.

Location of pod front face aft of fuselage
nose 76.1 ft.

2.2 Lift Engines

Type: RB 202 fan engine derivative

Installation: 2 nacelles each with 6 engines.

Sea level static thrust 14,500 lb.

Overall diameter 7.3 ft.

Overall depth 3.7 ft.

Distance of mounting trunnion from intake face 2.92 ft.

Lift Engines continued

Fore and aft location of engines
(see Fig.12)

Tilt angle, fore and aft $\pm 25^{\circ}$ aft
 $\pm 15^{\circ}$ forward

2.3 Auxiliary Power Unit

Type: Garret-Airesearch GTCP-85C

3.0 Weights, Centres of Gravity and Moments of Inertia

Design normal weight at take off	125,000 lb.
Maximum landing weight	120,000 lb.
Minimum flying weight	80,000 lb.
As prepared for service weight	78,950 lb.
Maximum payload	24,000 lb.
Maximum fuel load	35,000 lb.

Weight breakdown - see Table 1

Centre of Gravity at A.P.S. Weight, relative
to 0.25c and fuselage datum:-

Undercarriage Retracted	\bar{x} = 2.30 ft aft
	\bar{z} = 3.57 ft above
Undercarriage Extended	\bar{x} = 2.20 ft aft
	\bar{z} = 3.45 ft above

Allowable centre of gravity range 1.0 ft forward to
1.7 aft of datum

Moments of Inertia - see Table 2.

4.0 Aerodynamic Information

Maximum lift coefficients (untrimmed):-

Basic wing	1.2
Flaps at high lift setting, see 1.2	1.65
Flaps at high drag setting, see 1.2	1.8
Normal flight maximum (1.22 V_S)	1.2

Drag polars:-

Cruise at $M = 0.80$ and 20,000 ft. $C_D = 0.0297 + 0.091C_L^2$

$M = 0.4$ and sea level $C_D = 0.0245 + 0.066C_L^2$

Take off, high lift configuration sea level

$$C_D = 0.083 + 0.06(C_L - \Delta C_L)^2 + 0.19\Delta C_L^2$$

Landing, high drag configuration, sea level

$$C_D = 0.127 + 0.06(C_L - \Delta C_L)^2 + 0.19\Delta C_L^2$$

(where ΔC_L is the increment due to flap)

Pitching moment coefficient

Clean aircraft	-0.09
High lift configuration	-0.26
High drag configuration	-0.35
Forward movement of aerodynamic centre due to body and nacelle effects	1.45 ft.
Location of low speed overall wing-body aero. centre from fuselage nose	50.4 ft.
Location of mean tailplane zero. centre aft of fuselage nose	88.7 ft.
Location of mean fin aero. centre aft of fuselage nose	85.0 ft.
Wing no lift angle, clean, relative to wing centreline chord	-1°
Slope of wing body lift curve, a_1 . See Fig.5	
Slope of aileron hinge moment curve due to wing incidence, b_1	-0.27
Slope of aileron hinge moment curve due to aileron angle, b_2	-0.68
Slope of tailplane lift curve, a_{1T} . See Fig.5	
Ratio of elevator lift curve slopes, a_{2T}/a_{1T}	0.61
Slope of elevator hinge moment curve due to tailplane incidence, b_{1T}	-0.22
Slope of elevator hinge moment curve due to elevator angle, b_{2T}	-0.64
Slope of fin lift curves, a_{1F} (net) a_{1BT} (with body and tail effects) (See Fig.5)	
Ratio of rudder lift curve slopes a_{2F}/a_{1F}	0.31

Slope of rudder hinge moment curve due to fin incidence, b_{1F}	-0.32
Slope of rudder hinge moment curve due to rudder angle, b_{2F}	-0.61
Slope of lift decrement due to operation of spoilers/speed brakes	-0.19
Slope of drag increment due to operation of spoiler/airbrakes	0.014

Downwash angle at tailplane. See Fig.7

Rolling moment coefficients:-

Due to aileron angle, l_{ξ}	} See Fig.6
Due to rolling, l_p	
Due to sideslip l_v	$- [0.060 + 0.14C_L + (0.033 - 0.061C_L)] a_{1BT}$
Due to yawing l_r	$a_{1BT}(0.03 - 0.055C_L) + 0.21C_L$

Yawing moment coefficients:-

Due to sideslip n_v	$0.13a_{1BT} - 0.09$
Due to yawing n_r	$[-0.07 + 0.115a_{1BT} + 0.018C_L^2]$

Side force coefficient due to sideslip, y_v $- [0.3 + 0.28a_{1BT}]$

Tailplane rolling moment coefficient due to sideslip, K_{β} 0.15

(Note all derivatives are based on the reference dimensions and areas quoted at paragraph 1. Hinge moment coefficients only are based on control surface area and chord aft of the hinge line. All angular measure is in radians unless otherwise stated).

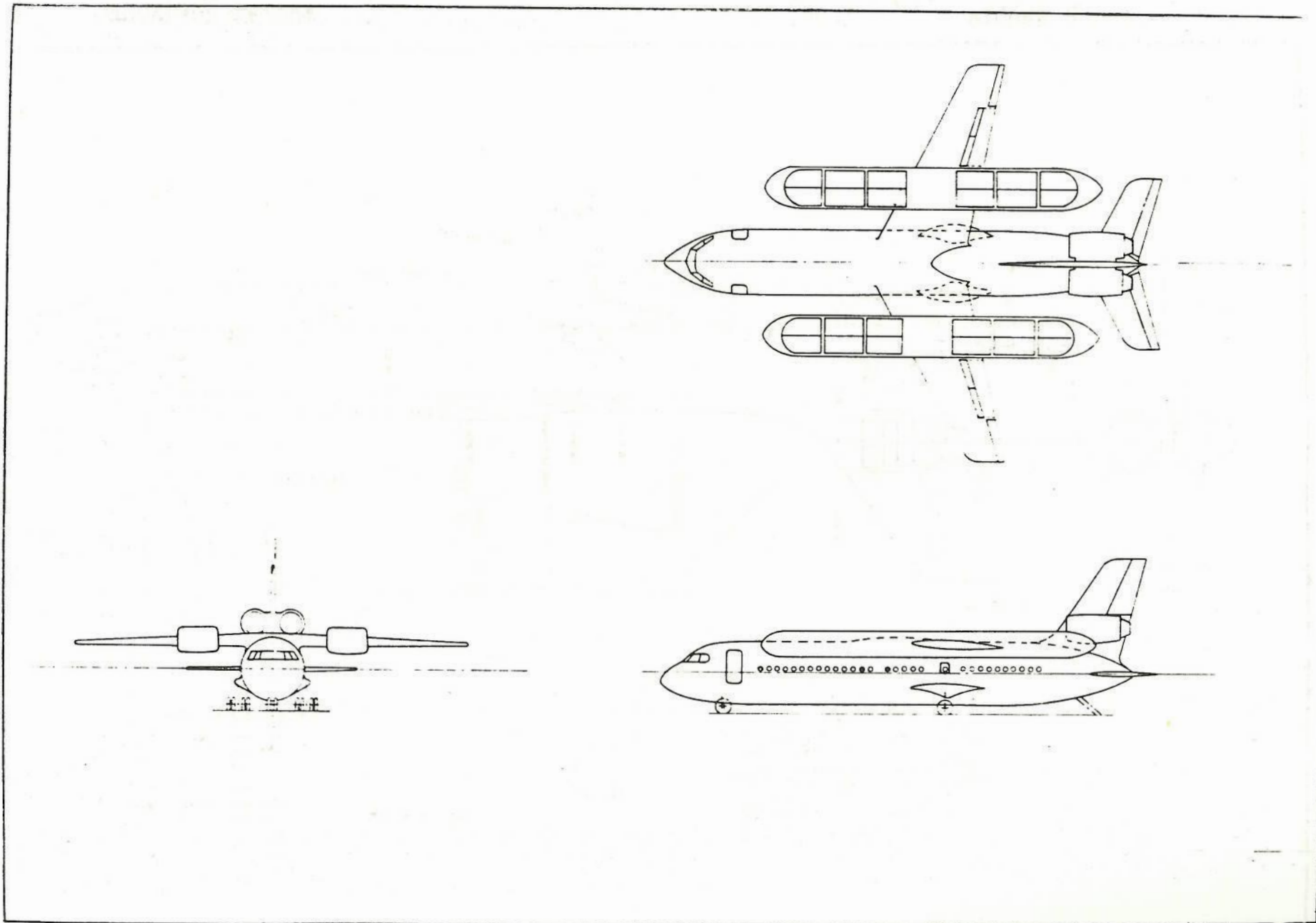

GENERAL ARRANGEMENT OF THE A-70

FIGURE 1.

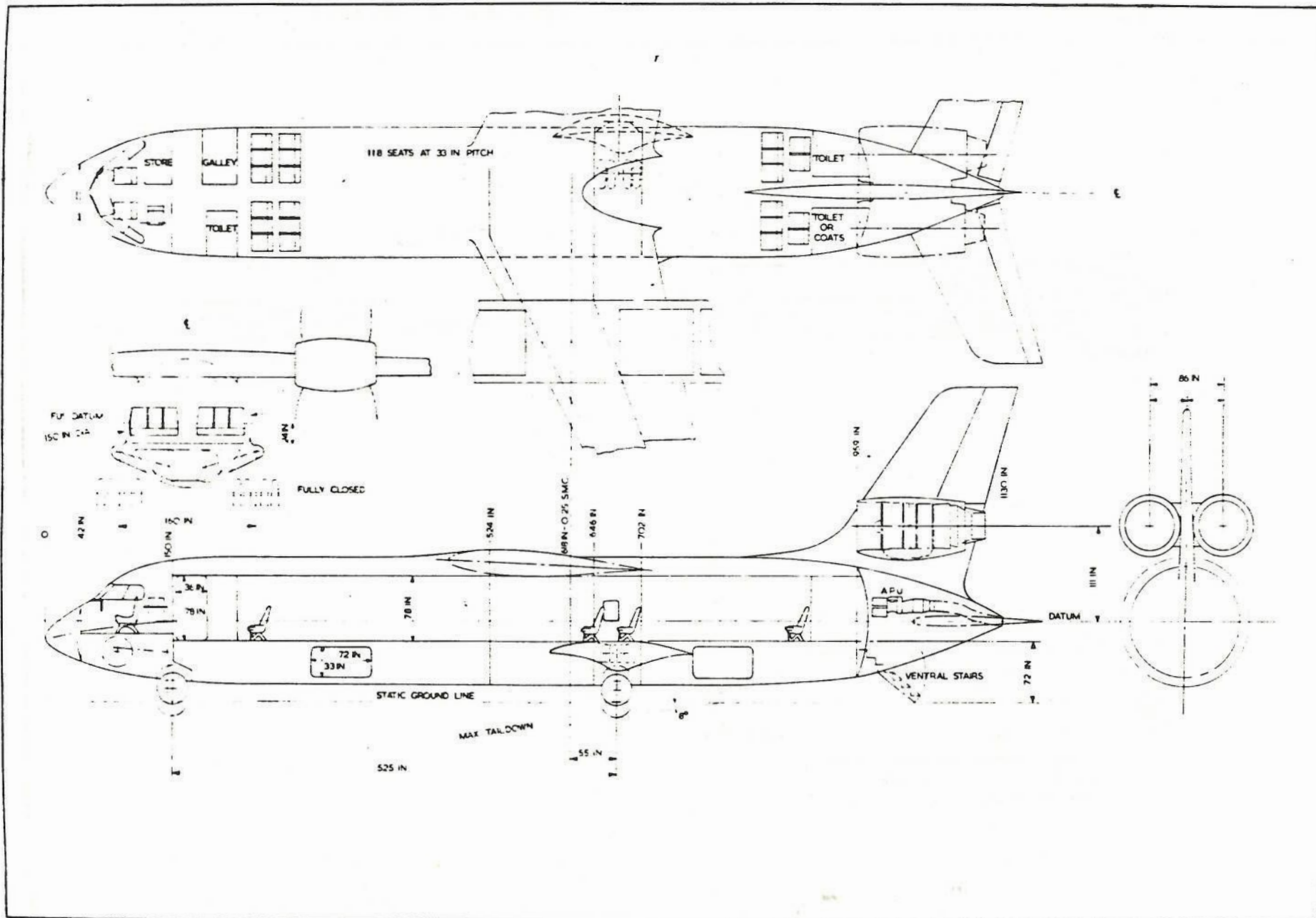

FUSELAGE LAYOUT

FIGURE 2

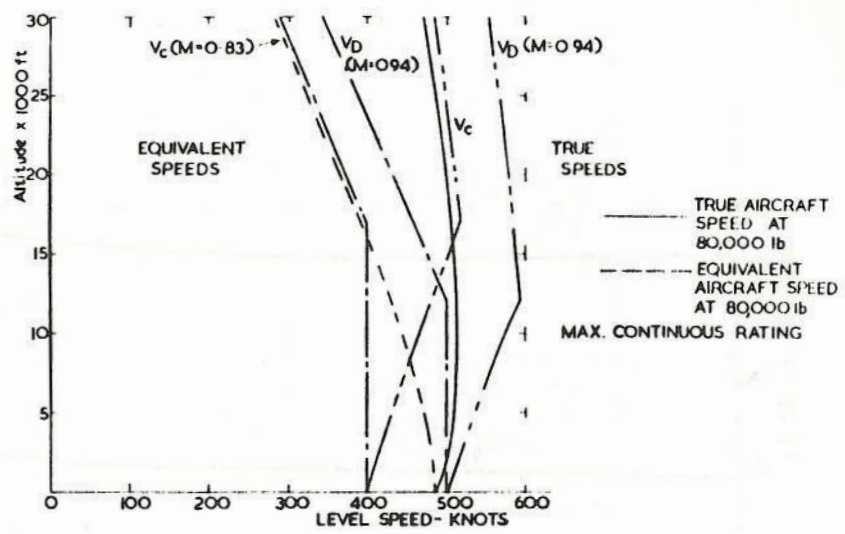

LEVEL FLIGHT SPEEDS

FIGURE 3

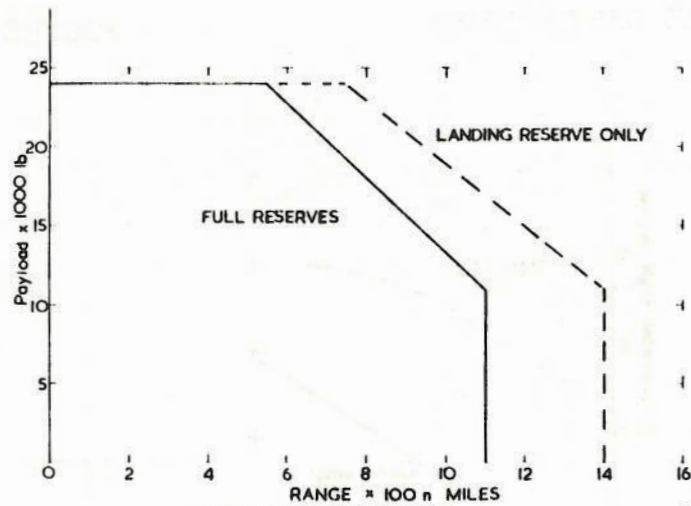

PAYLOAD-RANGE DIAGRAM

FIGURE 4

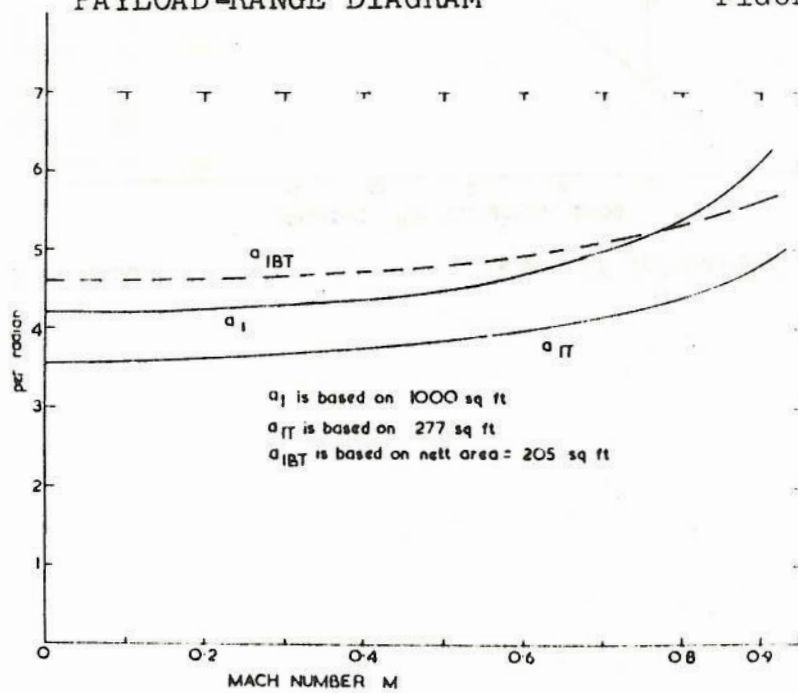

LIFT CURVE SLOPES

FIGURE 5

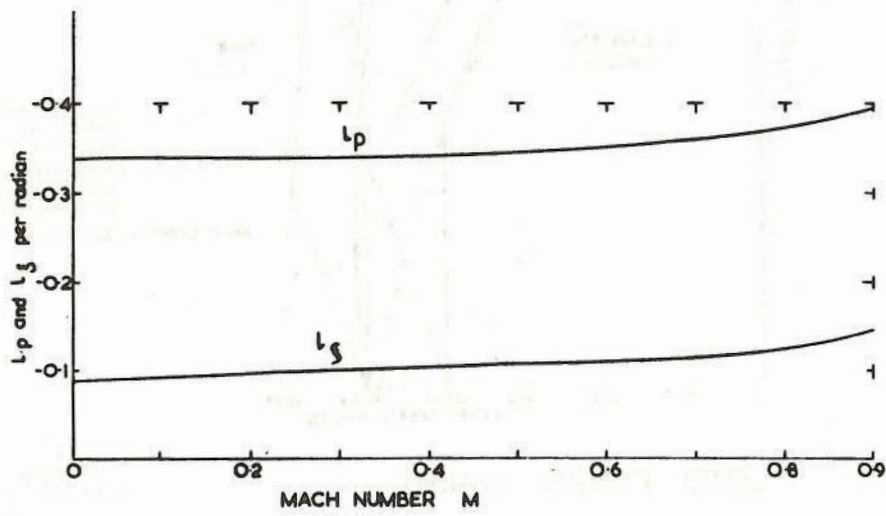

ROLL DERIVATIVES

FIGURE 6

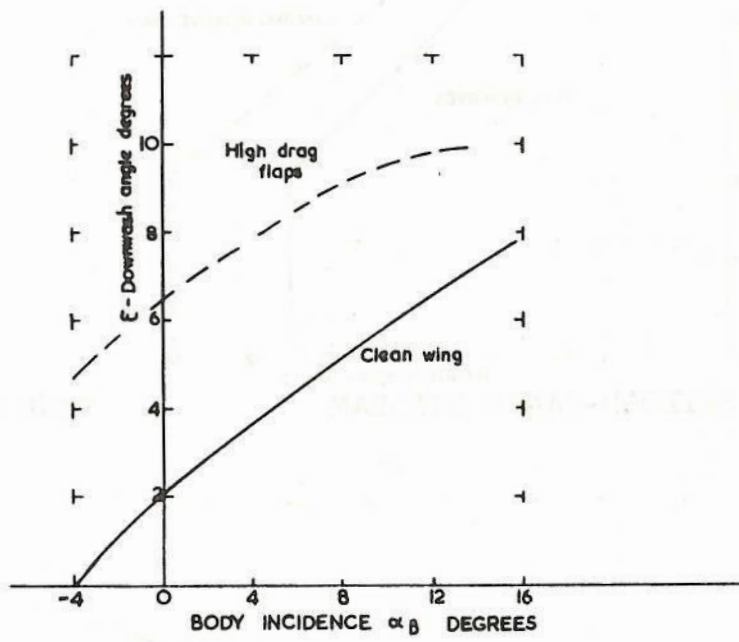

DOWNWASH AT TAIL

FIGURE 7

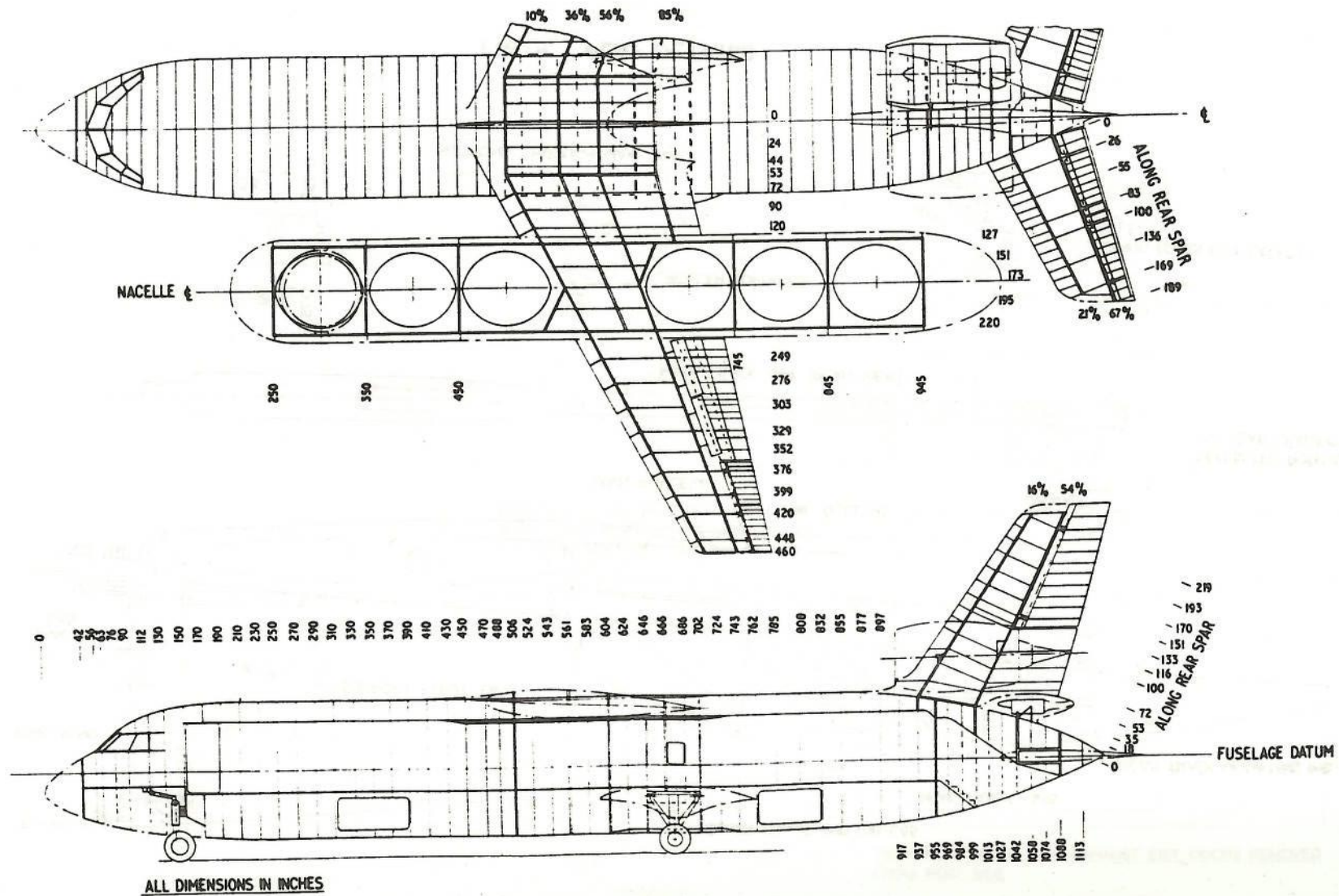

FIG. 8. KEY STRUCTURAL DRAWING

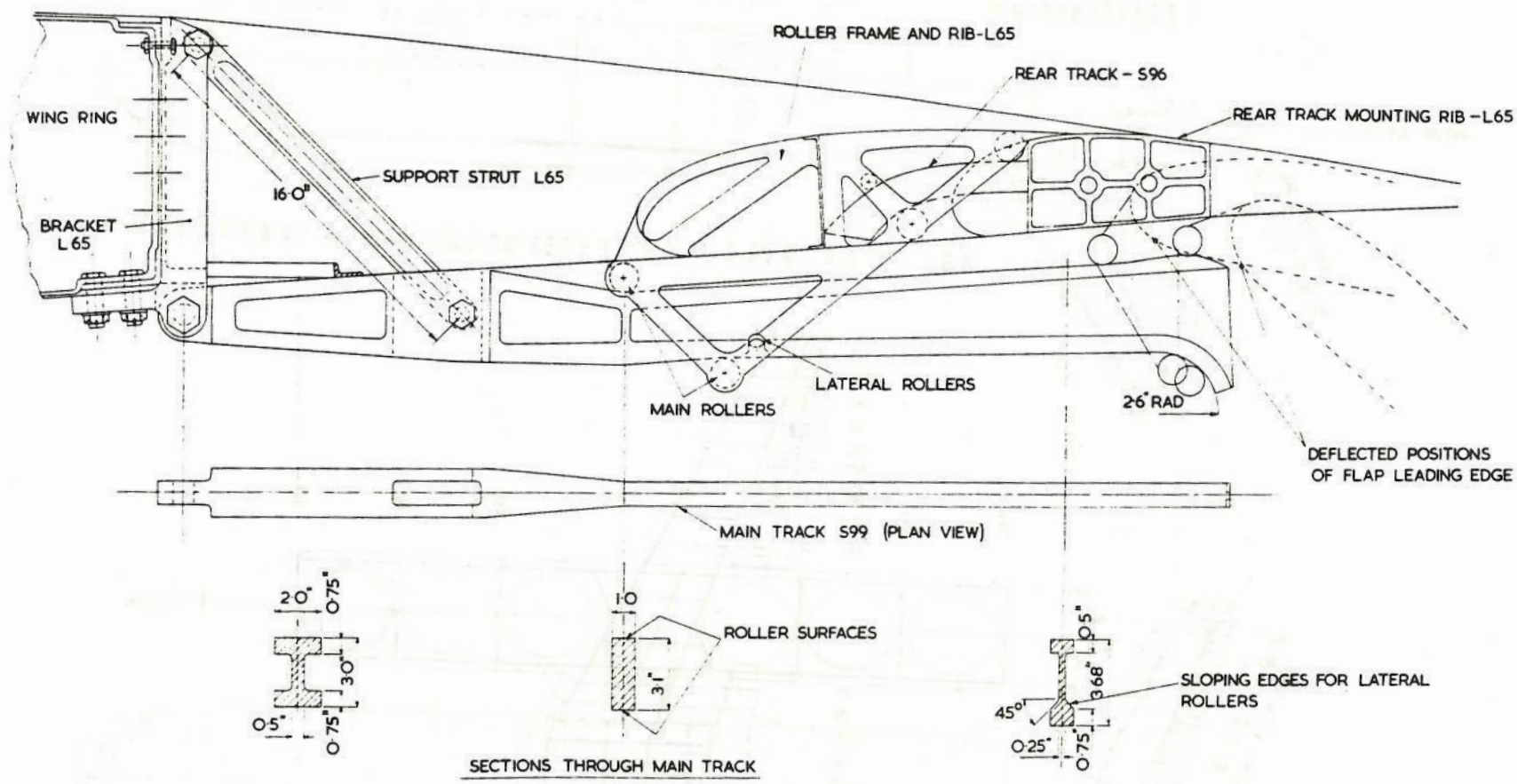

FIG. 9. FLAP DETAILS

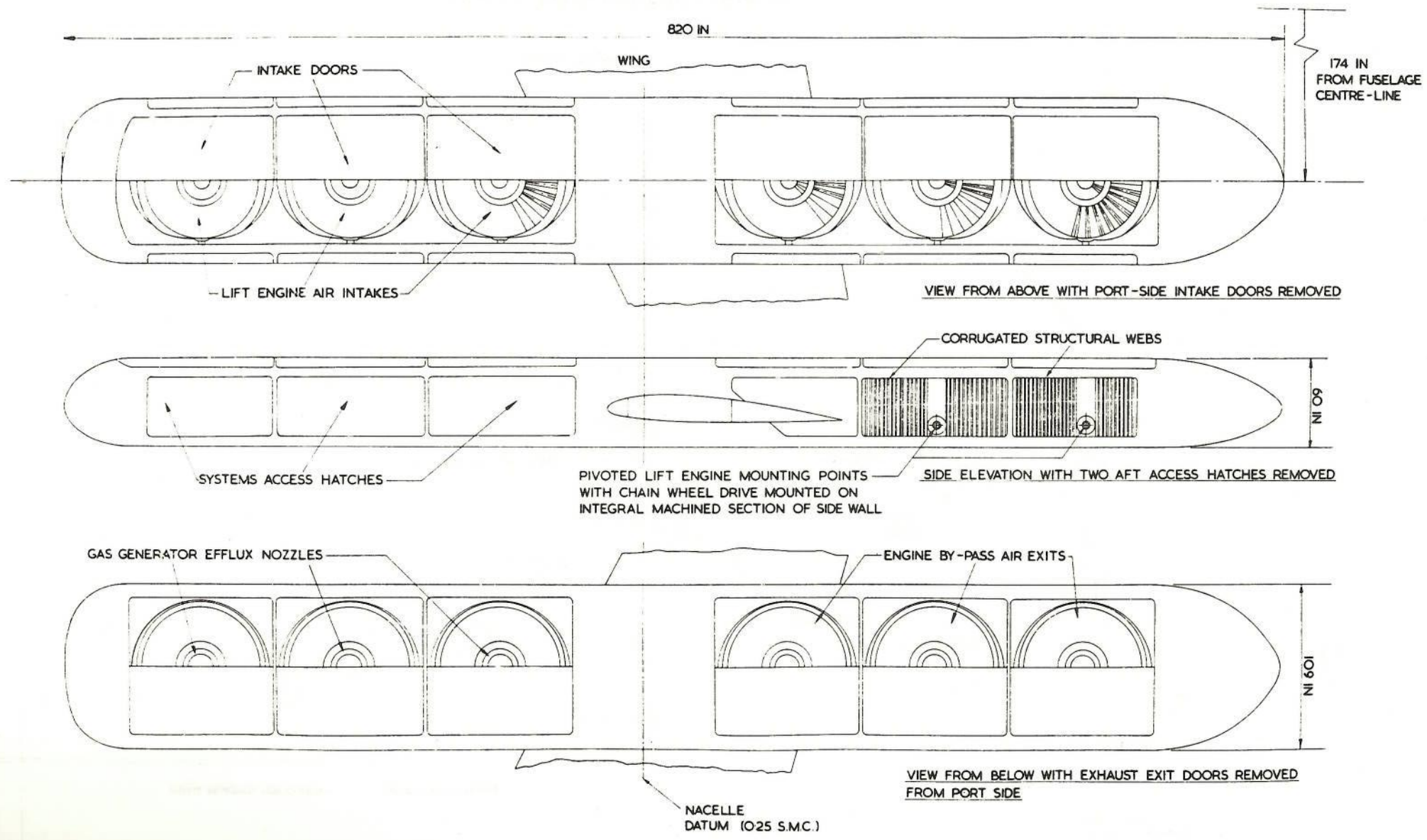

FIG. 10. LIFT ENGINE NACELLE

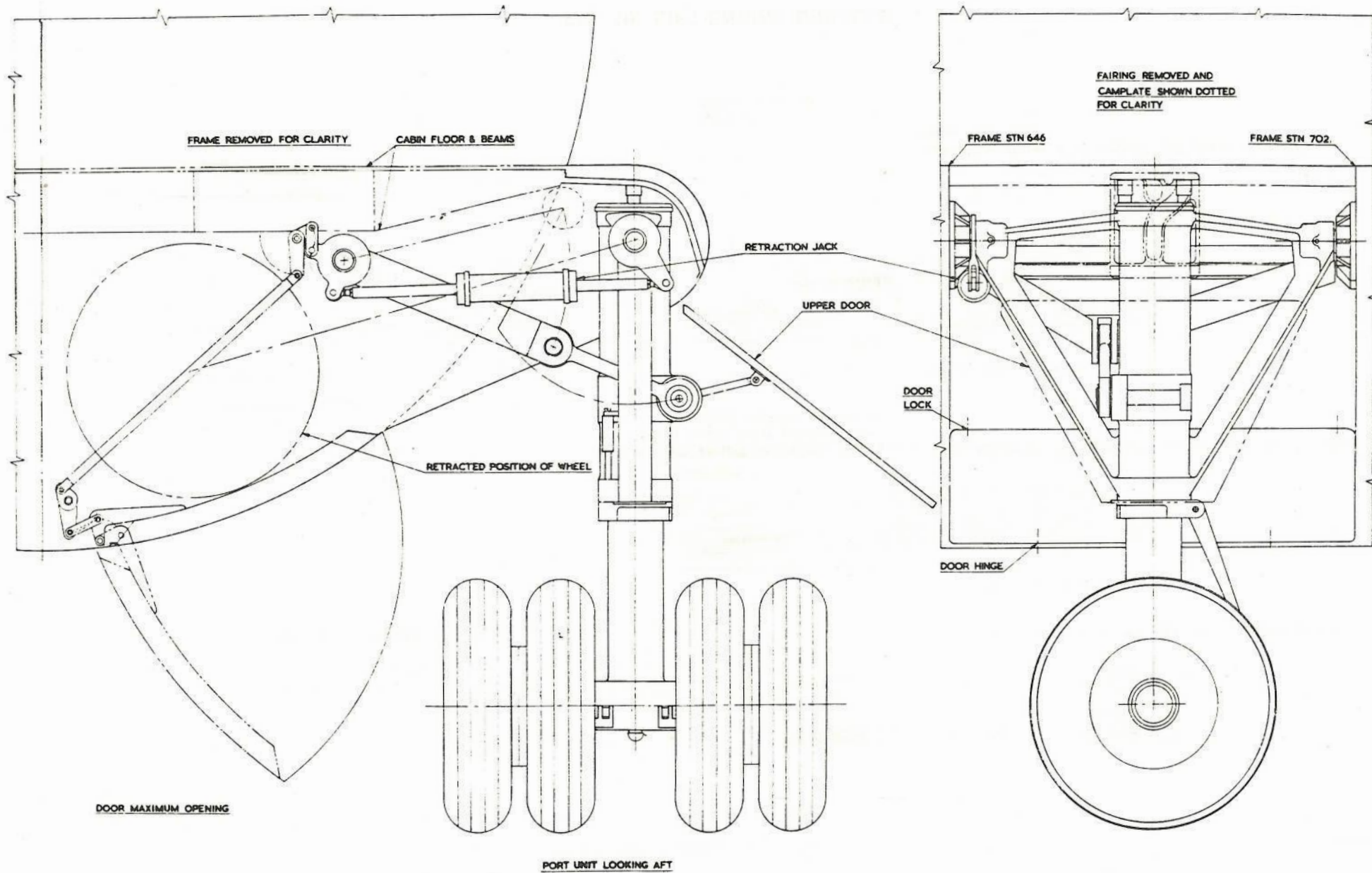

FIG. 11. MAIN UNDERCARRIAGE

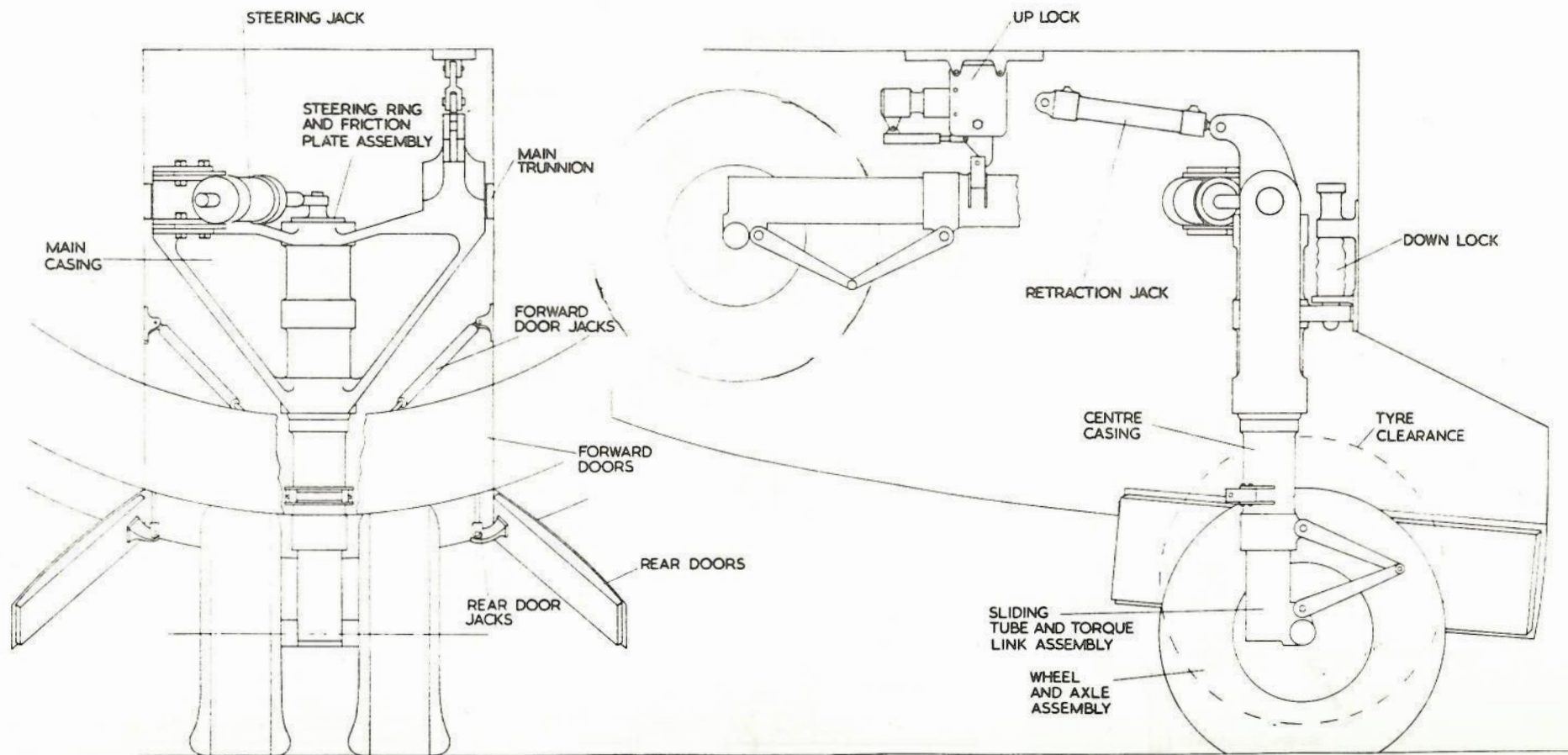

FIG. 12. NOSE UNDERCARRIAGE

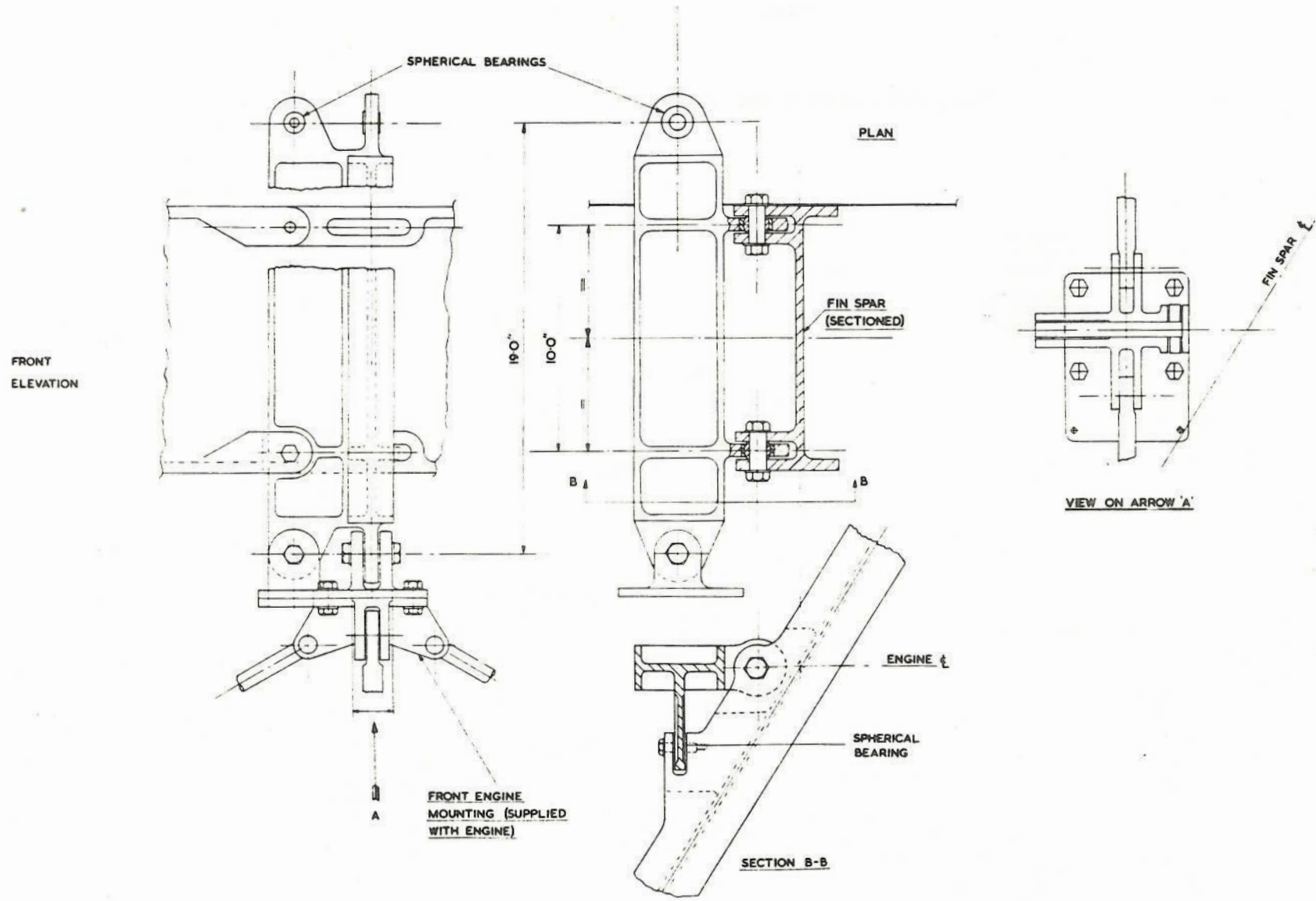
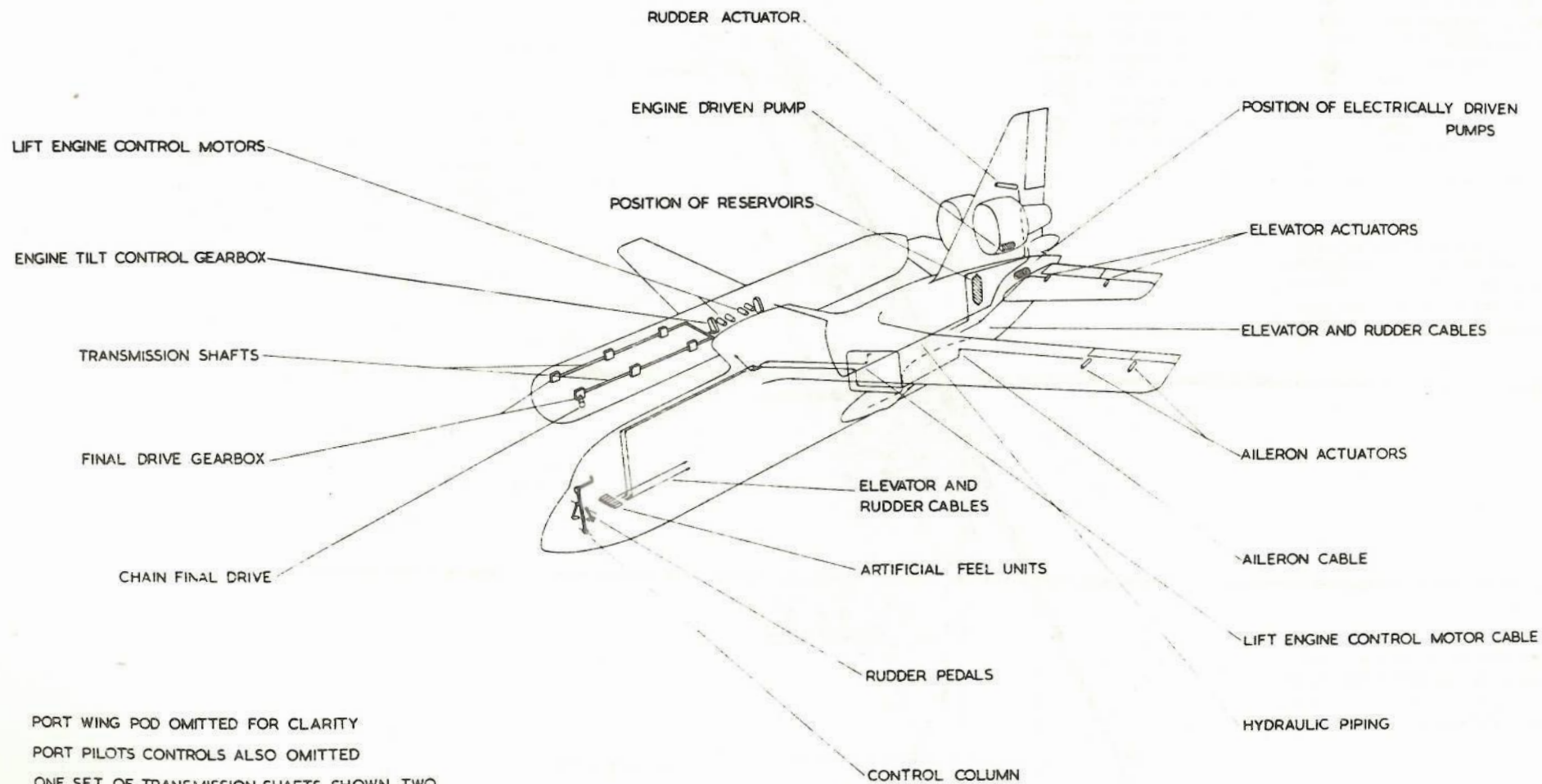

FIG. 13. FRONT PROPULSION ENGINE MOUNTING



PORT WING POD OMITTED FOR CLARITY

PORT PILOTS CONTROLS ALSO OMITTED

ONE SET OF TRANSMISSION SHAFTS SHOWN, TWO
SETS IN EACH POD

ONLY ONE SET OF LIFT ENGINE CONTROL MOTORS SHOWN

REPRESENTATIVE CABLES, PIPES, PUMPS, CHAIN DRIVES

AND RESERVOIR ONLY, SHOWN

FIG. 14. FLYING CONTROL SYSTEM

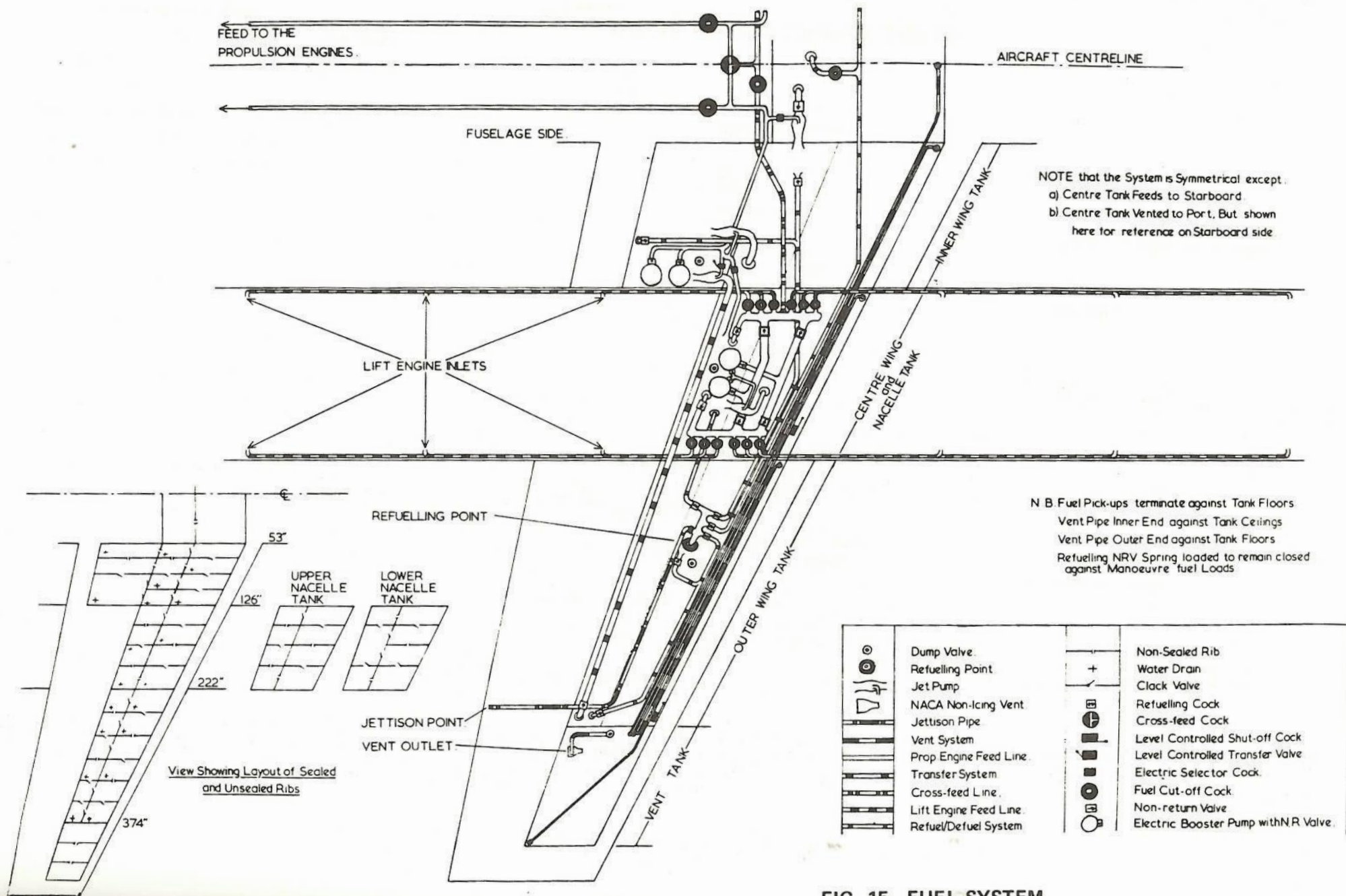
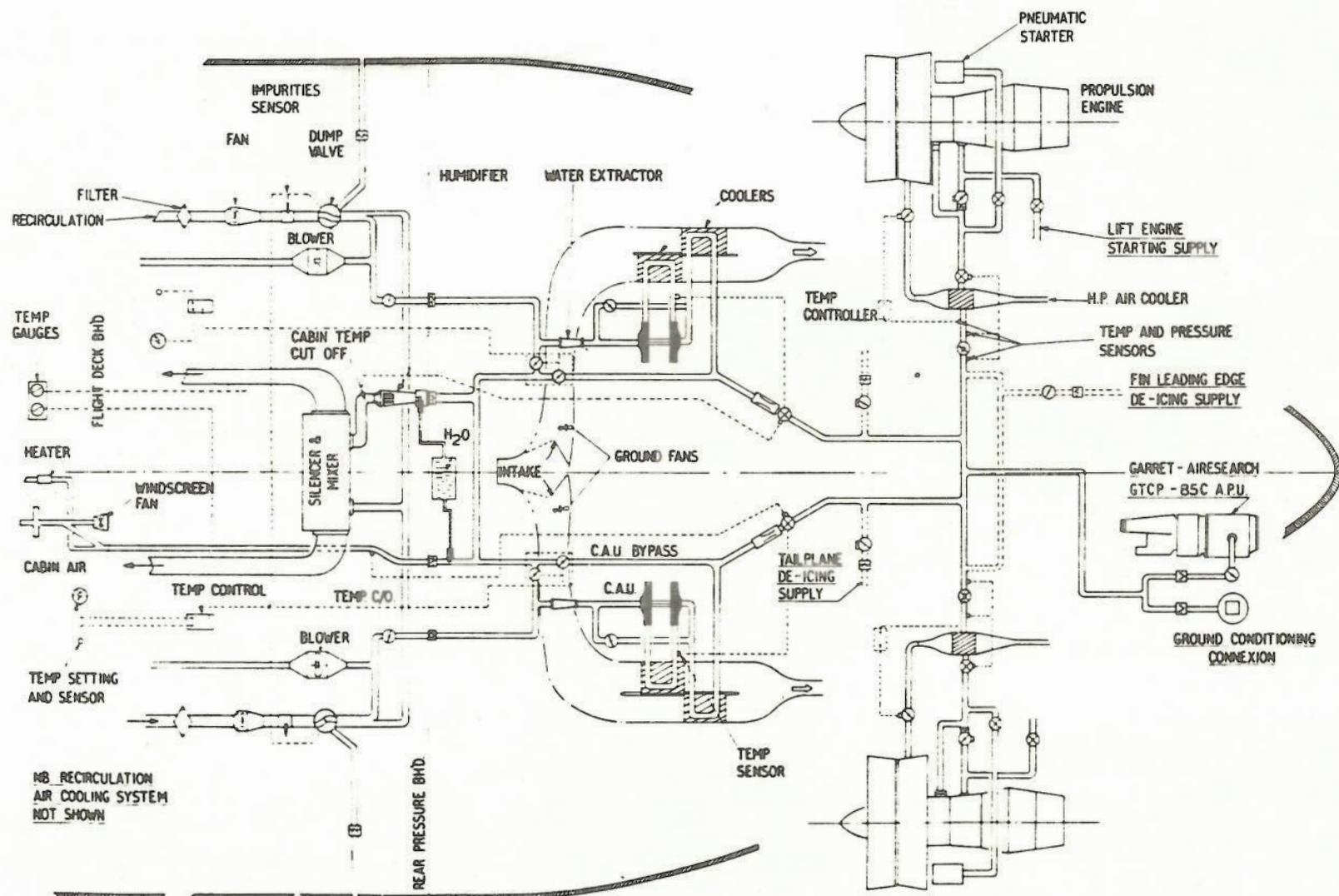

FIG. 15. FUEL SYSTEM



- | | | | |
|--------|-------------------|---|-----------------------|
| ===== | SUPPLY DUCTS | ⊗ | ENGINE STARTING VALVE |
| ⊞----- | NON-RETURN VALVES | ⊙ | PRESSURE RELIEF VALVE |
| ⊙----- | BUTTERFLY VALVES | | |
| ⊗----- | SHUT OFF VALVES | | |
| ----- | ELECTRICAL SIGNAL | | |

FIG. 16. AIR CONDITIONING SYSTEM