

Accepted Manuscript

Water Research, Volume 43, Issue 7, April 2009, Pages 1993-2001

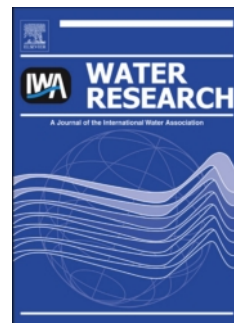

Title: Continuous-flow laboratory simulation of stream water quality changes downstream of an untreated waste water discharge

Authors: C.J. Finnegan, R.A. van Egmond, O.R. Price, M.J. Whelan

PII: S0043-1354(09)00084-0

DOI: [10.1016/j.watres.2009.01.031](https://doi.org/10.1016/j.watres.2009.01.031)

Reference: WR 7280

To appear in: *Water Research*

Received Date: 17 September 2008

Revised Date: 29 January 2009

Accepted Date: 30 January 2009

Please cite this article as: Finnegan, C.J., van Egmond, R.A., Price, O.R., Whelan, M.J. Continuous-flow laboratory simulation of stream water quality changes downstream of an untreated waste water discharge, *Water Research* (2009), doi: [10.1016/j.watres.2009.01.031](https://doi.org/10.1016/j.watres.2009.01.031)

This is a PDF file of an unedited manuscript that has been accepted for publication. As a service to our customers we are providing this early version of the manuscript. The manuscript will undergo copyediting, typesetting, and review of the resulting proof before it is published in its final form. Please note that during the production process errors may be discovered which could affect the content, and all legal disclaimers that apply to the journal pertain.

1
2
3 **Continuous-flow laboratory simulation of stream**
4 **water quality changes downstream of an untreated**
5 **waste water discharge**
6
7

8 C.J. Finnegan¹, R.A. van Egmond¹ O.R. Price¹ and M.J. Whelan^{2*}
9

10
11 ¹Safety and Environmental Assurance Centre, Unilever Colworth Laboratory,
12 Sharnbrook, Bedfordshire, UK, MK44 1LQ

13 ²Department of Natural Resources, School of Applied Sciences, Cranfield University,
14 College Road, Cranfield, Bedfordshire, UK, MK43 0AL
15

16
17
18
19 ** Author for correspondence:*

20
21 **Tel:** +44-1234-752975

22 **Email:** m.j.whelan@cranfield.ac.uk
23

24 **SHORT TITLE:** Simulation of chemical fate under direct discharge

1 ABSTRACT

2 In regions of the world with poor provision of waste water treatment, raw sewage is
3 often discharged directly into surface waters. This paper describes an experimental
4 evaluation of the fate of two organic chemicals under these conditions using an
5 artificial channel cascade fed with a mix of settled sewage and river water at its
6 upstream end and operated under continuous steady-state conditions. The
7 experiments underpin an environmental risk assessment methodology based on the
8 idea of an “impact zone” (IZ) - the zone downstream of waste water emission in
9 which water quality is severely impaired by high concentrations of unionised
10 ammonia, nitrite and biochemical oxygen demand (BOD). Radiolabelled dodecane-6-
11 benzene sulphonate (DOBS) and aniline hydrochloride were used as the model
12 chemical and reference compound respectively. Rapid changes in ^{14}C counts were
13 observed with flow-time for both these materials. These changes were most likely to
14 be due to complete mineralisation. A dissipation half-life of approximately 7.1 h was
15 observed for the ^{14}C label with DOBS. The end of the IZ was defined as the point at
16 which the concentration of both unionised ammonia and nitrite fell below their
17 respective predicted no effect concentrations for salmonids. At these points in the
18 cascade, approximately 83 and 90 percent of the initial concentration of ^{14}C had been
19 removed from the water column, respectively. A simple model of mineral nitrogen
20 transformations based on Michaelis-Menten kinetics was fitted to observed
21 concentrations of NH_4 , NO_2 and NO_3 . The cascade is intended to provide a
22 confirmatory methodology for assessing the ecological risks of chemicals under direct
23 discharge conditions.

24 **Key words:** Direct discharge, LAS, degradation, laboratory simulation study,
25 ammonia, nitrite, river

1 INTRODUCTION

2

3 In many parts of the world, particularly in developing regions such as Asia, South
4 America and Africa, untreated waste water is routinely emitted directly into surface
5 water bodies (e.g. Whelan *et al.*, 1999; Eichhorn *et al.*, 2001; Eichhorn *et al.*, 2002;
6 McAvoy *et al.*, 2003; Whelan *et al.*, 2007). This scenario is typically associated with
7 high levels of suspended solids, biochemical oxygen demand (BOD), nitrite and
8 unionised ammonia in receiving waters, resulting in significant ecological
9 impairment. This presents a number of difficulties for conventional risk assessments
10 for ‘down-the-drain’ chemicals. Most fundamentally, in the absence of removal by
11 secondary sewage treatment, the predicted environmental concentration (PEC) will
12 often exceed the predicted no-effect concentration (PNEC). However, since the
13 ecosystem in the receiving environment will already be significantly impacted by
14 other constituents present in raw waste water, the significance of this simple
15 assessment for the risks posed by synthetic chemicals is questionable.

16

17 An alternative risk assessment model, based on the “impact zone” (IZ) concept, has
18 been proposed for direct discharge conditions (Limlette III Workshop, 1995; McAvoy
19 *et al.*, 2003). In this model, chemicals are assessed in terms of their potential impact
20 on river recovery (self purification) processes (e.g. microbial respiration and
21 nitrification) and in terms of their predicted concentration at the end of an “impact
22 zone”, within which the ecosystem is impacted by pollutants such as unionised
23 ammonia, nitrite and BOD and beyond which, it is not. In the work presented here we
24 only consider the latter assessment: i.e. the concentration of a synthetic organic
25 pollutant at the end of the IZ. For a given scenario (river flow and pollutant loading),

1 the length of the IZ is defined, independently of the chemicals under consideration, as
2 the point at which the concentration of unionised ammonia or nitrite decreases below
3 the respective (nitrite or ammonia) predicted no effect concentration (PNEC) or the
4 point at which dissolved oxygen (DO) concentrations increase above a given
5 threshold. When assessing the impact of a synthetic organic chemical discharged in
6 waste water, the change in chemical concentration within the IZ is estimated and the
7 concentration estimated at the end of the IZ is compared with the chemical PNEC, as
8 it would be in a conventional ecological risk assessment. Note that the length of the
9 IZ is defined only in terms of the behaviour of nitrite, ammonia or dissolved oxygen.
10 For a given scenario it will be the same for all organic chemicals. The extent of
11 organic chemical transformation and loss within the IZ is needed in order to estimate
12 the concentration of the chemical at the end of the IZ. This has been estimated in
13 field monitoring studies using the anionic surfactant, linear alkylbenzene sulphonate
14 (LAS) as a model substance (McAvoy *et al.*, 2003; Whelan *et al.*, 2007). However,
15 such studies are often difficult and expensive to conduct and it is not feasible to assess
16 the behaviour of new chemicals using these methodologies. A laboratory-based
17 simulation system is, therefore, required which will enable the realistic behaviour and
18 associated ecological risks of a range of different chemicals to be evaluated under
19 direct discharge conditions. *In vitro* batch tests, such as those described by Peng *et al.*
20 (2000), undoubtedly have some screening-level value but they are unlikely to generate
21 rate constants which are comparable with those observed in the field. In addition,
22 many batch studies (e.g. Peng *et al.*, 2000) have not compared the rate of loss of the
23 test chemical against the dynamics of mineral nitrogen which controls the length of
24 the IZ.

25

1 In this paper, we describe a laboratory simulation study using a continuous flow river
2 model with attached biomass, under direct discharge conditions with a single point
3 source at the upstream end. The experimental system used is loosely based on
4 apparatus described by Boeije *et al.*, 2000 and in ISO 14592 (2002). Note that both
5 the system described in the ISO 14592 (part 2) guidelines and the system described by
6 Boeije *et al.* (2000) have, thus far, only been applied to relatively clean systems (i.e.
7 without significant fraction of raw waste water). Although an assessment of the
8 inhibitory effect of the substance of interest on key ecosystem functions, such as
9 microbial respiration or nitrification, is integral to the IZ risk assessment approach, we
10 concentrate here on assessing the rate of loss of the test substances compared with the
11 rate of loss of ammonia and nitrite. In order to allow a comparison with field
12 observations (McAvoy *et al.*, 2003; Whelan *et al.*, 2007), a single LAS isomer:
13 dodecane-6-benzene sulphonate (commercial LAS properties: dimensionless Henry's
14 law constant = 7.66×10^{-10} ; calculated $\log K_{OW} = 3.32$: HERA, 2007) was selected as
15 the model chemical. LAS is readily biodegradable under aerobic conditions but is not
16 degraded anaerobically (HERA, 2007). In addition, aniline hydrochloride
17 (dimensionless Henry's law constant = 7.76×10^{-5} ; $\log K_{OW} = 0.9$: USEPA, 1994) was
18 employed as a reference compound. Although aniline is not expected to be found in
19 waste water at high concentrations it is commonly used as a reference compound in
20 laboratory biodegradation studies because it is known to degrade rapidly (e.g. Nyholm
21 and Kristensen, 1992; Battersby, 1997; Toräng *et al.*, 2002; ISO, 2001).

22

23 Several field studies have reported in-stream removal rates for LAS in rivers (e.g.
24 Whelan *et al.*, 1999; Fox *et al.*, 2000; McAvoy *et al.*, 2003; Whelan *et al.*, 2007),
25 wetlands (Inaba *et al.*, 1988) and estuaries (Amano *et al.*, 1991). Short half-life

1 values of typically less than three hours have been reported for shallow rivers and
2 streams (e.g. Takada *et al.*, 1994; Fox *et al.*, 2000; McAvoy *et al.*, 2003). Typically,
3 the water in such systems has a greater contact with the stream bed and bank surfaces,
4 and with associated microbial communities (attached biofilms). Boeije *et al.* (2000)
5 observed that a fixed biofilm was critical for significant removal of LAS and
6 suggested that rates of biodegradation are likely to be highest in shallow rivers with a
7 high surface area to volume ratio. Indeed, much longer surface water half-lives for
8 LAS have been reported for deeper rivers in temperate zones (e.g. 15 h: Whelan *et al.*,
9 1999) and in the tropics (7 h: Whelan *et al.*, 2007).

10

11 **MATERIALS AND METHODS**

12

13 Artificial river system

14 The test system consisted of a cascade containing five shallow rectangular channels
15 made from unplasticized polyvinyl chloride (1.8 m in length, 0.08 m in width)
16 constructed to form an aquatic “staircase” (Figure 1). The volume of water in each
17 channel was $2 \text{ L} \pm 0.2 \text{ L}$ and a water depth of 0.02 – 0.03 m was maintained. The
18 bottom of each channel was covered with glass beads (5 mm diameter) to act as an
19 artificial substrate to enhance the development of a fixed-film biomass (after Boeije *et*
20 *al.*, 2000). The average mass of each bead was 0.17 g. A total bead mass of 724 g
21 was added to each channel with an approximate total surface area of 3345 cm².

22

23 The channels were separated by a vertical distance of 0.18 m and were connected via
24 tubing linking the downstream end of one channel with the upstream end of the next
25 in the cascade. The depth of the outlet at the downstream end of each channel was

1 adjusted so as to maintain a water depth of about 0.01 m above the glass beads. The
2 system was operated in a temperature controlled environment (20°C) under controlled
3 illumination with 8 h of light per day (measured at 1800 lux). The average water
4 temperature was $19.7 \pm 0.2^\circ\text{C}$. The flow rate was maintained via a peristaltic pump at
5 0.42 L h^{-1} (7 mL min^{-1}). A steady-state hydraulic retention time (HRT) of 26 h was
6 measured using a NaCl tracer test prior to any dosing with waste water, but including
7 the glass beads. Flow was recorded at regular intervals during the study. The storage
8 vessel for the test medium was connected to the first channel of the cascade. The test
9 medium consisted of one part settled sewage (i.e. post primary settler at the STP) :
10 two parts river water, reflecting the common situation of direct discharge of sewage
11 into river water. Both settled sewage and river water were collected regularly (every
12 other day) from a local sewage treatment plant (Broadholme STP, Northamptonshire,
13 UK) and river (River Great Ouse at Felmersham Bridge, Bedfordshire, UK),
14 respectively. Although the use of these media can potentially introduce variability
15 into the system, they have the advantage of more closely representing the true nature
16 of waste water and receiving surface water quality. To help reduce variability in the
17 test medium, excess medium on any day was mixed with freshly prepared medium on
18 the next. Approximately 10 L of test medium were freshly prepared daily and mixed
19 with surplus medium (ca. 5 L) from the previous day. In other words, 10 L was used
20 over one HRT and 5 L was carried forward to the following day. No aeration was
21 provided to the system, apart from across the air-water interface.

22

23 FIG 1 ABOUT HERE

24

25 Acclimation of the test system

1 Prior to the introduction of the radiolabelled compounds, it was necessary to ensure
2 that the cascade had reached a steady-state in terms of major water quality
3 determinands (pH, DO, temperature, ammonium(NH_4^+), nitrite (NO_2^-), nitrate (NO_3^-)
4 and COD) and had developed a biofilm. From the start of the experiment, samples
5 were taken from the inlet and outlet of each channel (i.e. at 0, 1.8, 3.6, 5.4, 7.2, 9.0 m)
6 and analysed for NH_4^+ , NO_2^- , NO_3^- and COD three times a week. All water quality
7 analyses were performed using cuvette test methods on a Xion 500 Spectrophotometer
8 (Hach-Lange GmbH, Dusseldorf, Germany). In addition, the channels were
9 frequently monitored for temperature, pH and DO concentration. The water quality
10 parameters and DO concentration were used to determine when the system reached
11 steady-state conditions (i.e. after sufficient microbial biomass, including nitrifiers, had
12 developed), at which point the radio-labelled materials were introduced to the feed.

13

14 Typically native LAS concentrations in waste water can range between 1 and 15 mg
15 L^{-1} (Henze *et al.*, 2002). The average concentration of total native LAS in the test
16 medium (measured by liquid chromatography electrospray ionisation mass
17 spectrometry) prior to the addition of radiolabelled materials was $1.28 \pm 0.15 \text{ mg L}^{-1}$.

18

19 *Model chemical and reference compound*

20 The behaviour of the following organic compounds was investigated: (1) Reference
21 compound: [^{14}C] Aniline Hydrochloride supplied by Sigma-Aldrich, USA and (2)
22 Model chemical: Radio-labelled C_{12} LAS: ^{14}C sodium dodecane-6-benzene
23 sulphonate (Phenyl- ^{14}C 6-DOBS), supplied by Scynexis, Ongar, UK.

24

1 The radiochemical purities of the [U-¹⁴C]-aniline and Phenyl-¹⁴C 6-DOBS were
2 determined using Spectra Physics Radio HPLC (Prodigy C18 column, 250 x 4.6 mm,
3 Phenomenex). The radiochemical purities of [U-¹⁴C]-aniline and Phenyl-¹⁴C 6-
4 DOBS were both 99 percent, with specific activities of 77 and 19 mCi mmol⁻¹,
5 respectively.

6
7 Stock solution of Phenyl-¹⁴C 6-DOBS was prepared by dissolving 7.4 mg of Phenyl
8 -¹⁴C 6-DOBS in 2 mL of methanol (HPLC grade) to give a concentration of 3.7 mg
9 mL⁻¹. Triplicate aliquots (50 µL) of the concentrated stock were made up to 10 mL
10 with methanol to give three replicate solutions. Triplicate aliquots (100 µL) of each
11 solution were mixed with Starscint (Perkin Elmer) for liquid scintillation counting. A
12 working stock solution was prepared so that a count of approximately 5000 DPM mL⁻¹
13 ¹, for both the reference chemical and the test compound, was obtained after dilution
14 in the cascade system. The target concentration for Phenyl-¹⁴C 6-DOBS was 30 µg
15 L⁻¹.

16
17 Each radio-labelled compound was added continuously to the cascade as a secondary
18 substrate after the establishment of steady-state conditions. The ¹⁴C stock solution
19 was mixed with the test medium (settled sewage / river water) from a syringe-
20 controlled dosing unit in a stirred biometer flask (100 mL) prior to feeding the top of
21 channel 1. The flask was changed regularly to prevent any biofilm development and
22 degradation prior to injection into the cascade. The reference compound (¹⁴C-aniline)
23 was added to the influent on days 38-47 and the Phenyl-¹⁴C 6-DOBS was added on
24 days 95-104. Note that the system was clear of any radiolabelled aniline at this stage.

25

1 For both radiolabelled compounds, the analysis of samples collected at different points
2 in the cascade represent total ^{14}C remaining, after sample acidification with H_2SO_4
3 (2 M) to expel dissolved CO_2 . This does not differentiate between degradation
4 products and parent molecules. Reductions in the concentration of ^{14}C , therefore,
5 represent a net loss from the water column which is most likely due to complete
6 mineralisation (conversion to CO_2) rather than primary degradation of parent
7 molecules, although some loss from the water column by sorption to the substrate and
8 the channel walls cannot be discounted.

9

10 **MODELLING**

11

12 During the experimental phase, it was assumed that the system behaved as a steady-
13 state plug-flow reactor with complete vertical and cross channel mixing and with
14 transport occurring exclusively by turbulent advection.

15

16 Organic Compounds

17 Single (pseudo) first order kinetics (SFO) have been successfully used to describe the
18 degradation of a number of organic compounds, including LAS, in river systems (e.g.
19 Fox *et al.*, 2000; McAvoy *et al.*, 2003; Whelan *et al.*, 2007) and in artificial channels
20 (e.g. Boeije *et al.*, 2000). The SFO model can be written

21

$$22 \quad \frac{dC}{dt} = -k.C \quad (1)$$

23

1 where C is the concentration of substance remaining (mg L^{-1}), t is time (h) and k is a
2 biodegradation rate constant (h^{-1}) which is obtained via least squares fitting of the
3 following solution to Equation (1):

4

$$5 \quad C = C_0 \cdot \exp(-k \cdot \tau) \quad (2)$$

6

7 where C_0 is the concentration at the start of the cascade and τ is the mean solute travel
8 time (h), assumed to be the HRT derived from tracer tests with NaCl. Equation (1)
9 will only apply where DO is not limiting to the degradation rate. The degradation
10 half-life, $T_{1/2}$ (h) is thus:

11

$$12 \quad T_{1/2} = \frac{\ln(2)}{k} \quad (3)$$

13

14 Mineral Nitrogen

15 Mineral nitrogen dynamics in the system were simulated using a simple three pool
16 model system comprising of ammonium N, nitrite N and nitrate N. Although
17 nitrification has frequently been described using first order kinetics (*e.g.* Chapra,
18 1997; Martin and Reddy, 1997; McAvoy *et al.*, 2003), Michaelis-Menten (MM)
19 kinetics have also been used (*e.g.* Charley *et al.*, 1980). The use of MM has the
20 advantage of allowing for the representation of the transition between zero order
21 kinetics at high substrate concentration and first order kinetics at lower concentrations
22 and was, therefore, adopted here. The following rate equations were applied:

23

24

$$\frac{dC_{NH_4}}{dt} = -\frac{v_1 \cdot C_{NH_4}}{k_1 + C_{NH_4}} \quad (4)$$

$$\frac{dC_{NO_2}}{dt} = \frac{v_1 \cdot C_{NH_4}}{k_1 + C_{NH_4}} - \frac{v_2 \cdot C_{NO_2}}{k_2 + C_{NO_2}} \quad (5)$$

$$\frac{dC_{NO_3}}{dt} = \frac{v_2 \cdot C_{NO_2}}{k_2 + C_{NO_2}} - \frac{v_3 \cdot C_{NO_3}}{k_3 + C_{NO_3}} \quad (6)$$

where C_{NH_4} , C_{NO_2} and C_{NO_3} are the concentrations of ammonium N, nitrite N and nitrate N, respectively (mg N L^{-1}), v_1 , v_2 and v_3 are maximum rates ($\text{mg N L}^{-1} \text{ h}^{-1}$) and k_1 , k_2 and k_3 are half-saturation constants (mg N L^{-1}) for, respectively: (1) nitrification (ammonia to nitrite); (2) nitrification (nitrite to nitrate) and (3) nitrate loss (due to uptake by the microbial biomass or denitrification). Note that ammonium N will be formed in aqueous systems via the mineralisation of organic nitrogen and from the hydrolysis of urea. Urea hydrolysis is likely to be the main source for ammonium, but most urea will probably have hydrolysed before dosing to the cascade (Metcalf and Eddy, 1979). However, since there was no direct evidence of the formation of ammonium in the test system and since organic N and urea concentrations were not measured, an ammonium source term is not included.

Impact zone

The definition of the impact zone in the experiments was based on water quality criteria for concentrations of unionised ammonia and nitrite for toxicity to freshwater fish. A toxicity threshold (PNEC) of $25 \mu\text{g L}^{-1}$ has been reported by Alabaster and Lloyd (1980) for the protection of freshwater fisheries based on toxicity of unionised ammonia to salmonids (EC Freshwater Fish Directive 78/659/EEC). The fraction of total ammoniacal nitrogen which is unionised is highly pH-dependent. The

1 concentration of unionised ammonia (C_{NH3}) was calculated using the following
2 equation:

$$3 \quad C_{NH3} = \frac{C_{NH4}}{\alpha} \left(\frac{1}{1 + 10^{(pKa - pH)}} \right) \quad (7)$$

4
5
6 where α is the fraction of N in NH_4^+ (0.78) and where pKa is the temperature-
7 dependent dissociation constant which was set at 9.42 (for a system temperature of 20
8 °C).

9
10 Nitrite toxicity is strongly dependant on the chloride concentration of surface waters,
11 which tends to reduce toxicity (Eddy and Williams, 1994). There are existing EU
12 standards for nitrite in surface waters under the Freshwater Fish Directive
13 (78/659/EEC). The guideline PNEC value given under this Directive for salmonid
14 waters is $10 \mu\text{g L}^{-1}$ (i.e. $\sim 3 \mu\text{g N L}^{-1}$).

15 16 **RESULTS AND DISCUSSION**

17 18 Test medium quality

19 The quality of the test medium was monitored over the course of the study. Overall
20 results are shown in Table 1. In general, the variability was very low ($CV < \sim 10\%$)
21 and there was no systematic temporal pattern to the variability of any of the measured
22 variables.

23
24 TABLE 1 ABOUT HERE

1
2 The test medium was also analysed for native linear alkyl benzene sulphonate (LAS)
3 already present in the waste water source using liquid chromatography / mass
4 spectrometry (LC/MS) following solid phase extraction on six separate occasions over
5 the course of the experiment. Details of the method used can be found in Whelan *et*
6 *al.* (2007). The method showed good mean recoveries of total LAS (99.1 ± 2.5 %:
7 mean \pm standard deviation (SD), n=6), from spiked samples at 5 mg L^{-1} . Total LAS
8 concentrations in the influent media ranged between 1.06 and 1.46 mg L^{-1} with a
9 mean of $1.28 \pm 0.15 \text{ mg L}^{-1}$. This indicates that the microbial biomass associated with
10 the input medium, and hence the resident microbial community in the channel system,
11 is likely to be well adapted to LAS and suggests that significant lag times (Shimp *et*
12 *al.* 1989) should not be expected. The low variability in the LAS concentrations
13 measured reflects (1) the fact that batches were collected from the STP at the same
14 time of day each time; (2) the fact that the liquid collected was “settled” sewage – i.e.
15 post primary settler and, therefore, already mixed and (3) the fact that the STP from
16 which the sewage was collected is fairly large, integrating some of the variability
17 which might be expected in smaller plants.

18

19 Dissolved Oxygen and COD

20 Observed DO measurements in the cascade are shown in Figure 2 for some selected
21 days through the study period. These data show the development of a DO “sag” (see
22 Adrian *et al.*, 2004) with relatively low concentrations (*ca* 2 mg L^{-1}) at the upstream
23 end of channel 1 and a gradual increase in DO concentrations further downstream.
24 Based on our observations of LAS degradation under direct discharge conditions in
25 Laos (Whelan *et al.*, 2007), the lowest DO concentrations observed in the cascade are

1 probably not low enough to inhibit LAS degradation – which is known to be a strictly
2 aerobic process. Stepped increases in DO concentration are evident at the transition
3 points between channel units. This is an artefact of the experimental system, which
4 does not reflect expected processes in real rivers, with the exception of riffles and
5 cataracts. The extent to which these discontinuities affect the behaviour of the
6 nitrogen species used to define the IZ or that of the model chemical and reference
7 compound is not known. However, corresponding step changes in the concentration
8 of other determinands are not apparent, suggesting that the “steps” do not have a
9 major impact – probably because oxygen was not limiting to degradation or
10 nitrification.. The DO profiles on different days suggest that it took several days for
11 steady-state conditions to develop. All measurements from about day 29 onwards
12 show a very similar pattern, as illustrated for days 29 and 50.

13

14 FIG 2 ABOUT HERE

15

16 Changes in COD concentrations with distance downstream are shown in Figure 3 for
17 different days after the start of the experiment. There was a gradual increase in the
18 rate of COD reduction in the system during the first few days after the start of
19 operation as the microbial biomass developed within the channels, followed by a
20 period of quasi-steady-state. The rate of reduction in COD with distance was greatest
21 in the first channel. This suggests that the conditions in channel 1 were more
22 favourable to degradation – probably as a result of higher microbial biomass. For the
23 overall cascade, first order kinetics were generally not applicable to describe COD.
24 However, reasonable fits were obtained with a first order equation using data from
25 channels 2-5 only (i.e. omitting data from channel 1).

1

2 FIG 3 ABOUT HERE

3

4 Reference Compound

5 The degradation pattern of radiolabelled reference material (^{14}C aniline
6 hydrochloride) is shown in Figure 4. As with COD, the data suggest that the aniline is
7 degraded very rapidly in the first channel of the cascade (i.e. after a travel time of 5.24
8 h), confirming the presence of a viable biofilm. However, degradation in subsequent
9 channels was considerably slower. Overall the data could not be described well using
10 first order kinetics, fitted using a least squares optimisation, with travel time estimated
11 using an axial velocity of 0.34 m h^{-1} (see Figure 4 solid line). However, an acceptable
12 fit was obtained by restricting the model fit to data from channels 2 to 5 only (i.e.
13 optimising Equation (2) with C_0 set to the observed concentration at the start of
14 channel 2). This is justified on the basis of clear visual evidence of a higher settled
15 solids content in the first channel during the course of the experiments and the
16 presence of a discontinuity at the downstream end as the flow is transferred to channel
17 2 via the connecting pipe. This suggests that aniline behaviour in the cascade can be
18 described using first order kinetics provided that the nature of the fixed film biomass
19 is approximately constant. The best-fit half-life of aniline in channels 2 to 5 was 21.7
20 h. The apparent half-life in the first channel derived from a first order best-fit to the
21 first three data points was 3.02 h.

22

23 FIG 4 ABOUT HERE

24

25 Model Chemical

1 The observed pattern of ^{14}C reduction in the cascade after dosing with ^{14}C Phenyl -6-
2 DOBS is shown in Figure 5. Concentrations are given in total ^{14}C remaining (i.e.
3 including metabolites) and are, therefore, indicative of ultimate degradation (i.e.
4 complete mineralisation). This is an important distinction between the results of this
5 study and many field studies which often employ specific analysis (e.g. Fox *et al.*,
6 2000; McAvoy *et al.*, 2003; Whelan *et al.*, 2007) to measure primary degradation of
7 the parent molecules.

8
9 The first order kinetic model best-fit is shown as a thick solid line in Figure 5. It is
10 clear that the overall pattern of average ^{14}C reduction in the cascade does not follow
11 first order kinetics. As with COD and ^{14}C aniline hydrochloride the rate of loss in
12 channel 1 (i.e. upto a travel time of 5.24 h) is more rapid than in subsequent channels.
13 In addition, there is considerable variability in the measured data. A best-fit second
14 order kinetic curve for the average data is also shown in Figure 5 (dashed line), which
15 clearly provides a superior description of the observed pattern. Nevertheless, it is
16 more likely that the observed pattern of ^{14}C loss is due to discontinuities in settled
17 solids and associated biofilm growth between channels in the cascade rather than due
18 to the operation of non-first order kinetics. First order kinetics described the data in
19 channels 2-5 reasonably well (thin solid line in Figure 5), yielding a best-fit half-life
20 of 7.1 h. This is similar to the apparent half-life observed for primary degradation of
21 LAS in Lao PDR by Whelan *et al.* (2007), although the primary degradation half-life
22 of LAS in the cascade system is likely to be much less than the ^{14}C half-life reported
23 above. The loss of metabolites (predominantly sulphophenylcarboxylates, SPCs) may
24 limit the overall loss rate if the rate constant for these substances is slower than for the
25 parent material. SPCs, which are less toxic than LAS, are formed by the

1 biodegradation of LAS mainly by ω -oxidation of the alkyl chain followed by β -
2 oxidation which shortens the chain lengths by two carbon atoms respectively to give a
3 wide range of homologues and isomers (Swisher, 1987; Gonzalez-Mazo *et al.*, 1997;
4 Schleheck *et al.*, 2004). The rate of biodegradation of SPCs is generally believed to
5 be significantly slower than for LAS (*e.g.* León, *et al.*, 2004). A shorter half-life for
6 LAS would be expected in the cascade system due to low water depth and a high
7 degree of contact between the water column and solid surfaces in the bed (Boeije *et*
8 *al.*, 2000).

9
10 FIG 5 ABOUT HERE

11
12 LAS is non-volatile and ^{14}C removal was assumed to be completely due to
13 biodegradation rather than sorption to solids or sedimentation. Since the glass beads
14 were not extracted for ^{14}C , the significance of adsorption is unknown. Sorption to the
15 unplasticized polyvinyl chloride channel walls is also possible (*cf* Antizar-Ladislao
16 and Galil, 2006) but is likely to be minimised in our system by relatively rapid flow
17 through and a low contact time. Confirmation of the potential for rapid
18 biodegradation was obtained by using five glass beads with attached biofilm (taken
19 from the first channel after the radio labelled analysis had been completed) as an
20 inoculum source in a respirometric test with LAS in a mineral salt medium, using the
21 OxiTop system (WTW, Weilheim, Germany). A control vessel containing beads
22 from the cascade but no added LAS was operated in parallel to measure the
23 background respiration rate. LAS was added to the test vessels at a concentration of
24 75 mg L^{-1} Theoretical Oxygen Demand. After 5 days, oxygen consumption in the test

1 vessels was $> 57 \text{ mg L}^{-1}$ higher than in the control vessels, confirming that
2 biodegradation was a likely mechanism of removal (Finnegan, 2007).

3

4 Mineral Nitrogen Dynamics

5 The typical pattern of mineral nitrogen dynamics in the cascade is illustrated in Figure

6 6. Measured data from days 22-104 were used, when the system appeared to be
7 operating under steady-state conditions. The data suggest a relatively rapid
8 conversion of NH_4 to NO_2 and subsequently to NO_3 and a progressive build up of
9 NO_3 concentrations to about $13 (\pm 1.3) \text{ mg N L}^{-1}$. Initial nitrite concentrations were
10 about $2.3 (\pm 0.76) \text{ mg N L}^{-1}$ and decreased progressively with residence time to about
11 $0.03 (\pm 0.06) \text{ mg N L}^{-1}$ at the end of the final channel.

12

13 It should be noted that before day 22, a gradual adaptation was observed in the pattern
14 of mineral N concentrations in the system with an increase in $\text{NO}_2\text{-N}$ concentrations
15 observed through the cascade up to day 15, followed by a gradual levelling off and
16 eventually a systematic decrease in $\text{NO}_2\text{-N}$ concentrations after day 31 (data not
17 shown). This reflects the slow development of a competent community of nitrifiers in
18 the system.

19

20 FIG 6 ABOUT HERE

21

22 The N model (Equations 4-6) was solved numerically (Euler's method with a time
23 step of 0.1 h). The parameters k_1 , k_2 , k_3 , v_1 , v_2 and v_3 were optimised using an iterative
24 least squares fitting procedure against the observed data on mineral N in the cascade
25 to yield the following values: 0.34 mg N L^{-1} , 0.26 mg N L^{-1} , 0 mg N L^{-1} , 0.638 mg N

1 $L^{-1} h^{-1}$, 0.8483 and 0.047 $mg N L^{-1} h^{-1}$ respectively. Half-saturation constants for both
2 nitrification steps (k_1 and k_2) are low compared with NH_4-N and NO_2-N
3 concentrations in the first half of the cascade implying that kinetics are effectively
4 zero-order over much of the channel length. This is in accordance with values for the
5 half-saturation constant of nitrification reported by other workers (e.g. 0.59 $mg N L^{-1}$
6 in activated sludge: Charley *et al.*, 1980). The low value for v_3 and the fact that the
7 optimal value for k_3 is zero (i.e. zero order kinetics apply to nitrate losses) suggest that
8 the loss rate for NO_3 is low. In fact, setting the value of v_3 to zero (i.e. assuming no
9 losses for NO_3) results in an only marginally poorer fit. The data also imply that there
10 was little significant ammonification in the system over the typical time-of-travel of
11 the cascade. Although the concept of a half-life is not strictly applicable to Michaelis-
12 Menten kinetics, the time taken for initial concentrations of NH_4-N and NO_2-N to
13 reduce by half are approximately 7.8 and 9 h respectively. Which are both higher
14 than the best-fit half-life for the ultimate degradation of ^{14}C Phenyl -6-DOBS. This is
15 in agreement with reports from other workers (e.g. Fox *et al.*, 2000; McAvoy *et al.*,
16 2003; Whelan *et al.*, 2007) that primary degradation of LAS usually proceeds at rates
17 which are significantly faster than ammonium oxidation.

18 Much of the literature on nitrification in aqueous systems suggests that, like
19 biodegradation (e.g. Boeije *et al.*, 2000), it is performed predominantly by micro-
20 organisms in fixed biofilms rather than by suspended colonies (e.g. Moreau *et al.*,
21 1994). Note that it is interesting that the discontinuities in the concentration data
22 observed between the first and second channels for COD, ^{14}C aniline hydrochloride
23 and ^{14}C Phenyl 6 DOBS are not apparent in the mineral nitrogen data. This could be
24 due to the fact that nitrification appears to operate with zero order kinetics in the first

1 half of the cascade. At high concentrations, under zero order kinetics, the rate is
2 limited to a maximum rate.

3

4 Implications for Risk Assessment

5 In our experimental system, the end of the IZ was assumed to be the point at which
6 the concentration of unionised ammonia fell below the PNEC for salmonids. The
7 PNEC for salmonids was arbitrarily chosen because fish are usually desirable
8 animals to protect. However, toxic thresholds for other species may be more
9 appropriate. Note that observed nitrite concentrations in the cascade were always
10 above the nitrite PNEC. Under steady-state conditions, the mean modelled unionised
11 ammonia concentration (Equation 7) in the cascade fell below the unionised ammonia
12 PNEC ($25 \mu\text{g L}^{-1}$) at a travel time of approximately 16 h and the mean modelled
13 nitrite concentration fell below the nitrite PNEC ($\sim 3 \mu\text{g N L}^{-1}$) at a travel time of
14 approximately 19 h. Thus the most conservative estimation for the end of the IZ is 16
15 h. At these points (16 and 19 h), the concentration of ^{14}C (after acidification) was
16 observed to be about 17 % and 9.7 % of the concentration at the start (suggesting 83%
17 and 90.3 % mineralisation), respectively. Based on an influent native LAS
18 concentration of 1.28 mg L^{-1} , this implies that the total non-mineralised concentration
19 (LAS + metabolites) should be approximately 218 and $124 \mu\text{g L}^{-1}$ respectively at these
20 points in the system. These values are less than the LAS PNEC of $245 \mu\text{g L}^{-1}$
21 proposed by Dyer *et al.* (2003) based on a species sensitivity distribution. The use of
22 ^{14}C -labelled material gives an indication of complete mineralisation, rather than just
23 loss of the parent compound, so it is likely that the parent LAS remaining will be
24 much less than these values. In a field study conducted on a waste-water-impacted
25 river channel in Laos, Whelan *et al.* (2007) observed that the total SPC : total LAS

1 ratios near the end of the impact zone were as high as 200 percent. Such a ratio
2 would, speculatively, put the total LAS end-of-IZ concentration at about $72 \mu\text{g L}^{-1}$
3 and $41 \mu\text{g L}^{-1}$ respectively at 16 and 19 h. However, in the absence of measured data
4 on levels of native LAS in the cascade, such estimates should be viewed with caution.

5
6 It is important to note that both pollutant loading and flow regime are likely to vary in
7 field situations. Although this variability may influence the extent of dilution
8 provided by receiving water bodies, solute travel times and the length of the IZ, our
9 experience in Laos (Whelan *et al.*, 2007) suggests that diurnal variability in LAS and
10 ammonia concentrations under steady flow conditions are relatively constant in time.
11 In such cases, the steady-state loading and river flow assumptions implicit in the IZ
12 model are justifiable and lend validity to the steady-state laboratory cascade described
13 here. That said, in cases where loading variability is more significant, the fact that the
14 IZ approach is based on relative changes in organic pollutant concentrations compared
15 with inorganic nitrogen concentrations should reduce the temporal and spatial
16 dependency of the risk assessment, provided that loads of organic chemical and
17 inorganic nitrogen change contemporaneously. In the same way, both mineral
18 nitrogen dynamics and organic chemical degradation will be affected similarly by
19 water depth and temperature. Thus, the fact that the laboratory cascade was operated
20 at a lower temperature than that frequently observed in tropical systems and the fact
21 that water depth in the cascade is relatively shallow are not believed to affect the risk
22 assessment outcome significantly.

23

24 CONCLUSIONS

25

1 This paper presents experimental observations of downstream water quality changes
2 in a laboratory-scale continuous-flow channel cascade subjected to direct discharge
3 conditions. The system was able to reproduce expected changes in general water
4 quality resulting from the emission of untreated waste water (e.g. high COD and
5 BOD, associated DO sag, followed by recovery and high unionised ammonia and
6 nitrite concentrations which decrease with distance downstream). When radiolabelled
7 phenyl-6-DOBS and aniline hydrochloride were introduced continuously into the
8 discharge rapid changes in ^{14}C counts were observed with flow-time, representing
9 complete mineralisation. A mineralisation half-life of approximately 7.1 h was
10 observed for ^{14}C Phenyl-6-DOBS (C_{12} LAS).

11
12 A simple model of mineral nitrogen transformations, based on Michaelis-Menten
13 kinetics was fitted to observed concentrations of NH_4 , NO_2 and NO_3 . Approximately
14 83 and 90.3 percent of the initial concentration of ^{14}C Phenyl-6-DOBS were estimated
15 to have been mineralised by the time unionised ammonia and nitrite concentrations
16 fell below their respective PNECs. This is expected to represent a reduction in total
17 native LAS concentration to well below the LAS PNEC and confirms similar
18 observations made in the field under tropical direct discharge conditions reported by
19 McAvoy *et al.* (2003) and Whelan *et al.* (2007).

20
21 The cascade system is intended to provide a confirmatory methodology for assessing
22 the ecological risks of chemicals under direct discharge conditions, without the need
23 for expensive field campaigns. Further work is required both in the field and in the
24 laboratory to ascertain the extent to which the patterns observed for LAS can be
25 generalised to other readily biodegradable and inherently degradable substances.

1

2 **ACKNOWLEDGEMENTS**

3

4 The authors are grateful to Dr Chris Sparham and Sean O'Connor for analytical
5 support; to David Sanders for advice on the radiolabel methodology; to Drs Naheed
6 Rehman and Stuart Marshall for useful discussion and to three anonymous referees
7 for insightful comments and suggestions.

ACCEPTED MANUSCRIPT

1

2 **REFERENCES**

- 3 Adrian, D.D., Roider, E.M. and Sanders, T.G. (2004) Oxygen sag models for
4 multiorder biochemical oxygen demand reactions. *Journal of Environmental*
5 *Engineering-ASCE* 130(7), 784-791.
- 6 Alabaster, J.S. and Lloyd, R. (1980) *Water quality criteria for freshwater fish*
7 Chapter 4 Ammonia pp 85-102, Butterworths.
- 8 Antizar-Ladislao, B. Galil, N.I. (2006) Biodegradation of 2,4,6-trichlorophenol and
9 associated hydraulic conductivity reduction in sand-bed columns.
10 *Chemosphere* 64(3), 339–349.
- 11 A.I.S.E / CESIO (1995) Limelette Workshop. Environmental Risk Assessment of
12 Detergent Chemicals, Nov,1995.
- 13 Amano, K., Fukushima, T. and Nakasugi, O. (1991) Fate of linear
14 alkylbenzenesulfonates in a lake estuary. *Water Science and Technology* 23(1-
15 3), 497-506.
- 16 Battersby, N.S. (1997) The ISO headspace CO₂ biodegradation test. *Chemosphere* 34,
17 1813–1822.
- 18 Boeije, G.M., Schowanek, D.D. and Vanrolleghem, P.A. (2000) Incorporation of
19 biofilm activity in instream biodegradation modeling: A case study for LAS.
20 *Water Research* 34(5), 1479-1486.
- 21 Chapra S.C. (1997) *Water Quality Modeling*, McGraw Hill, New York, 844pp.
- 22 Charley, R.C., Hooper, D.G. and McLee, A.G. (1980) Nitrification kinetics in
23 activated sludge at various temperatures and dissolved oxygen concentrations.
24 *Water Research* 14(10), 1387-1396.

- 1 Dyer, S.D. Peng, C., McAvoy, D.C., Fendinger, N.J., Masscheleyn, P., Castillo, L.V.
2 and Lim, J.M.U. (2003) The influence of untreated wastewater to aquatic
3 communities in the Balatuin River, the Philippines. *Chemosphere* 52(1), 43-
4 53.
- 5 Eddy , F.B. and Williams E.M. (1994). *Freshwater fish and nitrite. In Water Quality*
6 *for Freshwater Fish* (ed G Howells). Volume 6, pp 117-143.
- 7 Eichhorn, P., Flavier, M.E., Paje, M.L. and Knepper, T.P. (2001) Occurrence and fate
8 of linear and branched alkylbenzenesulfonates and their metabolites in surface
9 waters in the Philippines. *Science of the Total Environment* 269(1-3), 75-85.
- 10 Eichhorn, P., Rodrigues, S.V., Baumann, W. and Knepper, T.P. (2002) Incomplete
11 degradation of linear alkylbenzene sulfonate surfactants in Brazilian surface
12 waters and pursuit of their polar metabolites in drinking waters. *Science of the*
13 *Total Environment* 284(1-3), 123-134.
- 14 Finnegan, C. (2007) Development of simulation tests to assess the fate of Unilever
15 ingredients under untreated discharge conditions. Unpublished MPhil Thesis
16 Cranfield University, UK
- 17 Fox, K., Holt, M., Daniel, M., Buckland, H. and Guymer, I. (2000) Removal of linear
18 alkylbenzene sulfonate from a small Yorkshire stream: contribution to
19 GREAT-ER project #7. *Science of the Total Environment* 251, 265-275.
- 20 González-Mazo, E., Honing, M., Barcelo, D. and Gómez-Parra, A. (1997) Monitoring
21 Long-Chain Intermediate Products from the Degradation of Linear
22 Alkylbenzene Sulfonates in the Marine Environment by Solid-Phase
23 Extraction Followed by Liquid Chromatography/Ionspray Mass Spectrometry.
24 *Environmental Science and Technology* 31(2), 504-510.

- 1 Good Laboratory Practice Regulations (1999) Statutory Instrument No. 3106 and
2 OECD Principles on Good Laboratory Practice (as revised in 1997)
3 ENV/MC/CHEM(98)17.
- 4 Henze, M., Harremoës, P., Jansen, J.L.C. and Arvin, E. (2002) *Wastewater Treatment*
5 – *Biological and Chemical Processes*, 3rd Edition, Springer.
- 6 HERA (2007) Linear Alkylbenzene Sulphonate. Human and Environmental Risk
7 Assessment on ingredients of European Household Cleaning Products
8 (<http://www.heraproject.com/>)
- 9 Inaba, K., Iwaski, K. and Yagi, K. (1988) A method for behaviour analysis of
10 synthetic chemicals in the aquatic environment using their adsorption
11 constants - A Study of Linear Alkylbenzenesulfonate in wetland.
12 *Environmental Technology Letters* 9(12), 1387 – 1392.
- 13 ISO 14592 (2002) Water quality — Evaluation of the aerobic biodegradability of
14 organic compounds at low concentrations — Part 1: Shake-flask batch test
15 with surface water or surface water/sediment suspensions Part 2: Continuous
16 flow river model with attached biomass.
- 17 ISO (2001) ISO/FDIS 14592-1: Water quality—Evaluation of the aerobic
18 biodegradability of organic compounds at low concentrations. Part 1: Shake
19 flask batch test with surface water or surface water/sediment suspensions.
20 ISO/TC 147/ SC 5/WG 4. International Organization for Standardization.
- 21 León, V.M., Gómez-Parra, A. and González-Mazo, E. (2004) Biodegradation of
22 Linear Alkylbenzene Sulfonates and their degradation intermediates in
23 seawater. *Environmental Science and Technology* 38(8), 2359-2367.
- 24 Martin J.F. and Reddy K.R. (1997) Interaction and spatial distribution of wetland
25 nitrogen processes. *Ecological Modelling* 105(1), 1-21.

- 1 McAvoy, D.C., Masscheleyn, P., Peng, C., Morrall, S.W., Casilla, A.B, Lim, J.M.U.,
2 Gregorio, E.G. (2003) Risk Assessment approach for untreated waste water
3 using the QUAL2E water quality model. *Chemosphere* 52(1), 55-66.
- 4 Metcalf and Eddy Inc. (1979) *Wastewater Engineering Treatment Disposal Reuse* 2nd
5 Edition, McGraw-Hill, New York
- 6 Moreau, M., Liu, Y., Capdeville, B., Audic, J.M. and Calvez, L. (1994) Kinetic-
7 Behavior of Heterotrophic And Autotrophic Biofilms in Waste-Water
8 Treatment Processes. *Water Science and Technology* 29(10-11), 385-391.
- 9 Nyholm N. and Kristensen P. (1992) Screening methods for assessment of
10 biodegradability of chemicals in seawater— results from a ring test.
11 *Ecotoxicol. Environ. Safe.* 23, 161–172.
- 12 Peng, C-G., Arakai, K., Jung, K. and Namkung, E. (2000) Biodegradation of
13 household chemicals in river water under untreated discharge conditions.
14 *Water Science and Technology* 42(7-8), 377-382.
- 15 Schleheck, D., Knepper, T.P., Fischer, K. and Cook, A.M. (2004) Mineralisation of
16 individual congeners of linear alkylbenzenesulfonate by defined pairs of
17 heterotrophic bacteria. *Applied and Environmental Microbiology* 70(7), 4053-
18 4063.
- 19 Shimp, R.J., Schwab, B.S. and Larson R.J. (1989) Adapation to a quaternary
20 ammonium surfactant by suspended microbial communities in a model stream.
21 *Environmental Toxicology and Chemistry* 8(8), 723-730.
- 22 Swisher, R.D. (1987) *Surfactant Biodegradation* 2nd Edition Marcel Dekker, New
23 York.

- 1 Takada, H., Mutoh, K., Daniel, M., Tomita, N., Miyadzu, T. and Ogura N. (1994)
2 Rapid removal of linear alkylbenzene sulfonate by attached biofilm in an
3 urban shallow stream. *Water Research*, 28(9), 1953-1960.
- 4 Toräng, L., Reuschenbach, P. Muller, B. and Nyholm N. (2002) Laboratory shake
5 flask batch tests can predict field biodegradation of aniline in the Rhine.
6 *Chemosphere* 49, 1257–1265.
- 7 USEPA (1994) *Aniline Fact Sheet: Support Document*. OPPT Chemical Fact Sheets.
8 USEPA Office of Pollution Prevention and Toxics, Washington DC.
- 9 Volpi Ghirardini A.M., Arizzi Novelli A., Likar, B., Pojana, G, Ghetti, P.F. and
10 Marcomini, A. (2001) Sperm cell toxicity test using sea urchin *Paracentrotus*
11 *Lividus* Lamarck (Echinodermata: Echinoidea): Sensitivity and discriminatory
12 ability toward anionic and nonionic surfactants. *Environmental Toxicology*
13 and Chemistry 20(3), 644–651.
- 14 Whelan, M.J., Gandolfi, C. and Bischetti, G.B. (1999) A Simple Stochastic Model of
15 Point Source Solute Transport in Rivers based on Gauging Station Data with
16 Implications for Sampling Requirements. *Water Research* 33(14), 3171-3181.
- 17 Whelan, M.J., van Egmond, R., Guymer, I., Lacoursiere, J.O. , Vought, L.M.B.,
18 Finnegan, C., Fox, K.K., Sparham, C., O'Connor, S., Vaughan, M. and
19 Pearson, J.M (2007) The Behaviour of Linear Alkyl Benzene Sulphonate
20 Under Direct Discharge Conditions in Vientiane, Lao PDR. *Water Research*
21 41(20), 4730-4740.
- 22

1

2

3 **Table 1.** Average and SD of water quality variables measured in the test medium4 used in the study. In all cases $n = 21$.

5

	COD	NH₄-N	TN	PO₄-P	Temp	pH	DO	TDS	EC
Units	mg L ⁻¹	mg N L ⁻¹	mg N L ⁻¹	mg P L ⁻¹	°C		mg L ⁻¹	ppt	mS cm ⁻¹
Average	90.3	9.0	24.8	2.1	19.9	8.14	4.8	0.6	1.2
SD	9	0.9	2.6	0.2	0.3	0.05	0.6	<0.1	<0.1

6

7

8

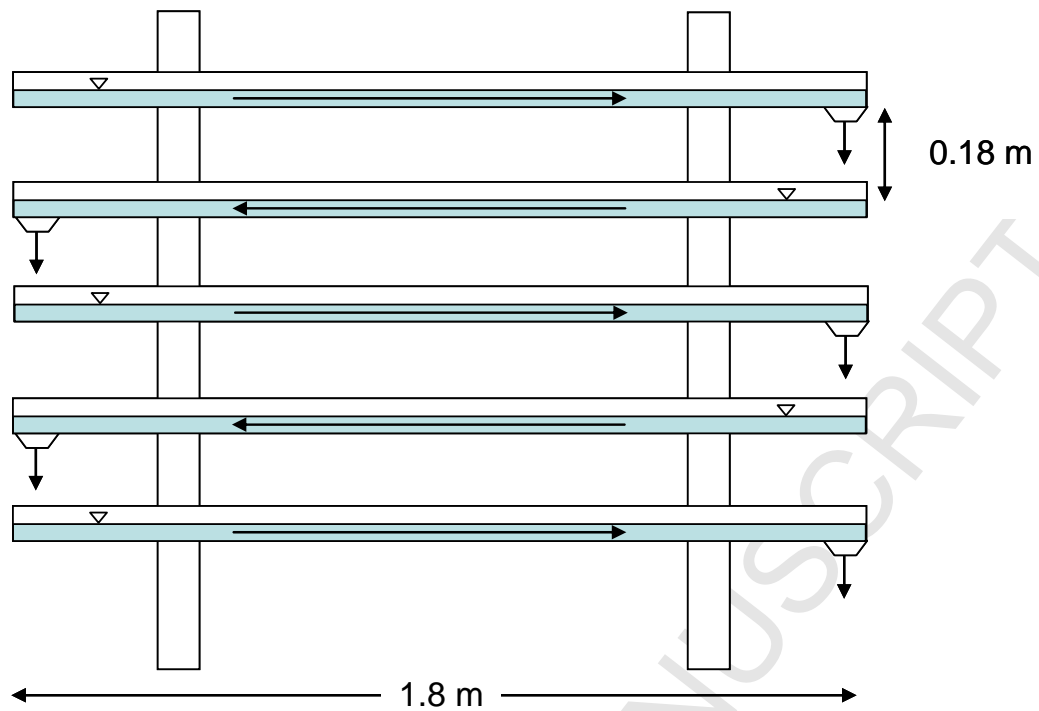

Figure 1 Schematic representation of the test apparatus illustrating direction of flow (not to scale).

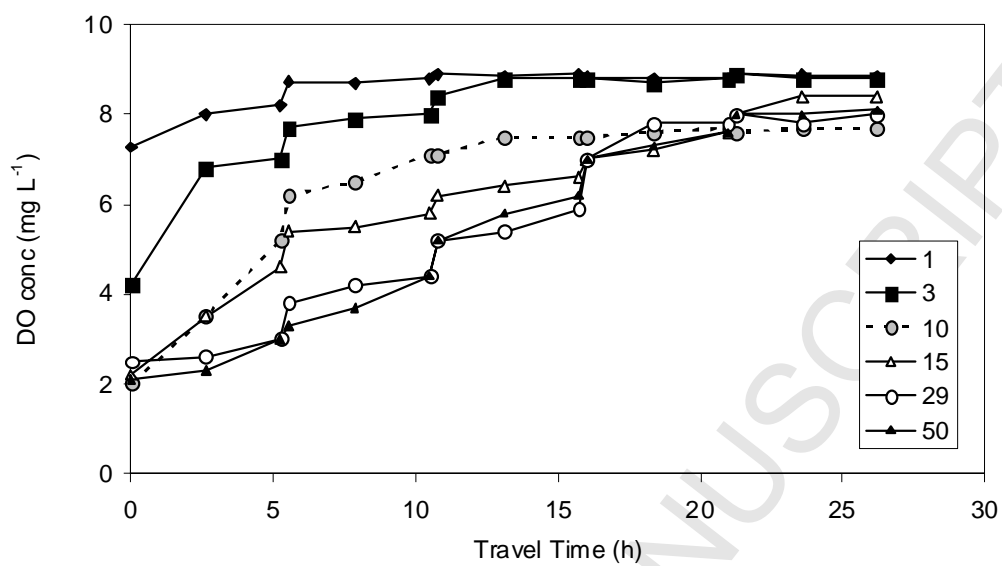

Figure 2 Observed dissolved oxygen concentrations with distance downstream through the cascade on different days (1, 3, 10, 15, 29, 50) of the study.

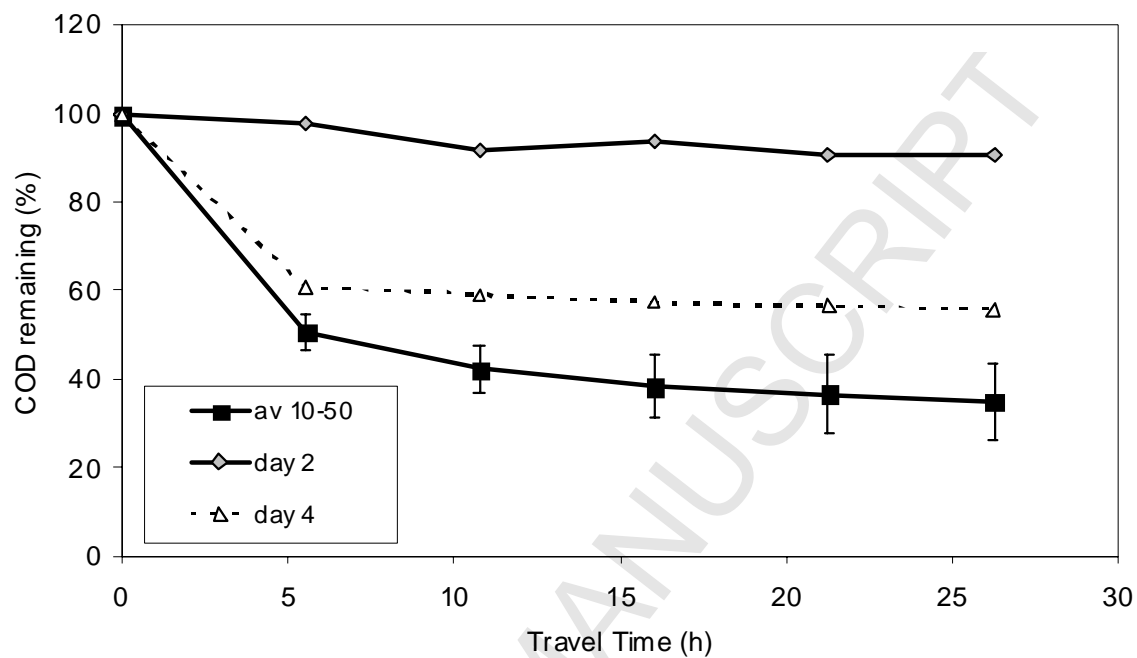

Figure 3 Observed changes in COD concentrations (normalised to the initial concentration) with travel time through the cascade on different days of the study (day 2, day 4 and the average \pm SD of days 10-50).

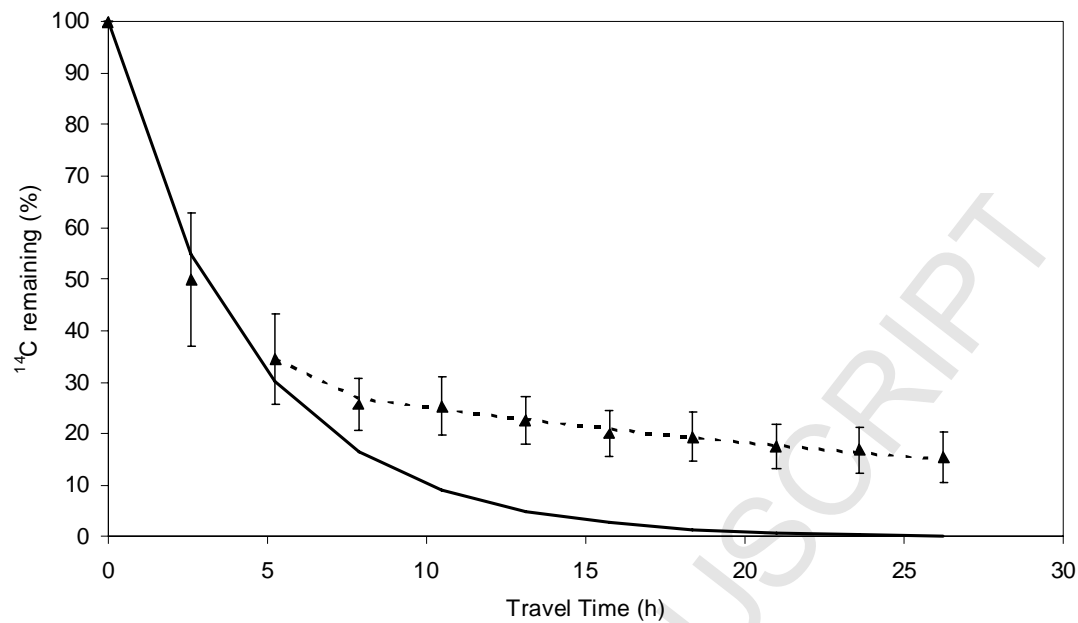

Figure 4 Fraction of aniline (counts) remaining with travel time along with best-fit solutions to first order kinetics for the first channel (solid line) and for channels 2 to 5 only (dashed line). Error bars show the measured mean $1 \pm \text{SD}$.

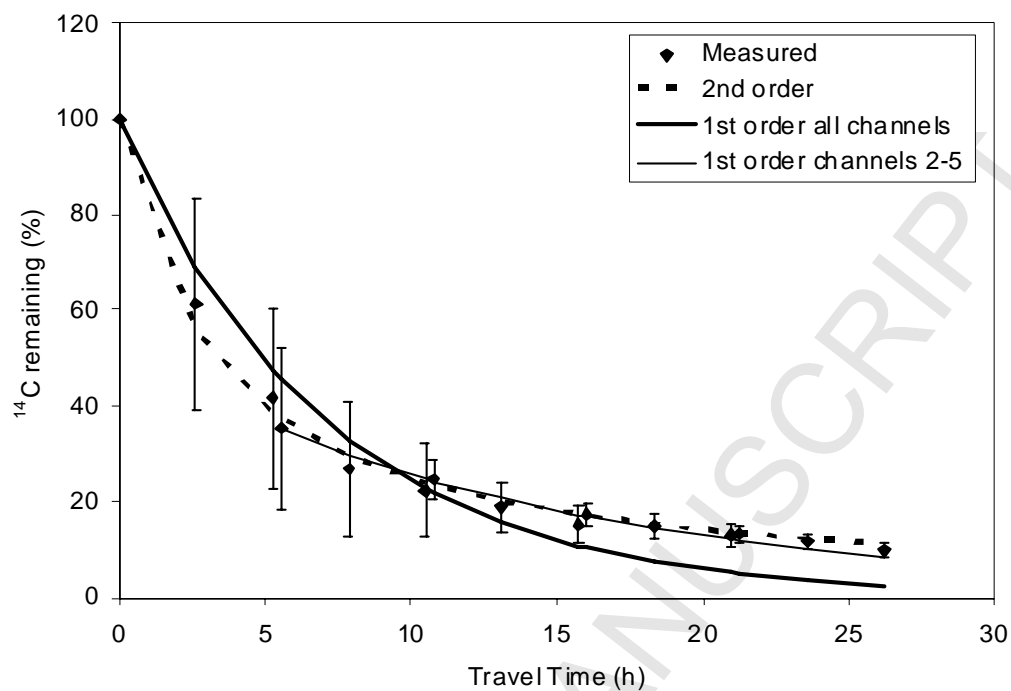

Figure 5 Observed and fitted pattern of the fraction of radiolabelled LAS (^{14}C Phenyl 6 DOBS) remaining with travel time in the cascade. Thick solid line shows the first order kinetic fit, the dashed line shows a second order fit and the thin solid line shows a first order fit to data from channels 2-5 only. Error bars show the measured mean $1 \pm \text{SD}$.

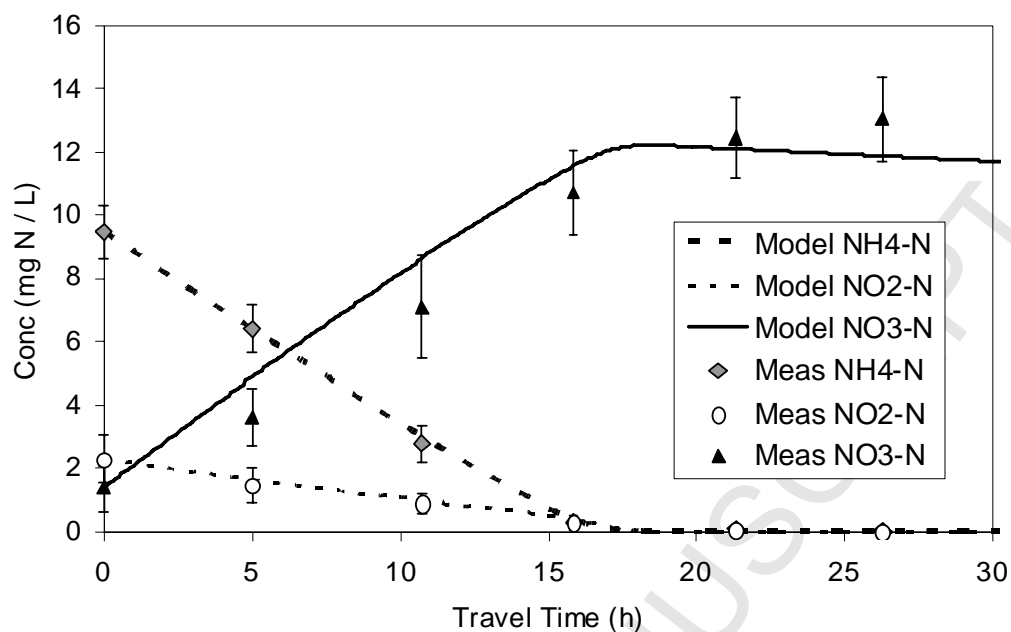

Figure 6 Mean measured and modelled mineral nitrogen concentrations in the cascade under steady-state conditions. Error bars show the measured mean \pm 1 SD ($n = 12$).