

Design of a motorised plasma delivery system for ultra-precision large optical fabrication

Hui Zhou¹, Adam Bennett¹, Marco Castelli², Renaud Jourdain¹,
Jiang Guo³  and Nan Yu⁴ 

¹ Surface Engineering and Precision Institute, Cranfield University, Bedford, United Kingdom

² Manufacturing Technology Centre (MTC), Coventry, United Kingdom

³ Key Laboratory for Precision and Non-traditional Machining Technology of Ministry of Education, Dalian University of Technology, Dalian, People's Republic of China

⁴ Centre of Micro/Nano Manufacturing Technology, University College Dublin, Dublin, Ireland

E-mail: nan.yu@ucd.ie

Received 2 April 2020, revised 14 May 2020

Accepted for publication 30 July 2020

Published 2 September 2020



CrossMark

Abstract

A unique plasma figuring (PF) process was created and demonstrated at Cranfield University for manufacturing extremely large telescopes. The atmospheric pressure processing is faster and more cost-effective than other finishing processes; thus, providing an important alternative for large optical surfaces. The industrial scale manufacturing of thousands of ultra-precision metre-scale optics requires a robust PF machine: this requirement is achieved by making the plasma delivery system (PDS) performance repeatable. In this study, a dedicated PDS for large optical manufacturing was proposed to meet the industrial requirement. The PDS is based on an L-type radiofrequency (RF) network, a power supply, and an inductively coupled plasma torch. However, the complexities of these technologies require an in depth understanding of the integrated components that form the PDS. A smart control system for the modified PDS was created. This novel control system aims to make the characterization process deterministic: by automating the tuning of critical electrical components in the RF network, which is achieved by the use of in-line metrology. This paper describes the main design aspects. The PDS was tested with a good correlation between capacitance and RF frequencies. The robust PDS design enables a stable discharge of plasma with a low deviation of RF signals during the total 15 hours' test.

Keywords: plasma figuring, inductively coupled plasma, RF network, plasma delivery system

(Some figures may appear in colour only in the online journal)

1. Introduction

Several world-class scientific facilities (e.g. extremely large telescopes [1], EUV lithography [2], and laser fusion plants [3]) require thousands of meter-scale ultraprecision optics.

The challenge is not just in the manufacturing of optical components to a nanometre level form accuracy and sub-nanometre level surface roughness [4] but also in reducing production time and cost [5]. Plasma processing is a non-contact material removal process working at atmospheric pressure and based on low-cost consumables for metal treatment [6] or optical surface figuring [7–11]. The surface roughness after plasma figuring (PF) could reach up to 1 nm RMS with a minimum number of iterations. State-of-the-art atmospheric plasma etching techniques mainly include capacitively coupled plasma (CCP) [7, 9, 11], inductively



Original content from this work may be used under the terms of the [Creative Commons Attribution 3.0 licence](https://creativecommons.org/licenses/by/3.0/). Any further distribution of this work must maintain attribution to the author(s) and the title of the work, journal citation and DOI.

coupled plasma (ICP) [12, 13], and microwave induced plasma (MIP) [8]. In this study, the PF process focuses on the ICP plasma generation using a radiofrequency (RF) power source. Previous research indicates that PF is a rapid ultraprecision technique to correct large optical surfaces [12, 13]. However, to be considered as a commercially viable mass production alternative for large-scale precision optics, a stable plasma for processing activities is an essential criterion.

Two PF machines were developed at Cranfield University together with RAPT Industries Inc: RAP300 and Helios 1200 (shown in figure 1). As opposed to the RAP300, which is a small-scale prototype facility [14], the processing capacity of Helios1200 was conceived for the rapid PF process of large optics up to 1.2 m diameter at atmospheric pressure [15]. These machines combine plasma technology operating at atmospheric pressure and computer numerically controlled (CNC) motion systems. In each machine, an RF ICP atomizes a reactive gas, which creates free radicals. However, the two RF plasma systems are different. The RAP300 is equipped with an auto-tuning RF matching network, whereas the Helios1200 is equipped with a fixed-match RF network [16]. When the optical substrate is scaled up to one-meter size, the RF network and ICP torch cannot be fixed at one position anymore, because the 2-D motions of the substrate would require too much room of the machine. The fixed match RF network on Helios 1200 was chosen to reduce the weight of the plasma torch assembly in the large optical fabrication, so the axis of the CNC system could drive the plasma torch assembly with better dynamic performances, and consequently achieve a higher capability to correct complex surfaces. However, this configuration of the axes lost the advantage of the matching network, which could reduce the reflected power to zero when environmental conditions change sharply (generator frequency $> \pm 20\%$) [17].

The Helios 1200 consists of three systems: plasma delivery system (PDS), CNC motion system, and scrubber system. The PDS was designed and developed to address the extreme manufacturing challenge of creating hundreds of ultra-precision optical surfaces using the PF process. The purpose of this research focuses on developing a hybrid PDS for supporting a deterministic PF process, assisting the machine operator by tuning key electrical components in the RF network, and monitoring important processing parameters.

2. Existing PDS in the experiment

Figure 2 shows the CAD model and the circuit diagram of the PDS used in Helios1200. The PDS included three main electrical components: RF power supply, transmission line, and RF network (two capacitors and a coil). The impedance occurred in the form of inductance, capacitance, and resistance. The RF power supply consisted of a COMDEL CV2000/40.68 MHz RF generator. The RF generator contains a frequency ‘Agile’ autotuning control logic [17] that adjusts the output frequency. The frequency ranges from 38.5 to 42.5 MHz, suitable to match the eigen-frequency of Ar

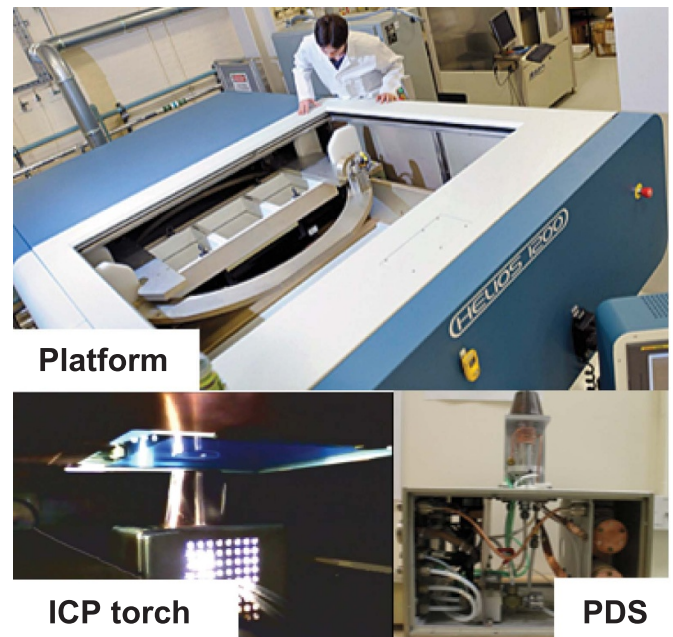

Figure 1. Helios 1200 plasma figuring machine, including ICP torch, PDS and other parts.

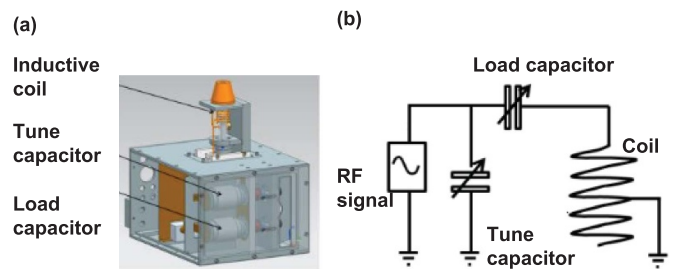

Figure 2. (a) CAD model of the PDS including: ICP torch and two capacitors as shown. (b) Circuit diagram of the PDS and its RF network.

plasma. The RF generator has the capability to provide 2000 W and is designed for a 50 Ohm load.

The fixed match network was carefully engineered (figure 2(b)) to secure the optimum performance of a bespoke ICP torch. In this system, an accurate match was achieved by auto-tuning the frequency via the Agile algorithm, which responds to changes in reflected power based on certain threshold criteria and attempts to find the minimum reflected power in real-time. By monitoring changes in the voltage standing wave ratio (VSWR) of the system during manufacturing, the power received by the coil can be maintained by reducing the original power. This method does not completely eliminate the reflected power, so the RF generator was controlled by ‘delivered power’ rather than ‘forward power’. A pseudo L-type RF network [18] was chosen because it can deliver power into a relatively large output coil, limited only by the practical voltage ratings of the tune capacitor and the resonance frequency of the coil. Variations in the load impedance caused by tuning of the forward power will lead to unstable

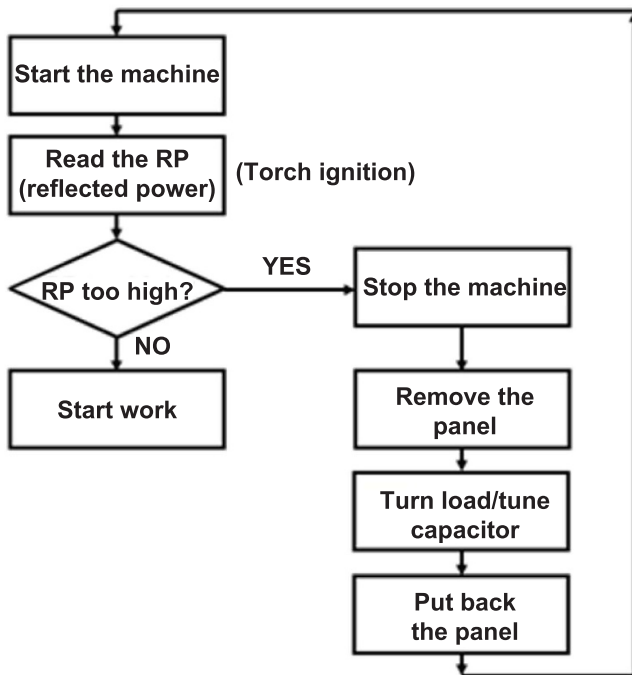

Figure 3. Flow chart of the current procedure for the fixed match network setting.

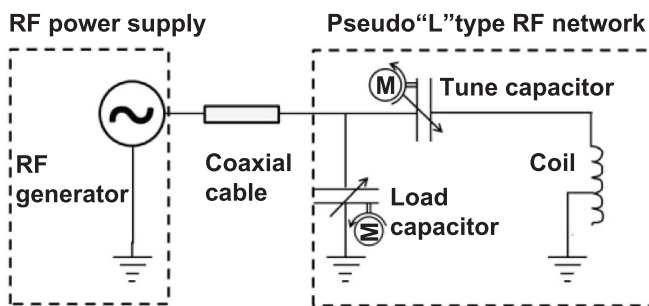

Figure 4. The novel PDS design including RF power supply and a modified RF network with motorized capacitors.

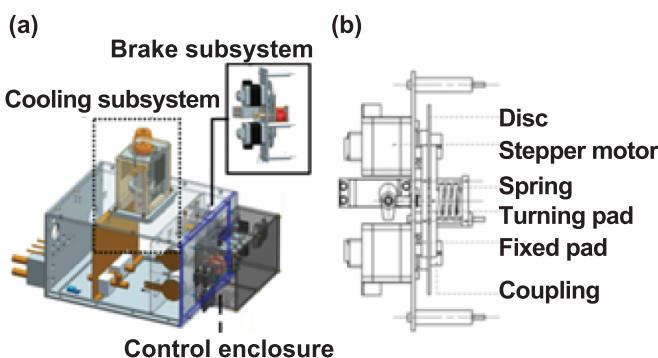

Figure 5. (a) CAD model of the novel PDS design, including three major modifications in brake, cooling and control enclosure. (b) Design of the brake subsystem, including disc, step motor, spring, turning pad, fixed pad and coupling.

frequency adjustment. Figure 3 highlights the complexity of operating the current PDS.

Important features were identified for the entire range of operations. The novel features of the control system address plasma ignition, regular plasma delivery, and critical circumstances. These three phases occur during the standard operations of the machine.

Phase 1: The plasma ignition phase is characterized by a moderate RF signal power (~300 W) and involves tuning the capacitors.

Phase 2: The regular plasma delivery phase (~1.2 kW) is characterized by monitoring various parameters, such as reflected power, coolant temperature, and gas temperature.

Phase 3: ‘Critical circumstance’ is a phase where unexpected events may occur. The PDS needs to be shut down to preserve its integrity.

The novel PDS is proposed to solve the aforementioned problems.

3. Novel PDS design

The novel design of PDS presented in the following sections meets the requirements of the three phases. This design entails RF network modification, mechanical design, and digital control strategy.

3.1. RF network modification

In this project, a fixed match circuit design brings fast tuning and reliability to the PDS. To secure the process determinism for the high frequency RF generator machine, the RF network was enhanced by protecting the electrical components and motorizing the fixed match design.

Admittedly, a plasma processing system becomes more process specific presenting a narrower range of impedances to the RF delivery system, which is the fundamental premise for fixed match. After ignition, the impedance of the system stabilizes if no external disturbances intervene. The new control system aims at maintaining the plasma in stable condition for long process duration. To achieve this, temperature increase of the electrical components, environmental perturbations, and process parameter variations were monitored. By means of actuators, sensors, and a micro controller, the impedance of the load was adjusted by tuning the values of the two vacuum capacitors (tune and load). These capacitance values were changed using stepper motors mounted on the end of cylindrical vacuum capacitors. In addition, the free running RF signal generator was used to finely and rapidly determine the optimum output frequency. Figure 4 illustrates the modified RF network after motorizing the capacitors.

3.2. Mechanical design

Three main components were modified to achieve the motorized capacitor circuit design as shown in figure 5. Firstly, a brake subsystem design was introduced to tune the two capacitors to change the impedance of the motorized fixed match of the whole system. Secondly, a modified enclosure for the control system was created to house additional electrical devices. Thirdly, the new electrical assemblies required

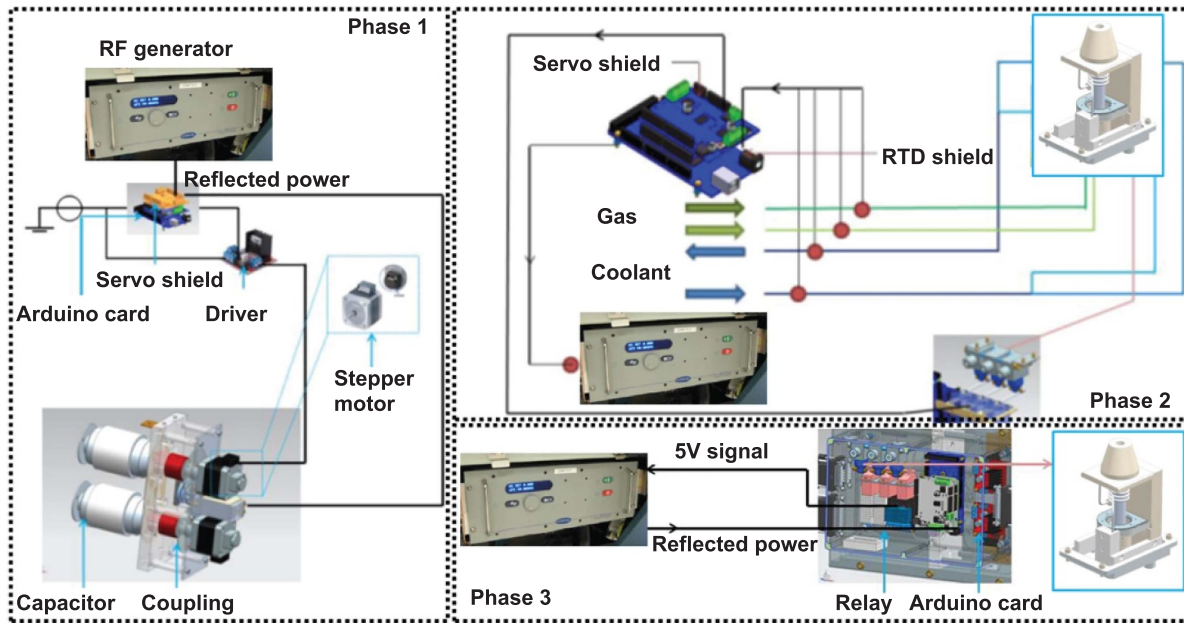

Figure 6. Schematics of the working principles in three phases: ignition, regular operation, and critical circumstance.

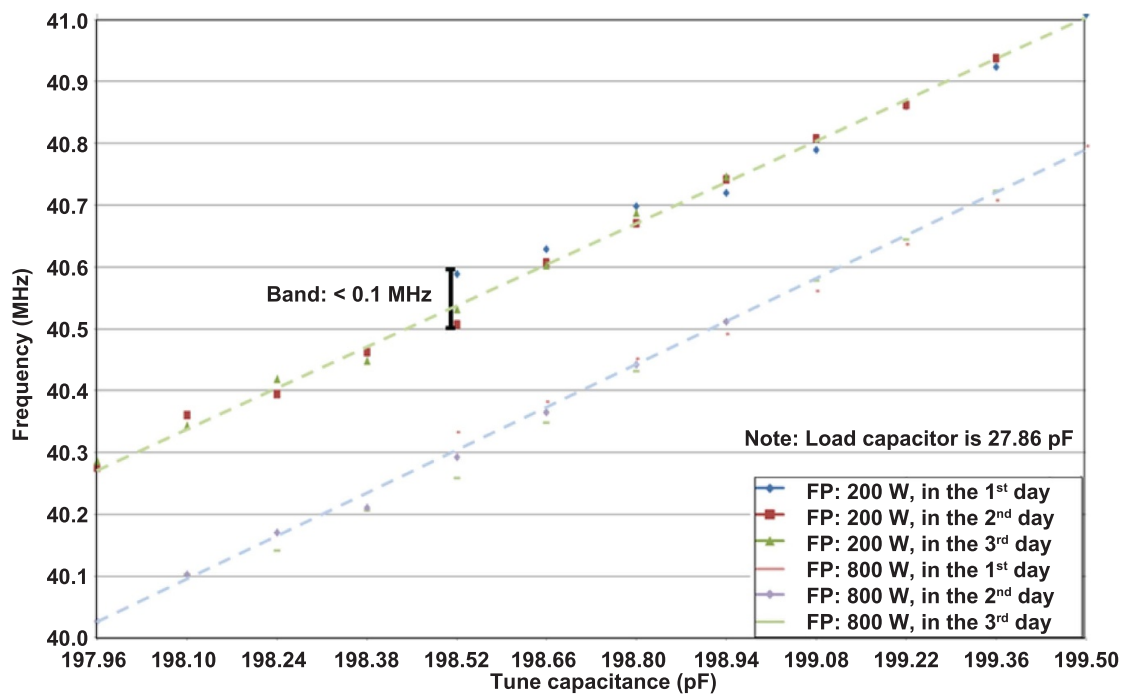

Figure 7. Frequency versus tune capacitance. Data acquisition when the load capacitor is fixed at 27.86 pF, from continuous three days with forward power (FP) in 200 W and 800 W respectively. The band of data from three collections is less than 0.1 MHz.

a cooling subsystem. Therefore, a cooling gas feed structure was added to the construction of the torch. This paper provides a detailed description of the brake system.

A brake subsystem is crucial to turn the impedance of capacitors, driven by the Ariuno Mega with self-locked design. Two stepper motors rotated the capacitors. These parts were connected by two in-house designed couplings. In static conditions, the stepper motors are held by two brake pads being

pushed by a spring. Since the two discs are physically connected to the stepper motor, the frictional force caused by brake pads holds the motor. Servomotors (i.e. SAVOX 1283 Servo) triggered the ‘open-close’ status of the three phases. Once the system starts working, the pressing the brake pads on the servomotor opens the brake. The stepper motors turn the capacitor, closing the brake system. Each of these tuning actions must be completed during the open period. The force

Table 1. Hardware in the PDS control.

Phase	Electronic elements	Function	Parameters
Phase 1: Ignition	Stepper motor x 2	Adjustment of capacitors' position	6 digital output, 4 in full use; 1.5 A per phase (for each) Totally: 12 digital output ($2 \times 6 = 12$ outputs)
	Encoder x 2	Determining the capacitors' reading precisely	Output 3- channel input current (mA): ≤ 30 input voltage (V): $5 \pm 10\%$
	Signal acquisition	Tuning the impedance of the torch by changing capacitors' value	1 analog input
Phase 2: Regular operating	RTD sensor x 2	Monitoring the temperature of the coolant	Connection terminal: RTD shield
Phase 3: Critical circumstance	Gas supply	Shut down when reflective power rushes	1 digital output 1 ground

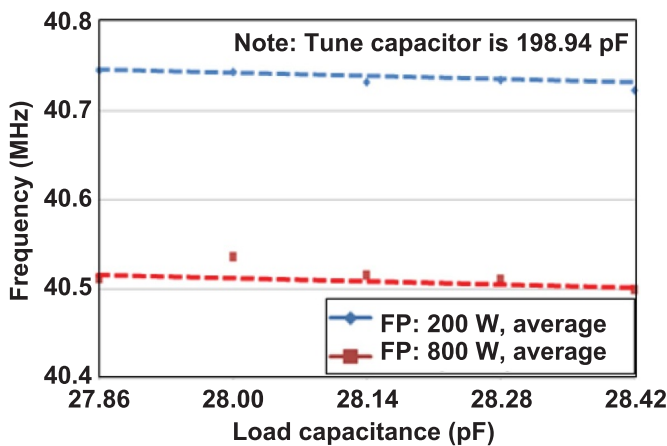

Figure 8. Frequency versus tune capacitance. Data acquisition when the tune capacitor is fixed at 198.94 pF, averagely from continuous three days with forward power (FP) in 200 W and 800 W respectively. The band of data from three collections is less than 0.01 MHz.

and torque were calculated to meet the holding and tuning requirements.

3.3. Control strategy

For controlling all the subsystems in the PDS, the electronic devices were selected to integrate with an Arduino Mega card, which is an open-source prototyping platform. The hardware for the three phases is summarized in table 1.

Three parts in the electrical circuit should be noted: servomotors for valves; a servomotor for the brake subsystem to open and lock; and two stepper motors for turning. The two stepper motors are 2-phase motors with a 4-wire structure, and 2-phase drivers are needed to rotate the motors in the correct angle and direction. The servomotor can be rotated by up to 90 degrees with the torque provided by the 5 V driving force. Similarly, three servomotors for valves were connected to electrical ports (independent PWM, 5 V forward power, ground).

Figure 6 illustrates the control strategy in the three stages. In Phase 1 (ignition), the chosen solution aims at quickly tuning the RF network via the two stepper motors (one per capacitor) activated by Arduino Mega, which is based on ATmega2560. In order to lock the capacitors position during

the plasma process, a brake system was added between each motor and capacitor. This normally closed brake was activated by a servomotor controlled by the Arduino Mega running the stepper motor. In Phase 2, to enable monitoring functionality during regular operations, RTD sensors were embedded into the cooling subsystem of the PDS. The application of Arduino technology effectively to evaluated the data via a special shield stacked on the control card. In the case of critical circumstances occurrence (Phase 3), the work focused on hardware alterations, such as support plates modification, addition of cooling gas structures, and remote ON/OFF functionality for the RF generator.

4. Test of the PDS and results

The stability of the RF network of the PDS was tested. A series of permutation and a combination of both capacitors were set, and the frequencies at specific forwarded RF power were logged. Repeatable frequencies at each setting for the plasma generation of long-period time would reflect the stability of the RF network. The relation between frequencies and capacitor tuning were recorded. The tune capacitor was turned from 197.96 pF to 199.50 pF and increased by 0.77%, while the load capacitor remained fixed at 27.86 pF. Figure 7 presents the logged data of the frequencies for each tune capacitance setting. The plasma was ignited with forwarded power at about 250 W and maintained at E-mode until the RF power increased to 800 W. Frequencies were recorded at 200 W before ignition and 800 W in E-mode (electric field dominates), respectively. The plasma transferred into H-mode (magnetic field dominates) when the RF power exceeded 800 W, which is considered to be in the status of plasma processing. Each plasma ignition at different capacitance settings lasted over 20 min at H-mode. Experiments were undertaken within three days, and the frequencies appeared to be repeatable, with a maximum deviation of 0.1 MHz. The two linear fitting lines shown in figure 7 highlight the correlation between frequencies and tune capacitance at each RF power.

Following the aforementioned results, the load capacitor was turned from 27.86 pF to 28.42 pF and increased by 2%, while the tune capacitance remained fixed. The tune capacitance of 198.94 pF was chosen due to the low and consistent ignition power achieved at this value. Similarly,

figure 8 displays the frequency values against the given load capacitance. The optimum frequency determined by the RF generator remained relatively stable. This observation contrasts with the results shown in the previous section-tune capacitance response (figure 8).

The investigation highlighted that the tune capacitance is more sensitive than the load capacitor in a stable PDS. A total of 15 settings of tune and load capacitances contributed over 900 ($=20 \times 15 \times 3$) minutes of plasma generation. This manuscript presents a robust design of PDS, focused on its unique RF network, which is proven to be stable and repeatable in terms of its RF frequencies. Future research will focus on the effects of moving the ICP torch, which is expected to generate plasma for 3 h, and the results will be tested against the stability of its material removal footprint.

5. Conclusion

In order to enhance the processing capability of plasma delivery systems used in CNC machine tools and created for high-end optical fabrication, a highly reliable and deterministic plasma delivery system (PDS) was designed, manufactured, and tested to satisfy the requirements of ultra-precision applications. The existing L type fixed match RF circuit was modified with motorized capacitors. Mechanical design adjustments in the braking subsystem, cooling subsystem and control enclosure were made. The major conclusions are listed as below:

1. A novel PDS with a fixed match RF network was designed for industrial demand of manufacturing large optics. The robust PDS design enables stable discharge of plasma for an extended duration.
2. The control strategy for the three process control phases enables the robust tuning of the RF network. Important features were identified for the entire range of operations, addressing plasma ignition, regular plasma delivery, and critical circumstances.
3. The PDS system was tested by tuning the capacitors. A linear relationship between frequency and tune capacitor value was achieved. Evidence of repeatable frequency signals in the test of plasma generation of over 900 min indicates the stability of the RF network. The tested system is ready for rapid processing of optics in future work.

Acknowledgments

This research work was partially funded by Engineering and Physical Sciences Research Council (EPSRC) UK through EPSRC Centre for Innovative Manufacturing in Ultra Precision grant (EP/1033491/1), and Irish Research Council co-funded by Marie Skłodowska-Curie Actions (CLNE/2018/1530). Finally, our appreciation is given to Cranfield University for the use of their facilities and to Professor Paul Shore for his support in this project.

ORCID iDs

Jiang Guo  <https://orcid.org/0000-0002-9523-7881>

Nan Yu  <https://orcid.org/0000-0002-5684-1752>

References

- [1] Gilmozzi R and Spyromilio J 2007 The European extremely large telescope (E-ELT) *Messenger* **127** 3
- [2] Tallents G, Wagenaars E and Pert G 2010 Optical lithography: lithography at EUV wavelengths *Nat. Photon.* **4** 809–11
- [3] Lawrence Livermore National Laboratory 2020 National ignition facility & photon science (<https://lasers.llnl.gov/>)
- [4] Xu M J, Dai Y F, Zhou L, Peng X Q, Chen S S and Liao W 2018 Evolution mechanism of surface roughness during ion beam sputtering of fused silica *Appl. Opt.* **57** 5566–73
- [5] Shore P, Cunningham C, DeBra D, Evans C, Hough J, Gilmozzi R, Kunzmann H, Morantz P and Tonnellier X 2010 Precision engineering for astronomy and gravity science *CIRP Ann.* **59** 694–716
- [6] Guo J, Zhang J G, Pan Y N, Kang R K, Yoshiharu N, Paul S, Xiaobin Y, Baorui W and Dongming G 2020 A critical review on the chemical wear and wear suppression of diamond tools in diamond cutting of ferrous metals *Int. J. Extreme Manuf.* **2** 012001
- [7] Sun R Y, Yang X, Ohkubo Y, Endo K and Yamamura K 2018 Optimization of gas composition used in plasma chemical vaporization machining for figuring of reaction-sintered silicon carbide with low surface roughness *Sci. Rep.* **8** 2376
- [8] Arnold T, Boehm G and Schindler A 2001 Ultrahigh-rate plasma jet chemical etching of silicon *J. Vac. Sci. Technol.* **19** 2586–9
- [9] Takino H, Yamamura K, Sano Y and Mori Y 2012 Shape correction of optical surfaces using plasma chemical vaporization machining with a hemispherical tip electrode *Appl. Opt.* **51** 401–7
- [10] Jourdain R, Castelli M, Yu N, Gourma M and Shore P 2016 Estimation of the power absorbed by the surface of optical components processed by an inductively coupled plasma torch *Appl. Therm. Eng.* **108** 1372–82
- [11] Jin H L, Xin Q, Li N, Jin J, Wang B and Yao Y 2013 The morphology and chemistry evolution of fused silica surface after Ar/CF₄ atmospheric pressure plasma processing *Appl. Surf. Sci.* **286** 405–11
- [12] Castelli M, Jourdain R, Morantz P and Shore P 2012 Rapid optical surface figuring using reactive atom plasma *Precis. Eng.* **36** 467–76
- [13] Yu N, Jourdain R, Gourma M and Shore P 2016 Analysis of De-Laval nozzle designs employed for plasma figuring of surfaces *Int. J. Adv. Manuf. Technol.* **87** 735–45
- [14] Fanara C, Shore P, Nicholls J R, Lyford N, Kelley J, Carr J and Sommer P 2006 A new reactive atom plasma technology (RAPT) for precision machining: the etching of ULE[®] surfaces *Adv. Eng. Mater.* **8** 933–9
- [15] Yu N, Yang Y, Jourdain R, Gourma M, Bennett A and Fang F 2020 Design and optimization of plasma jet nozzles based on computational fluid dynamics *Int. J. Adv. Manuf. Technol.* **108** 2559–68
- [16] Jourdain R, Castelli M, Shore P, Sommer P and Proscia D 2013 Reactive atom plasma (RAP) figuring machine for meter class optical surfaces *Prod. Eng.* **7** 665–73
- [17] XP Power AG 2020 RF power systems (<https://www.xppower.com/rf-power>)
- [18] Li R C 2009 *RF Circuit Design* (Hoboken, NJ: Wiley)

2020-09-02

Design of a motorised plasma delivery system for ultra-precision large optical fabrication

Zhou, Hui

IOP

Zhou H, Bennett A, Castelli M, et al., (2020) Design of a motorised plasma delivery system for ultra-precision large optical fabrication. *International Journal of Extreme Manufacturing*, Volume 2, Issue 4, 2020, Article number 045301

<https://doi.org/10.1088/2631-7990/abab49>

Downloaded from Cranfield Library Services E-Repository