

Optimal PIP Control of a pH Neutralization Process Based on State-Dependent Parameter Model

Oluwaseyi A. Ogun* Mbetobong U. Festus**
 Isonguyo J. Inyang***

* *Control Theory and Applications Centre, Coventry University, Coventry, CV1 5FB, UK (e-mail: ogun.o.a@keemail.me)*

** *Electrical and Electronics Engineering Department, Akwa Ibom State University, Akwa Ibom State, Nigeria (e-mail: festus_mb@yahoo.com)*

*** *School of Aerospace, Transport and Manufacturing, Cranfield University, Bedfordshire, MK43 0AL, UK (e-mail: i.inyang@cranfield.ac.uk)*

Abstract: In this paper, an optimal Proportional-Integral-Plus (PIP) controller based on State-Dependent Parameter (SDP) model is developed to control a highly nonlinear and time-varying pH neutralization process. Since the reaction invariants of the pH process are unavailable for direct measurement, a state observer is required for their estimation. Unfortunately, a closed-loop state observer cannot be designed for the pH process due to the decoupled nature of the reaction invariant dynamics. However, this problem is circumvented by engaging the power of State Variable Feedback (SVF) in the context of a Non-Minimum State Space (NMSS) framework. Furthermore, to compensate for process nonlinearities and unmeasured disturbances, an SDP model is identified using data collected from open-loop experiment, and a straightforwardly tuned optimal PIP controller is subsequently designed based on the SDP model to obtain the SDP-PIP controller. For benchmark purposes, a digital PI controller is designed and results are compared with those from the SDP-PIP controller. Simulation results show that SDP-PIP outperforms PI both in set point and disturbance changes.

Keywords: Proportional-Integral-Plus (PIP), Linear Quadratic (LQ), State Variable Feedback (SVF), State-Dependent Parameter (SDP), pH Neutralization

1. INTRODUCTION

Contrary to classical control in which control system designs are based on the graphical root locus and frequency response techniques, modern control designs are based on state space formulation of the dynamic system and using the concept of State Variable Feedback (Friedland, 1986), the poles of the closed-loop system can be arbitrarily assigned to desired locations on the z -plane such that certain control objectives (e.g. stability) are satisfied. Of course, impressive results are often achieved via pole placement and the state space formulation allows for compatibility with several powerful control strategies such as H_2 and H_∞ control (Zhou and Doyle, 1998; Skogestad and Postlethwaite, 2007). However, the minimal state space formulation requires the use of observers to estimate unknown states and this estimation introduces additional complexity and decreases robustness (Skogestad and Postlethwaite, 2007). On this note, the introduction of Proportional-Integral-Plus control design based on Non-Minimum State Space formulation (Young et al., 1987) eliminates the drawback. Here, the state vector is composed of current sampled output and past input and output sampled values which can be stored and then made readily available for the SVF control law.

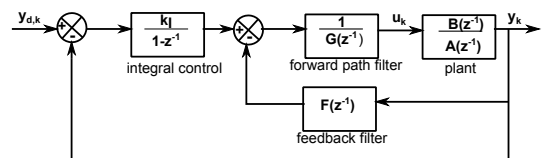

Fig. 1. Standard PIP feedback structure

A typical PIP control system is shown in Fig. 1, and comparison with the classical PI/PID control can be drawn. For example, based on Fig. 1, a PI structure can be obtained when the input compensator, $G(z^{-1})$ is unity and the feedback compensator, $F(z^{-1})$ is a proportional controller. This structure mainly occurs with simple first order systems with one sample delay. On the other hand, when the system is of higher order than one and/or delayed by more than one sample, then higher order terms are automatically introduced in the feedback and/or input compensator (Taylor et al., 1998a). It is worthy of note that despite the similarity between PI and PIP structure, PIP design offers more interesting features, for e.g., erratic manual tuning of classical control design is superseded by the pole placement or Linear Quadratic design (Taylor et al., 2000). Successful practical applications of PIP

control can be found in Young et al. (1994), Norris et al. (1996) and Taylor et al. (1998b).

The idea of pH is very crucial to human and nature lives. For example, for optimal plant performance, soil pH must be maintained between $6 \leq \text{pH} \leq 8$ otherwise, certain soil nutrients are depleted and plant yield is adversely affected (Singer et al., 2012). In pharmaceutical industries, tight control of pH is vital (Johnson, 1987) as it affects the solubility, stability and permeability of drugs through biological membrane. Waste water from treatment plants must be neutralized before discharge and must be maintained within stringent environmental limits. With that being said, control of pH is a topic of interest. However, controlling pH processes is a very challenging one due to inherent nonlinearity and process uncertainties. Hence, diverse nonlinear and adaptive control techniques have been proposed to this end. Mahmoodi et al. (2009) developed a nonlinear model predictive controller based on Weiner-Laguerre model, but assumes availability of reaction invariants for online measurement, and a constant buffer stream which does not capture, in reality, the time-varying nature of industrial processes. Henson and Seborg (1994) proposed an adaptive nonlinear controller by combining an input-output linearizing controller with a parameter estimator, but uses open-loop observers, which decrease robustness (Skogestad and Postlethwaite, 2007), to estimate the reaction invariants. Gustafsson and Waller (1983) derived a reaction invariant model of the pH process using a linear transformation technique, appropriate for linear control theory. Böling et al. (2005) proposed a multi-model adaptive PID controller based on a set of linear dynamic models for pH neutralization process.

In this paper, a highly nonlinear bench-scale pH neutralization system of the University of California, Santa Barbara (UCSB), shown in Fig. 2, is controlled in the face of disturbances. Here, a different control methodology is considered which avoids the time-consuming adaptive control design and the use of state observers which decrease robustness, yet addressing nonlinearity and time-varying nature of the pH process. Since the PIP control system is a digital control system, controller designs are based on discrete time linear models which can be obtained from open-loop identification experiments or a linearized model of the continuous time system and subsequent discretization. In this case, a first order discrete-time SDP bilinear model is selected for identification as this model is able to extend the operational range of the controller, and being state-dependent in the parameter, re-parameterization takes place (which is needful to capture the time-varying characteristics of the pH process) at every time instant and controller gains are simultaneously updated at each such time, hence, compensating for process nonlinearity. Identification is based on a Generalized Binary Noise (GBN) which has been industrially proven to be effective and hence, recommended for linear identification (Zhu, 2001). Based on the identified SDP model, an optimal PIP controller is designed for the pH neutralization process and results are compared with those from a digital PI controller.

This paper is organized such that SDP modelling is discussed in Section 2. The PIP control formulation is highlighted in Section 3, while a simulation study on pH

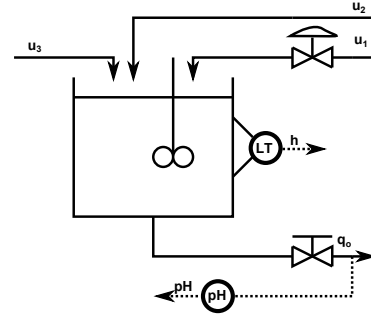

Fig. 2. Schematic diagram of the UCSB pH neutralization process.

neutralization process is discussed in Section 4. Finally, conclusions are presented in Section 5.

2. STATE-DEPENDENT PARAMETER MODELLING

SDP models are particularly useful when the system to be modelled is truly nonlinear, and changes in the model parameters are functions of system states (Taylor et al., 2013). The use of SDP models in PIP control design for nonlinear systems was discussed in Young (1996) and McCabe et al. (2000), however, broader application in the context of control design can be found in Taylor et al. (2009, 2011). In this paper, the SDP model to be described is based on a bilinear model.

Since it is desired to have a model based controller that is as simple as possible, a simple model structure is used to capture the dynamics of interest for which the plant will be controlled. For processes which are truly nonlinear, a linear model structure with time or state invariance may be inappropriate to compensate for nonlinearity. Hence, a bilinear model structure is considered.

Considering the general discrete time SISO (Single-Input Single-Output) bilinear model in Nonlinear AutoRegressive Moving Average with eXogenous (NARMAX) input model representation form

$$y_k = \sum_{i=1}^n -a_i y_{k-i} + \sum_{i=0}^m b_i u_{k-d-i} + \sum_{i=0}^m \sum_{j=1}^n \eta_{i,j} y_{k-i-d} u_{k-i-j-d+1} + \xi_k \quad (1)$$

where a_i and b_i are parameters corresponding to the linear part, $\eta_{i,j}$ are the discrete bilinear coefficients which are identified together with a_i and b_i by suitable parameter estimation scheme, u_k and y_k are the input and output of the system respectively, d is the integer delay and ξ_k is an additive output disturbance signal. Equation (1) shows that a bilinear model is linear in input and output when considered separately with the bilinearity (nonlinearity) arising from the product of the input and output signal. To facilitate the development of SDP model, u and y are, henceforth, referred to as system states, and the bilinear coefficients are coalesced with either the a_i or b_i parameters. Thus, two possible choices emerge:

SDP model 1

In this case, we coalesce the bilinear terms with the a_i

coefficients in (1) to obtain

$$\tilde{a}_{i,k} = a_i - u_{k-d-i}\eta_{i-1} \quad (2)$$

where \tilde{a}_i is the modified SDP due to the u_{k-d-i} terms. Substituting (2) in (1), the SDP model 1 is given as

$$y_k = \sum_{i=1}^n -\tilde{a}_i y_{k-i} + \sum_{i=0}^m b_i u_{k-d-i} \quad (3)$$

SDP model 2

Here, the bilinear terms are coalesced with the b_i coefficients in (1) to have

$$\tilde{b}_{i,k} = b_i + y_{k-i}\eta_i \quad (4)$$

where \tilde{b}_i is the modified SDP due to the y_{k-1} terms. Substituting (4) in (1), the SDP model 2 is given as

$$y_k = \sum_{i=1}^n -a_i y_{k-i} + \sum_{i=0}^m \tilde{b}_i u_{k-d-i} \quad (5)$$

The decision to coalesce the bilinearity with a_i or b_i coefficients depends on application, and partly, on the user's choice (Burnham and Larkowski, 2011).

3. OPTIMAL PIP CONTROL FORMULATION

In this section, the design procedure of the proposed optimal PIP controller is described. Consider the general discrete time transfer function of a SISO model with inherent one sample delay ($b_0=0$) as:

$$y_k = \frac{B(z^{-1})}{A(z^{-1})} u_k \quad (6)$$

where u_k and y_k are the system input and output, respectively. $A(z^{-1})$ and $B(z^{-1})$ are polynomials defined as:

$$\begin{aligned} A(z^{-1}) &= 1 + a_1 z^{-1} + a_2 z^{-2} + \dots + a_n z^{-n} \\ B(z^{-1}) &= b_1 z^{-1} + b_2 z^{-2} + \dots + b_m z^{-m} \end{aligned} \quad (7)$$

where n and m are the orders of $A(z^{-1})$ and $B(z^{-1})$ polynomials respectively and $n > m$ for physical realizability, $b_1, \dots, b_m, a_1, \dots, a_n$ are the model parameters. z^{-1} denotes the backward shift operator which is very crucial to the control design since we are dealing with digital control system based on sampled data, so that the controller can refer to present and past input and output values. This is defined as

$$z^{-1} x_k = x_{k-1} \quad (8)$$

The NMSS formulation can be expressed as (Taylor et al., 2013):

$$\mathbf{x}_k = \mathbf{F} \mathbf{x}_{k-1} + \mathbf{g} u_{k-1} + \mathbf{d} y_{d,k} \quad (9)$$

and the associated output equation is

$$y_k = \mathbf{h} \mathbf{x}_k \quad (10)$$

where \mathbf{F} is the state transition matrix, \mathbf{g} is the input vector, \mathbf{d} and \mathbf{h} are the command input and output vectors, respectively.

$$\mathbf{F} = [f_a \quad f_b]$$

$$\mathbf{g} = [b_1 \quad 0 \quad 0 \quad \dots \quad 0 \quad 1 \quad 0 \quad 0 \quad \dots \quad 0 \quad -b_1]^T$$

$$\mathbf{h} = [1 \quad 0 \quad \dots \quad 0 \quad 0 \quad 0 \quad 0 \quad \dots \quad 0 \quad 0 \quad 0] \quad (11)$$

$$\mathbf{d} = [0 \quad 0 \quad 0 \quad \dots \quad 0 \quad 0 \quad 0 \quad 0 \quad \dots \quad 0 \quad 1]^T$$

\mathbf{F} is the concatenation of f_a and f_b , which are expressed as:

$$f_a = \begin{bmatrix} -a_1 & -a_2 & \dots & -a_{n-1} & -a_n \\ 1 & 0 & \dots & 0 & 0 \\ 0 & 1 & \dots & 0 & 0 \\ \vdots & \vdots & \ddots & \vdots & \vdots \\ 0 & 0 & \dots & 1 & 0 \\ 0 & 0 & \dots & 0 & 0 \\ 0 & 0 & \dots & 0 & 0 \\ 0 & 0 & \dots & 0 & 0 \\ \vdots & \vdots & \ddots & \vdots & \vdots \\ 0 & 0 & \dots & 0 & 0 \\ a_1 & a_2 & \dots & a_{n-1} & a_n \end{bmatrix} \quad (12)$$

$$f_b = \begin{bmatrix} b_2 & b_3 & \dots & b_{m-1} & b_m & 0 \\ 0 & 0 & \dots & 0 & 0 & 0 \\ 0 & 0 & \dots & 0 & 0 & 0 \\ \vdots & \vdots & \ddots & \vdots & \vdots & \vdots \\ 0 & 0 & \dots & 0 & 0 & 0 \\ 0 & 0 & \dots & 0 & 0 & 0 \\ 1 & 0 & \dots & 0 & 0 & 0 \\ 0 & 1 & \dots & 0 & 0 & 0 \\ \vdots & \vdots & \ddots & \vdots & \vdots & \vdots \\ 0 & 0 & \dots & 1 & 0 & 0 \\ -b_2 & -b_3 & \dots & -b_{m-1} & -b_m & 1 \end{bmatrix} \quad (13)$$

The non-minimum state vector, x_k is defined in terms of the present sampled outputs and the past sampled input and output values, and the the integral of error term, z_k which ensures the Type 1 servomechanism performance, i.e.,

$$\mathbf{x}_k = [y_k \quad y_{k-1} \quad \dots \quad y_{k-n+1} \quad u_{k-1} \quad u_{k-2} \quad \dots \quad u_{k-m+1} \quad z_k]^T \quad (14)$$

and z_k is given as:

$$z_k = z_{k-1} + y_{d,k} - y_k \quad (15)$$

where $y_{d,k}$ is the desired command signal. Thus, the SVF control law associated with the NMSS representation takes the form:

$$u_k = -K^T x_k \quad (16)$$

for which the SVF gain vector, K and x_k are each of length $n + m$. To determine K , one method is to use the optimal SVF for which the LQ performance index is minimized.

$$J = \sum_{k=0}^{\infty} \mathbf{x}_k^T \mathbf{Q} \mathbf{x}_k + r(u_k^2) \quad (17)$$

Equation (17) is referred to as the infinite time, optimal LQ servomechanism cost function for a SISO system. Q is a $(n + m)$ by $(n + m)$ symmetric positive semi-definite weighting matrix, whose diagonal elements weigh the sum of squares of the elements of x_k , r is a positive scalar weighting on the control, u_k . Thus, if q_y represent the weight on any output state, q_u is the weight on any input state and q_e is the integral of error state, then

$$Q = \text{diag}(q_y \quad \dots \quad q_y \quad q_u \quad \dots \quad q_u \quad q_e) \quad (18)$$

given that W_y , W_u and W_e represent the total weightings on the output, input and integral-of-error variables, respectively, then the following can be written

$$q_y = \frac{W_y}{n}; q_u = \frac{W_u}{m}; q_e = W_e \quad (19)$$

r is typically set to q_u and $W_y = W_u = W_e = 1$ by default. Given the NMSS system description $\{F, G\}$, Q and r , K^T can be determined by the standard LQ theory as

$$K^T = (r + g^T P g)^{-1} g^T P F \quad (20)$$

where P is the steady-state solution of the following discrete-time Riccati equation

$$P - F^T P F + F^T P g (r + g^T P g)^{-1} g^T P F - Q = 0 \quad (21)$$

To avoid singularity of F , the SVF gains are solved recursively (see Taylor et al. (2013)).

4. SIMULATION RESULTS

Here, the proposed SDP model and optimal PIP control described in the previous sections are evaluated in simulation studies on a highly nonlinear UCSB pH neutralization process.

4.1 The pH Neutralization Process

The schematic diagram of the considered pH neutralization process is shown in Fig. 2, in which NaOH (a strong base), HNO₃ (a strong acid) and NaHCO₃ (a buffer solution) are mixed in a continuously stirred tank. The base stream (u_1), buffer stream (u_2) and acid stream (u_3) are inputs to the system, while the output (y) is the pH of the effluent solution. The level of the tank (h) and the pH are measured variables. The objective here is to control the pH by manipulating the base flow rate in the face of realistic, unmeasured buffer flow rate disturbances. The acid flow rate is assumed to be constant. The dynamic model of the pH neutralization process, derived based on conservation laws and equilibrium relations (for detailed derivation and description, see Hall and Seborg (1989); Hall (1987)) exhibits a severe nonlinearity due to the implicit titration curve equation given in (25). The dynamic model of the reaction invariants (W_a, W_b) and the tank level (h) is presented in state space form as

$$\dot{x} = f(x) + g(x)u_1 + p(x)u_2; \quad z(x, y) = 0 \quad (22)$$

where

$$x \stackrel{\text{def}}{=} [x_1, x_2, x_3]^T = [W_a, W_b, h]^T \quad (23)$$

$$f(x) = \begin{bmatrix} \frac{u_3(W_{a1} - x_1)}{Ax_3} & \frac{u_3(W_{b1} - x_2)}{Ax_3} & \frac{u_3 - q_o}{A} \end{bmatrix}^T$$

$$g(x) = \begin{bmatrix} \frac{(W_{a3} - x_1)}{Ax_3} & \frac{(W_{b3} - x_2)}{Ax_3} & \frac{1}{A} \end{bmatrix}^T \quad (24)$$

$$p(x) = \begin{bmatrix} \frac{(W_{a2} - x_1)}{Ax_3} & \frac{(W_{b2} - x_2)}{Ax_3} & \frac{1}{A} \end{bmatrix}^T$$

and the titration curve equation is

$$z(x, y) = x_1 + 10^{y-14} - 10^{-y} + x_2 \frac{1 + 2 \times 10^{y-pk_2}}{1 + 10^{pk_1-y} + 10^{y-pk_2}} \quad (25)$$

where pk_1 and pk_2 are the first and second dissociation constants of the weak acid H₂CO₃, respectively. The nominal operating conditions of the system are presented in Table. 1.

4.2 Preliminary Step Test

To determine the dominant process dynamics, a series of step tests are first carried out on the pH neutralization

Table 1. Nominal operating conditions for the pH process

$u_1 = 15.55\text{ml/s}$	$W_{a3} = 3.05 \times 10^{-3}\text{mol}$
$u_2 = 0.55\text{ml/s}$	$W_{b1} = 0\text{mol}$
$u_3 = 16.60\text{ml/s}$	$W_{b2} = 0.03\text{mol}$
$q_o = 32.8\text{ml/s}$	$W_{b3} = 5 \times 10^{-5}\text{mol}$
$y = 7$	$pk_1 = 6.35$
$h = 14\text{cm}$	$pk_2 = 10.25$
$A = 207\text{cm}^2$	$W_a = -4.32 \times 10^{-4}\text{mol}$
$W_{a1} = 3 \times 10^{-3}\text{mol}$	$W_b = 5.28 \times 10^{-4}\text{mol}$
$W_{a2} = -0.03\text{mol}$	

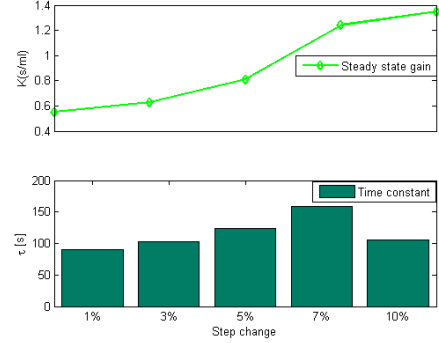

Fig. 3. Step response summary showing gain changes (upper plot) and process time constants (lower plot)

dynamic model in (22). Here, information regarding the (longest) settling time and process nonlinearity, which are needful to design input excitation signal for model identification, are obtained. Step tests of different sizes in the range of 1-10% of the nominal base flow rate (15.55ml/s) are investigated. Fig. 3 shows that the pH process exhibits different time constants in the considered step range with a monotonic increase in steady-state gain as a result of process nonlinearity. The dominant dynamics corresponds to the largest time constant which is approximately 158 s at 7% step size.

4.3 Plant Discretization

To facilitate straightforward implementation on a digital computer, (22) is discretized using the Euler backward difference algorithm. Since the accuracy of a discrete time model is highly dependent on sampling time, t_s which has a direct impact on the model based controller, hence, a suitable value is selected by experimenting with different values to obtain a satisfactory controller performance. Thus, $t_s = 1$ is found appropriate for this purpose. Discretization of (22) gives

$$\dot{x}_k = x_{k-1} + t_s [f(x_{k-1}) + g(x_{k-1})u_{1,k-1} + p(x_{k-1})u_{2,k-1}] \quad (26)$$

To obtain the discretized pH dynamics, the total differential, dz of (25) is obtained, and the result is divided through by dt to have

$$\frac{dz}{dt} = \frac{\partial z}{\partial x} \frac{dx}{dt} + \frac{\partial z}{\partial y} \frac{dy}{dt} = 0 \quad (27)$$

Rearranging (27) and solving for $\frac{dy}{dt}$ using the definition for \dot{x} in (22) and subsequently applying the Euler backward algorithm gives the pH dynamic equation in discrete form

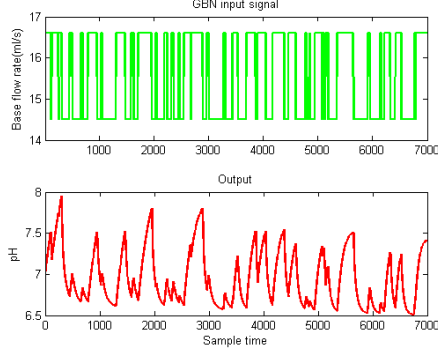

Fig. 4. Input-output identification data set

$$y_k = y_{k-1} - t_s z_y^{-1}(x_{k-1}, y_{k-1}) z_x(y_{k-1}) \times [f(x_{k-1}) + g(x_{k-1})u_{1,k-1} + p(x_{k-1})u_{2,k-1}] \quad (28)$$

where $z_x = \frac{\partial z}{\partial x}$ and $z_y = \frac{\partial z}{\partial y}$ are defined as

$$z_x = \begin{bmatrix} 1 & \frac{1 + 2 \times 10^{y-pk_2}}{1 + 10^{pk_1-y} + 10^{y-pk_2}} & 0 \end{bmatrix}^T \quad (29)$$

$$z_y = \ln 10 (10^{y-14} + 10^{-y}) + x_2 \ln 10 \frac{10^{pk_1-y} + 10^{y-pk_2} + 4(10^{pk_1-y})(y - pk_2)}{(1 + 10^{pk_1-y} + 10^{y-pk_2})^2} \quad (30)$$

4.4 Bilinear Identification

An interesting feature of the bilinear model is that, being linear-like in structure, a straightforward deployment of linear control tools is readily applicable. Thus, a first order bilinear model with one sample delay, as shown in (31), is identified as a compromise between compactness and fitness. This is obtained by setting $n = m = 1$ and $d = \eta_{0,1} = 0$ in (1), and the subscripts on the model parameters are removed for convenience.

$$y_k = -ay_{k-1} + bu_{k-1} + \eta u_{k-1} y_{k-1} + e_k \quad (31)$$

where e_k is a zero mean white Gaussian noise with standard deviation of 0.001. e_k is added to the system output in order to simulate a more realistic situation of when measurement noise is present. The model parameters a , b and η are estimated from identification data set using Kalman filter configured for Parameter Estimation (KFPE). A GBN signal about the nominal value of the base flow rate (15.55ml/s) is used as the exciting signal for identification of (31). GBN signal has been tested industrially and found very effective for linear identification (Zhu, 2001). Here, bilinear identification is carried out around $\pm 7\%$ of the base flow rate and the mean switching time, T_{switch} is given by Zhu (2001) as:

$$T_{switch} = \frac{0.98T_{set}}{3} \quad (32)$$

where T_{set} is the longest settling time of the process obtained from open-loop step experiment. Based on the 7% step response, $T_{set} = 266$ s. The discrete time nonlinear models in (26) and (28) are used to generate input-output data, where the output is composed of 7000 samples and is gathered with 1 s sampling time. The first 5500 samples are used for identification, while the latter 1500 samples are used for model validation. During the data acquisition phase, u_2 and u_3 are kept at their nominal values (see

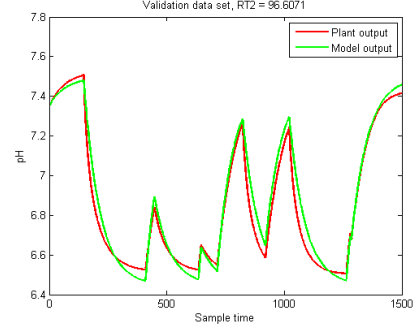

Fig. 5. Validation result of the identified bilinear model

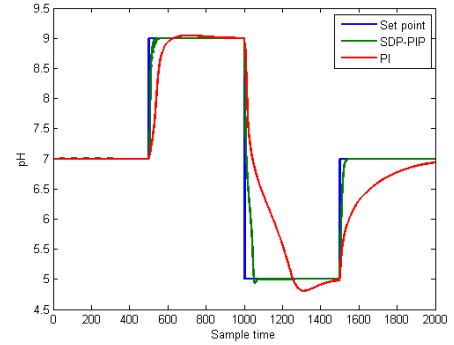

Fig. 6. Servo performances of PI and the proposed SDP-PIP controllers

Table 1). Fig. 5 shows the validation result of the identified bilinear model. The bilinear model is able to capture the process dynamics with coefficient of determination, R_T^2 of 96.6%.

Table 2. Standard buffer flow rate disturbances (Henson and Seborg, 1994)

Sample time (k)	u_2 (ml/s)
1	0.55
200	1.2
600	2
1000	1
1400	0
1800	0.55

4.5 SDP-PIP Control Design

The identified model in (31) is written in the form of SDP model 2, and a quasi-linearised first-order transfer function model is subsequently written as $y_k = \frac{\tilde{b}z^{-1}}{1+az^{-1}}u_k$, where \tilde{b} has already been defined in Section 2. This model is then used in the optimal PIP scheme introduced in Section 3. The incremental form of the PIP control law, $\Delta u_k = -K^T \Delta x_k$ (Taylor et al., 1998b) is used to handle integral wind-up issues when the controller is subject to constraints on the manipulated variable. The manipulated variable, u_k is constrained between the lower limit of 0 ml/s and upper limit of 30 ml/s. Controller tuning parameters $q_y=1$, $q_e=9$ and $r=1$ give satisfactory results.

4.6 PI Control Design

For benchmark purposes, a discrete PI controller is designed and result is compared with those from SDP-PIP

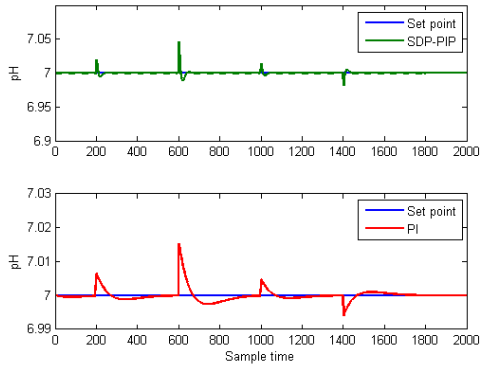

Fig. 7. Regulatory performances of PI and the proposed SDP-PIP controllers

controller.

Based on the 7% step response illustrated in Section 4.2, a First-Order-Plus-Time-Delay (FOPTD) model is first identified using the method of Sundaresan and Krishnaswamy (1978), which is given as:

$$G(s) = \frac{1.24}{112.3s + 1} e^{-34.9s} \quad (33)$$

From (33), the PI controller parameters based on Cohen-Coon tuning are $K_c=2.4$ and $\tau_I=70.95$ s. Subsequent discretization with $t_s=1$ s gives the incremental PI controller as:

$$u_k = u_{k-1} + 2.42e_k - 2.38e_{k-1} \quad (34)$$

The set point tracking performances of the controllers is shown in Fig. 6. The first set point change is well tracked by both controllers, however, the PI controller gives very sluggish pH responses to the second and third changes, while SDP-PIP controller maintains a consistent rapid response and improved set point tracking for all changes. Also, the PI controller response is very sluggish as shown in the lower plot of Fig. 7. However, an improved response is obtained for the proposed SDP-PIP controller as it significantly rejects disturbances as shown in the upper plot of Fig. 7. It is worthy of note that, increasing the magnitude of disturbance increases the pH deviation from set point, however, an inconsistency is observed at the 1401th sample ($u_2=0$ ml/s) with a slightly higher deviation than at the 1001th sample ($u_2=1$ ml/s). This is attributed to the larger process gain in this region. More so, the asymmetrical set point responses, most significant with the PI controller, is due to the variation in process gains in the different set point regions.

5. CONCLUSIONS

In this work, an optimal PIP controller based on SDP bilinear model is proposed to control a highly nonlinear pH neutralization process. Firstly, a discrete time first-order bilinear model is identified using KFPE algorithm to estimate its parameters, followed by the coalition of the bilinear coefficient, η in the b parameter using SDP model 2. A quasi-linearised transfer function model is then written from the SDP bilinear model and from which, SDP-PIP controller is designed and tuned straightforwardly using the weights in the LQ cost function to shape the closed-loop response. To measure the effectiveness of the control

design, a digital PI controller is designed and compared to SDP-PIP controller. Simulation results show the inability of the PI controller to cope with the nonlinearity and time-varying characteristics of the pH process. However, SDP-PIP provides a superior servo and regulatory performances for all operating conditions.

ACKNOWLEDGEMENT

The authors are grateful to Dr. Malgorzata Sumislawska, Dr. Ivan Zajic and Dr. James Whidborne for their contributions.

REFERENCES

- Böling, J.M., Seborg, D.E., and Hespanha, J.P. (2005). Multi-model control of a simulated pH neutralization process. *IFAC Proceedings Volumes*, 38(1), 591–596.
- Burnham, K.J. and Larkowski, T. (2011). Self-tuning and adaptive control. *WUT, Wroclaw, Poland*.
- Friedland, B. (1986). *Control system design: an introduction to state-space methods*, volume 513. Dover Publications, INC. Mineola, New York, USA.
- Gustafsson, T.K. and Waller, K.V. (1983). Dynamic modeling and reaction invariant control of pH. *Chemical Engineering Science*, 38(3), 389–398.
- Hall, R.C. (1987). *Development of a multivariable pH experiment*. M.sc. thesis, University of California, Santa Barbara, USA.
- Hall, R.C. and Seborg, D.E. (1989). Modelling and self-tuning control of a multivariable pH neutralization process part i: modelling and multiloop control. In *Proceedings of the American Control Conference, Pittsburgh, USA*.
- Henson, M.A. and Seborg, D.E. (1994). Adaptive nonlinear control of a pH neutralization process. *IEEE transactions on control systems technology*, 2(3), 169–182.
- Johnson, A. (1987). The control of fed-batch fermentation processes a survey. *Automatica*, 23(6), 691–705.
- Mahmoodi, S., Poshtan, J., Jahed-Motlagh, M.R., and Montazeri, A. (2009). Nonlinear model predictive control of a pH neutralization process based on Wiener-Laguerre model. *Chemical Engineering Journal*, 146(3), 328–337.
- McCabe, A., Young, P., Chotai, A., and Taylor, C.J. (2000). Proportional-integral-plus (PIP) control of non-linear systems. *Systems Science*, 26(3), 25–46.
- Norris, T., Bailey, B., Lees, M., and Young, P. (1996). Design of a controlled-ventilation open-top chamber for climate change research. *Journal of Agricultural Engineering Research*, 64(4), 279–288.
- Singer, M., George, H., et al. (2012). *What Is pH and Why Do We Care?* UCANR Publications, University of California, Davis, California, USA.
- Skogestad, S. and Postlethwaite, I. (2007). *Multivariable feedback control: analysis and design*, volume 2. Wiley New York, USA.
- Sundaresan, K. and Krishnaswamy, P. (1978). Estimation of time delay time constant parameters in time, frequency, and laplace domains. *The Canadian Journal of Chemical Engineering*, 56(2), 257–262.
- Taylor, C.J., Chotai, A., and Burnham, K.J. (2011). Controllable forms for stabilising pole assignment design of generalised bilinear systems. *Electronics Letters*, 47(7), 437–439.
- Taylor, C.J., Chotai, A., and Young, P.C. (1998a). Proportional-integral-plus (PIP) control of time delay systems. *Proceedings of the Institution of Mechanical Engineers, Part I: Journal of Systems and Control Engineering*, 212(1), 37–48.
- Taylor, C.J., Chotai, A., and Young, P.C. (2009). Non-linear control by input-output state variable feedback pole assignment. *International Journal of Control*, 82(6), 1029–1044.
- Taylor, C.J., McCabe, A., Young, P.C., and Chotai, A. (2000). Proportional-integral-plus (PIP) control of the alstom gasifier problem. *Proceedings of the Institution of Mechanical Engineers, Part I: Journal of Systems and Control Engineering*, 214(6), 469–481.
- Taylor, C.J., Young, P.C., and Chotai, A. (2013). *True digital control: statistical modelling and non-minimal state space design*. John Wiley & Sons, UK.
- Taylor, C.J., Young, P.C., Chotai, A., and Whittaker, J. (1998b). Nonminimal state space approach to multivariable ramp metering control of motorway bottlenecks. *IEE Proceedings-Control Theory and Applications*, 145(6), 568–574.
- Young, P. (1996). A general approach to identification, estimation and control for a class of nonlinear dynamic systems. *Identification in engineering systems*, 436–445.
- Young, P., Lees, M., Chotai, A., Tych, W., and Chalabi, Z. (1994). Modelling and PIP control of a glasshouse micro-climate. *Control Engineering Practice*, 2(4), 591–604.
- Young, P., Behzadi, M., Wang, C., and Chotai, A. (1987). Direct digital and adaptive control by input-output state variable feedback pole assignment. *International Journal of Control*, 46(6), 1867–1881.
- Zhou, K. and Doyle, J.C. (1998). *Essentials of robust control*, volume 104. Prentice hall, Upper Saddle River, NJ.
- Zhu, Y. (2001). *Multivariable system identification for process control*, volume 372. Elsevier Science Inc.

2018-01-11

Optimal PIP control of a pH neutralization process based on state-dependent parameter model

Ogun, Oluwaseyi A.

Elsevier

Ogun OA, Festus MU, Inyang IJ. (2017) Optimal PIP control of a pH neutralization process based on state-dependent parameter model, IFAC-PapersOnLine, Volume 50, Issue 2, December 2017, pp. 37-42

<https://doi.org/10.1016/j.ifacol.2017.12.007>

Downloaded from Cranfield Library Services E-Repository