

Use of COTS Functional Analysis Software as an IVHM Design Tool for Detection and Isolation of UAV Fuel System Faults

Octavian Niculita¹, Phil Irving², and Ian K Jennions³

^{1,2,3} *Integrated Vehicle Health Management Centre, Cranfield University, Cranfield, Bedford MK43 0FQ, UK*

o.niculita@cranfield.ac.uk

p.e.irving@cranfield.ac.uk

i.jennions@cranfield.ac.uk

ABSTRACT

This paper presents a new approach to the development of health management solutions which can be applied to both new and legacy platforms during the conceptual design phase. The approach involves the qualitative functional modelling of a system in order to perform an Integrated Vehicle Health Management (IVHM) design – the placement of sensors and the diagnostic rules to be used in interrogating their output. The qualitative functional analysis was chosen as a route for early assessment of failures in complex systems. Functional models of system components are required for capturing the available system knowledge used during various stages of system and IVHM design. MADe™ (Maintenance Aware Design environment), a COTS software tool developed by PHM Technology, was used for the health management design. A model has been built incorporating the failure diagrams of five failure modes for five different components of a UAV fuel system. Thus an inherent health management solution for the system and the optimised sensor set solution have been defined. The automatically generated sensor set solution also contains a diagnostic rule set, which was validated on the fuel rig for different operation modes taking into account the predicted fault detection/isolation and ambiguity group coefficients. It was concluded that when using functional modelling, the IVHM design and the actual system design cannot be done in isolation. The functional approach requires permanent input from the system designer and reliability engineers in order to construct a functional model that will qualitatively represent the real system. In other words, the physical insight should not be isolated from the failure phenomena and the diagnostic analysis tools should be able to adequately capture the experience bases. This approach has been verified on a laboratory bench top

test rig which can simulate a range of possible fuel system faults. The rig is fully instrumented in order to allow benchmarking of various sensing solution for fault detection/isolation that were identified using functional analysis.

1. INTRODUCTION

Initial research on development of IVHM solutions focused on fault identification during operations and maintenance. This research direction culminated with the development of model-based reasoning software tools capable of comparing the observed behaviour with the expected behaviour of the system in order to identify abnormal conditions and eventually performing run-time repairs. Livingstone and its extension L2, HyDe from NASA, Rodon™ from Combitech (2012), TFPG FACT, ReasonPro™ (2012) from Impact Technologies are just a few COTS and open source model-based reasoners that use system configuration and qualitative or quantitative behavioural models for developing fault detection/isolation procedures. A second research direction in developing IVHM solutions is supported by design analysis. These types of analysis are typically carried out for either investigations regarding system's potential to realize the health management goals – as a system design aid. Many different software tools like eXpress™ from DSI Int. (DSI, 2012), TEAMST™ from Qualtech Systems Inc. (QSI, 2012), ADVISE, Design PHM™ from Impact Technologies have been developed to aid the design of IVHM solutions, to minimize diagnostic ambiguity and to optimize diagnostic tests for sensitivity and accuracy (Keller, Baldwinm Ofsthun, Swearingen, Vian, Wilmering & Williams 2007). The reasoning and testability tools can be utilized during the Detailed Design phase of a system.

Octavian Niculita et al. This is an open-access article distributed under the terms of the Creative Commons Attribution 3.0 United States License, which permits unrestricted use, distribution, and reproduction in any medium, provided the original author and source are credited.

The first response in the research community to shift the assessment of failures and associated risks into the Preliminary Design phase focused on employing safety and

reliability analysis. System safety analyses typically include Fault Tree analysis, Event Tree analysis, and Probabilistic Risk Assessments. The most common of these is the Fault Tree Analysis (FTA), which is constructed to perform a Functional Hazard Assessment (FHA). In an FHA, safety engineers identify unacceptable design features and propose design or usage changes that will mitigate the failure effects and satisfy safety requirements. FTA identifies system high-level failures that could result in loss of life or costly system equipment. For each of these critical functions, the safety engineer performs a functional analysis of how the system works in normal operating conditions, then determines which failure modes could lead to the occurrence of the critical system functional failure. FTA are characterized by a top-down approach, which starts with the identification of a high-level failure event continued by the revealing of the contributing events that could lead to the occurrence of that high-level event. Software tools supporting the Safety Analysis process include but are not limited to CAFTA™, Fault Tree +™, and Sapphire™. The most frequently types of reliability analysis are carried out using Failure Modes and Effects (Criticality) Analysis and System Reliability Predictions. FMEA/FMECA typically starts with the lowest level hardware (piece-part FMEA/FMECA) or system functions (functional FMEA/FMECA), by determining the fundamental failure modes that have a direct effect on those piece-parts or functions. The next FMEA step is the representation of system functional effects at successive indenture levels of the system. A FMECA adds the notion of failure criticality to a FMEA. The failure rates of the associated failures are often taken into consideration. Software tools supporting the Reliability Analysis process include but are not limited to OCAS™, Isograph™, Relex™.

Over the last decade, industry and academia have tried to integrate conceptual system design and diagnostic design into a common platform, in order to improve the overall system performance and availability (Brignolo, Cascio, Console, Dague, Dubois, Dressler, Millet, Rehfus & Struss 2001; Kurtoglu, Johnson, Barszczm Johnson, & Robinson 2008; Glover, Cross, Lucas, Stecki, and Stecki, 2010). A necessary condition for creating this platform is the adoption of a recognised common ontology (Wilmering, 2008). Wilmering highlighted that the two main challenges in the development of this ontology:

- Information re - use;
- Integration of the tools.

Each manufacturer of complex systems seems to have developed their own methods and apparatus for integration of system engineering, testability, diagnosability and reasoning tools.

Since most of the IVHM related research focuses on fault detection and isolation during system operation and system maintenance, approaching the IVHM design stage is still in

its early beginnings (Walker & Kapadia, 2010). Existing tools use different techniques and methods for system representation and diagnostic development and have a wide range of capabilities and performance. There is still the need to develop reliable benchmarks to quantitatively assess tool performance and effectiveness. The Diagnostic Competition defined by NASA Ames Research Centre is a good example of how to find the best diagnostic solution among tools generally used during the Detailed Design phase (Kurtoglu, Narasimhan, Poll, Garcia, Kuhn, de Kleer, van Gemund, & Feldman, 2009). Our research is trying to complement the above mentioned research, by evaluating various COTS software tools capable of integrating IVHM development process into Conceptual Design of a high-tech high-value system.

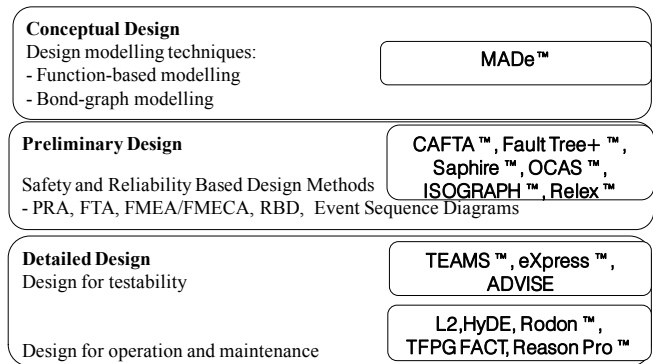

Figure 1. COTS IVHM Design software tools

This paper focuses on the use of functional analysis for the development of IVHM solutions. This type of analysis enables the integration of system failures analysis (traditionally carried out during the Preliminary Design phase through safety and reliability analysis) into the Conceptual Design phase for a new system. This approach allows for a better understanding of the failure mechanism, for a more precise identification of fault propagation paths throughout the system, and for a better system design against the faults that might arise once the system is deployed into operations.

When developing a reliable functional model for a complex system it is necessary to have access to a rigorously defined taxonomy. The origins of the functional approach used in design dates back to the mid '80s (Hubka, V. & Ernst Eder, W., 1984) (Pahl, G. & Beitz, W., 1988) and it is attributed to the European schools of design as identified by Stone & Wood (2000) and Malin, & Throop (2007). Pahl states that the quality of a system has to be built-in from the beginning of the design process and maintained throughout the whole production process. This will insure a high degree of availability, once the system is deployed into its operational environment He goes even further; emphasizing that up to 80% of all system faults can be traced back to insufficient

planning and design work. Assuming this, it can be stipulated that initiating a failure analysis from the conceptual design phase will have a positive impact on the quality of the system being designed. Later on, this approach generated different views (Ulrich & Eppinger, 1995; Ullman, 1997) in the USA. A consistent review of the ontology of functions, entities and problems, relevant to the engineering world and used by FMECA was carried out by Rudov-Clark, Stecki, and Stecki (2009) and it was concluded that the taxonomy built by Stone was the most generic taxonomy, suitable for a wide range of engineering applications, so it was used in supporting the functional analysis inside MADe™. It has been demonstrated in the last decade that functional modelling is a key step in the system conceptual design process, whether original or redesign (Stone & Wood, 2000). Stone's original taxonomy was considerable extended in the last years by exploiting component function-based behavioural modelling as part of the system engineering process (Hutchenson, McAdams, Tumer, 2012). Functional representations can be identified in both domains of software and hardware safety and reliability. The many forms of system safety and reliability analysis such as Fault Tree, Event Tree, FMECAs and Probabilistic Risk Assessments are important stages during system development as part of the Preliminary Design stage. The main drawback of these methods is that they cannot be applied at the Conceptual Design stage, since at this point models are not fully documented, the knowledge repository is not available, and accurate probability numbers are not defined with confidence. The function based design paradigm was further explored by Tumer, as part of the research focused on failure analysis of complex systems. She emphasized the integration of failure analysis for software driven hardware systems into the Conceptual Design stage (Tumer & Smidts, 2011). Kurtoglu and Tumer's research formed the baseline for the creation of a unified functional fault identification and propagation framework as part of early design stage of a new generation of high tech high value systems (Kurtoglu & Tumer, 2008).

The use of system functional analysis as part of the system design can enhance the confidence of safety analysis at the early stages and aid throughout the development of system health management capability. Health management design is generally undertaken in order to support fault detection strategies, fault isolation strategies and design of testability solutions. Fault detection analysis calculates the percentage of system faults that can be detected by defined tests. Fault isolation analysis determines the failure ambiguity groups that will result from exercising the defined tests over the fault universe. Testability analysis sometimes associated with sensor set definition and optimization will determine the optimal sequence of tests to be implemented based on the fault space, defined tests, and other optimization criteria (practicality, cost, weight, reliability). As designs become more complex, defining and implementing a testability

solution becomes more challenging. Ideally, health management capability must be developed concurrent with the design itself. Current practice does not facilitate an automatic feedback loop between test engineers and system design engineers. This feedback can be achieved through the incorporation of health management development process in the early design stage of the asset.

The functional modelling approach uses functions and flows to describe the system. Clear ontology should be provided with each functional model in order to ensure others can read it, as they might represent a blueprint of the system using a different ontology.

MADe™ software tool was selected for being the only COTS software that employs functional analysis as a method to design IVHM solution during the Conceptual Design phase of a new asset. The software provides a clear ontology, which can be used simultaneously by system designers, reliability-availability-maintainability engineers and IVHM designers in modelling the real asset and running specific type of analysis for each individual field. Another reason behind the selection of this package is the built-in connection between functional modelling and behavioural modelling within the same model. This connection allows for a fast and robust identification of the fault propagation paths throughout the system. Additional reasons behind the selection of this tool were the early validation and reusability of models, its ability to model systems/sub-systems/components/parts and the automated support for safety/reliability analysis.

This paper is the first of a series which highlights the pros and cons of existing COTS software tools employed during the health management development process. The objectives of this particular research are to establish the capability and utility of the MADe implementation of functional analysis in conceptual design of a health monitoring system for a laboratory based fuel system typical of that found on UAV aircraft. The items considered are: i) development of the fuel system functional and behavioural model ii) sensor set optimization for identification of selected faults and iii) challenges encountered throughout the implementation of the health management solution.

This paper contributes to the transformation of state of the art software tools into state of practice by identifying the advantages and shortcomings in building a functional model to aid the development and integration of IVHM Design into the Conceptual Design phase of a complex system.

2. FUEL SYSTEM TEST BED

Integrated systems such as those supplying fuel to aircraft engines are evolving to higher complexity with each generation and their faults are consequently becoming more

difficult to diagnose. On the other hand, the demands for extreme reliability imposed by the regulators and maximized availability imposed by the operators are continuously increasing.

We aim to take a relative simple fuel system, to illustrate the key steps of the diagnostic analysis using functional analysis and to implement the output of this analysis within an IVHM solution which meets the initial fault detection and isolation requirements. A schematic diagram of the fuel system is presented in Figure 2a. The fuel system contains a motor driven external gear pump with internal relief valve, a shut off valve, one filter, two tanks (main tank and sump tank, the last one emulating the engine), non-return valve, three-way valve to switch between recirculation and engine-feed mode, variable restrictor to simulate engine injection and back pressure when partially closed. The fuel system is representative of a small UAV engine feed. The diagnostic analysis will focus on the filter, pump, shut-off valve, pipes and nozzle failure modes. Five failure modes that are emulated on the rig are: filter clogging from foreign matter, pump degradation, valve stuck in a midrange position, leak in the main line, and a clogged nozzle.

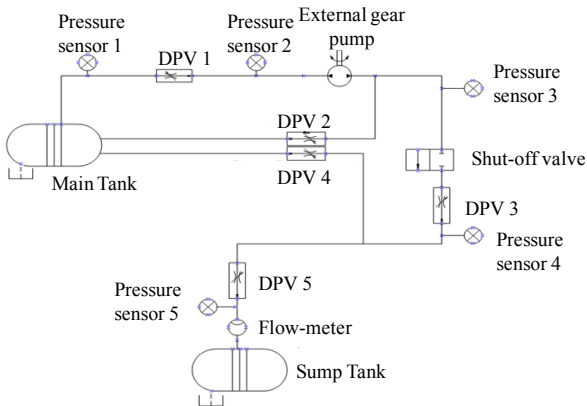

Figure 2a. Fuel system schematic

The fuel rig can accommodate various faults with different degrees of severity. When a filter clogs, the flow through the filter reduces and the pressure difference measured across the filter increases. The filter failure was emulated by replacing the filter component with a Direct-acting Proportional Valve (DPV1). Valve position fully open is equivalent to a healthy filter; partially closed being equivalent to a clogged filter with a particular degree of severity. Various degrees of severity of this fault can be simulated by varying the DPV position. In this manner, incipient, slow progression, cascading and abrupt types of faults can be simulated on the rig and the ability of the functional approach to model and address such conditions can be assessed. The physical implementation of the fuel system test bed is depicted in Figure 2b.

The physical system allows the testing and validation of various IVHM models and the assessment of the analyses

carried out using such models. Prior the construction of the physical system, a physical simulation model was developed during the fuel system design phase using a CAE COTS software tool: SimulationX™ from ITI. This modelling phase encompasses basically the sensibility studies carried out during the fuel system design phase in order to specify in a correct manner the components/system performance in order to meet the specified system requirements.

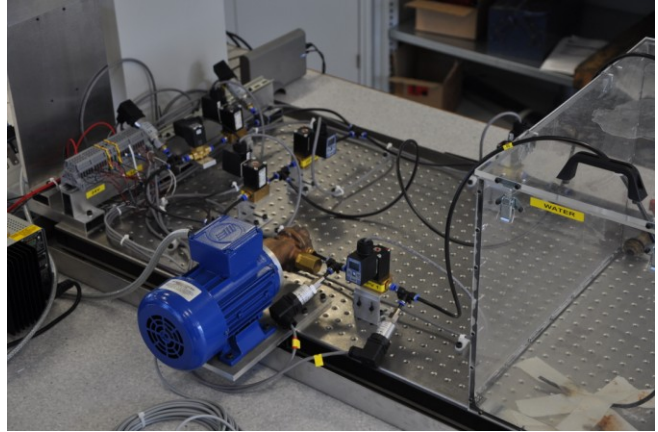

Figure 2b. Fuel system test bed

The fuel system designer is the one who can get the first insights into the system failure world, by using physical simulation models (as fluid-flow SimulationX™ model) to recreate various faulty scenarios. This knowledge should be incorporated into the diagnostic analysis models in order to ensure the consistency and accuracy of such models. The novelty of this work resides in the ability of simultaneously simulating various fuel system faults on the real system, in a simulation environment and in a functional model. The next section will describe the development of a functional model capable of aiding the development of the fuel system IVHM capability.

3. MADE FUNCTIONAL MODELLING FRAMEWORK APPLIED TO THE FUEL SYSTEM

Functional modelling makes use of a system model which decomposes the main system function(s) into smaller functions which are well defined for each component. This enables the assessment of the correct functionality of the system. The taxonomy used by this software package has nine major classes of functions, presented in Table 1. Each class further expands to other functions.

A primary element of any functional modelling approach is the representation of real world information corresponding to the input and output for the previously defined functions. These elements are represented by flows.

Three categories of flows, namely *energy*, *signal* and *material* were employed to capture system's characteristics. Some of the previously defined functions can accept any category of flow but others can deal only with particular

types (e.g. all three functions - to transfer, to transmit, and to transport belong to the same functional class - to channel, but, the *transfer* function accepts all type of flows; the *transmit* deals with energy or signal types of flow, while the *transport* can be used only in conjunction with material flow). Energy flows are depicted with red, signals with blue and material with green in later diagrams.

For the functional layer to be completed according to the method described in section 3, the links between all components have to be defined. This is achieved by translating the real world information exchange into distinct type of flows and by associating these as inputs and outputs for the functions defined already. These flows represent a measurable characteristic for the function (Kirschman, 1996) and are used during the Preliminary Design phase. The flow related information is mainly useful in supporting Failure Mode, Effects and Criticality Analysis (FMECA), where failures are related to the discrepancy in flow properties.

Class	Description
Branch	To cause a material or energy to no longer be joined or mixed
Channel	To cause a material or energy to move from one location to another
Connect	To bring two materials or energies together
Control	To alter or govern the size or amplitude of material, signal or energy
Convert	To change from one form of material or energy to another
Provide	To accumulate or provide material or energy
Signal	To provide information
Stop	To cease or prevent the transfer of material, signal or energy
Support	To firmly fix a material into a defined location or to secure an energy into a specific course

Table 1: Function classes provided by MADE

Figures 3a and 3b are two snapshots of the fuel system functional model. Figure 3a describes the function of the pump motor: to convert the electric energy and a specific analogue value into mechanical rotational energy. Components can be fully described following this functional approach by a single function (e.g. gear pump motor) or a combination of function (see the shut-off valve functions) as described in Figure 3b.

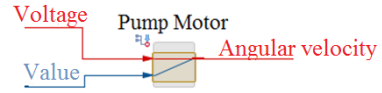

To convert – to change from one form of energy (*electrical energy*) or material to another form of energy (*mechanical – angular velocity*)

Figure 3a. Functional model schematic for gear pump motor component

The gear pump supplies the system with the hydraulic energy necessary to provide the flow rate and to transfer the potential contamination down the line.

The pipe between the pump and the shut-off valve *transmits* the hydraulic energy received from the pump while the shut-off valve has a suite of two different functions as follows: *to channel* the hydraulic energy down the line in the next pipe and *to regulate* the hydraulic energy in response to the information received from the solenoid. Both components (the pipe and the shut-off valve) have an extra function: *to transport* the potential contamination in the system, if such type of analysis is to be taken into consideration.

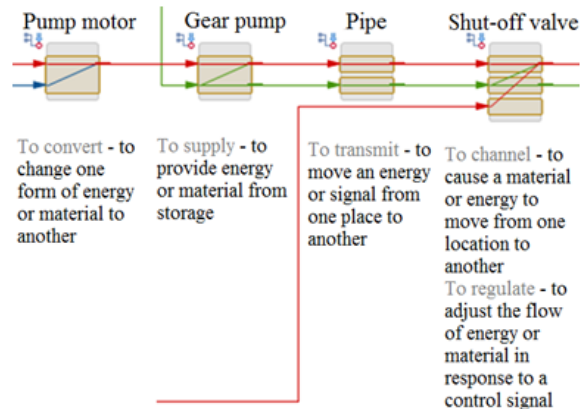

Figure 3b. Functional model schematic for gear pump motor, gear pump, pipe and shut-off valve components

Within a functional model, the inputs and output are connected inside each component by a causal link. The model can capture the polarity of these causal links depending on the effect of the input on the output (Figure 4a-Figure 4d). Each component functional model encapsulates the causality connection between two different types of flow. The pump motor functional model contains a positive connection between the voltage (the input flow presented as electrical energy) and the angular velocity (output flow presented as mechanical rotational energy). The same positive connection is found in the second connection (value-angular velocity).

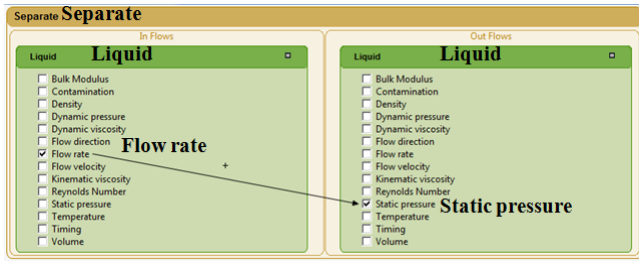

Figure 4a. Causal links between inputs and outputs flows for filter component

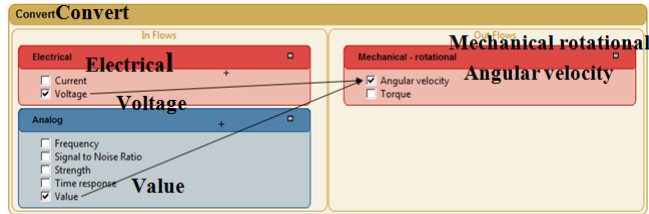

Figure 4b. Causal links between inputs and outputs flows for pump motor component

The function of the pump will be to supply flow rate as hydraulic energy by making use of angular velocity (provided by the motor) and the flow rate (provided by the inlet pipe). In order to obtain a consistent model, the output flows of a component have to match the input flows of the component positioned downstream.

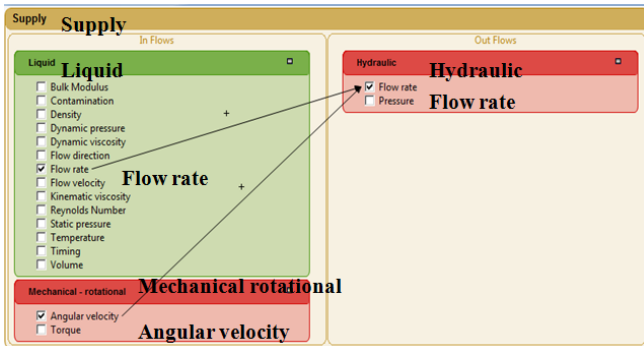

Figure 4c. Causal links between inputs and outputs flows for external gear pump component

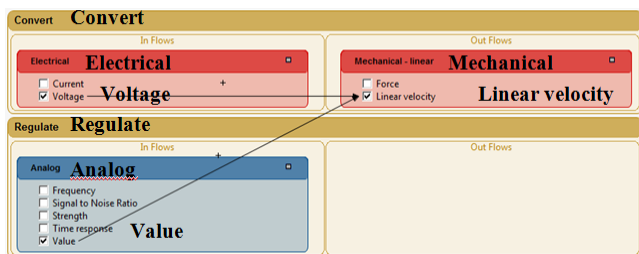

Figure 4d. Causal links between inputs and outputs flows for valve solenoid component

Figure 5 presents the full functional model at the system level and also presents the exchange of information between components using specific types of flow.

The reticence in using this tool is the fact that requires a change in failure addressing approach from physical to functional. Therefore it requires a fully adoption of its functional taxonomy in order to be able to emulate the real system into viable models.

At this point, a functional model can answer the questions related to fault propagations paths throughout the system (Glover, 2010). However some queries still remain about the causes of failures, how a system can fail, how critical each failure is and about the interaction between failures and their impact on the overall system capability. The answers to these questions can be revealed by populating the functional model with failure modes for all components and by focusing the analysis on the most critical or ones likely to be the most frequent. The functional model was populated with failure diagrams for five of the fuel system components: the filter, the gear pump, the shut-off valve, the pipe 04, and the nozzle. Once all the failure modes are defined, the system functional model is considered as being complete.

Our main goal is to design an IVHM solution capable of discriminating between nominal/faulty cases and also capable of isolating all five faults. Since the fault universe is relatively small (five faults) we aim for 100% fault detection and isolation (no ambiguity groups).

Often the failure modes are confused with failure mechanisms or the failure causes. To overcome this, the software under investigation uses a rigid terminology for failure descriptions: these must be characterized by causes, mechanism, faults, and symptoms. These four elements form a low level of abstraction regarding system knowledge, while the functional failure mode is considered to be a high level and will define the basis of the functional analysis. For example: a pipe component can leak or be clogged. These two failure modes are captured by the behavioural taxonomy as shown in Figure 6a.

Causes are linked to mechanisms, which then lead into faults that are ultimately connected to functional failures. Mechanisms and faults can present particular symptoms and these are captured accordingly in the failure diagram. These symptoms are the expression of unintended/emerging behaviour of a faulty system. Figure 6b depicts the functional model of a pump, highlighting the inputs (speed, back pressure, and pump characteristic), the function (*to produce flow*), the intended output (the flow rate response including the normal/abnormal behaviour effects (flow rate OK, too high or too low)), the failure modes and their unintended/emerging behaviour (classified as symptoms). One of the failure modes affecting the pump is represented

through a failure diagram by defining the cause(s), the mechanism(s) and faults that can be linked to the functional failure (of not supplying the required amount of hydraulic energy as volumetric flow rate). Due to the restrictions of the physics for this failure mode, this flow indicator can display either OK or too low, hence the negative causality between the fault concept and the functional failure concept. Three types of failure side effects are captured by linking the symptom concepts to the functional failure diagram previously defined as in Figure 6c.

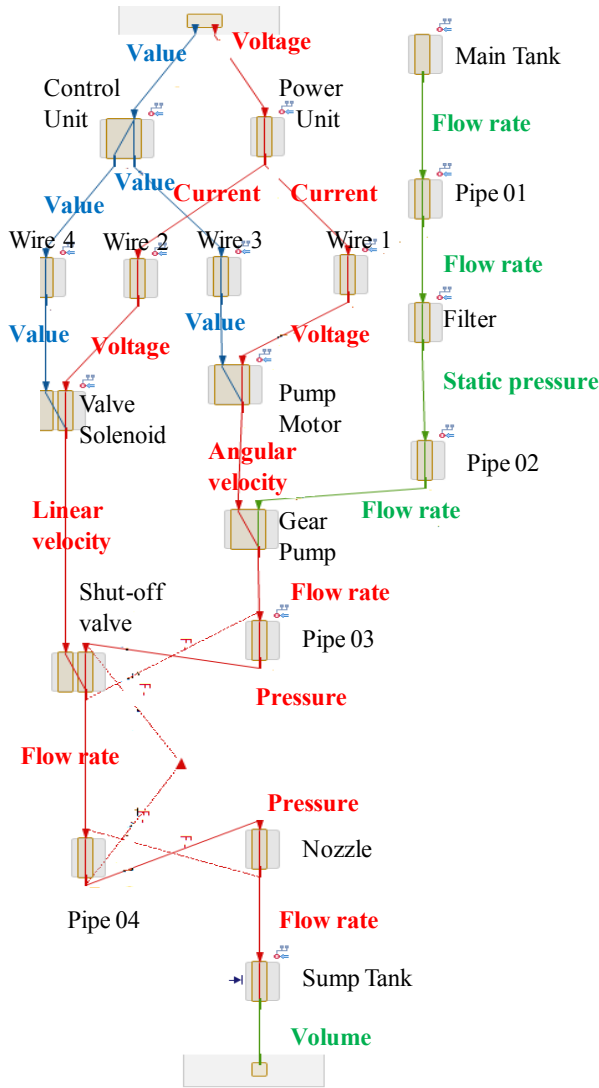

Figure 5. Fuel system functional model

The unintended/emerging behaviours complement the development of the health management solution, as they allow the user to define built-in tests for the components affected by such behaviours in order to obtain a higher probability of detection. These sensing capabilities will work in conjunction to the functional sensing capabilities identified using the functional analysis. Symptom driven

reasoning modules were proved to be extremely useful for discrimination between members of the same ambiguity group.

Causes, mechanisms and faults are all external inputs to the model and do not arise from the intrinsic functional representation of the components. Causes and faults selected for inclusion might be the ones which most frequently occur (based on service experience) or the ones which the safety analysis considers most dangerous.

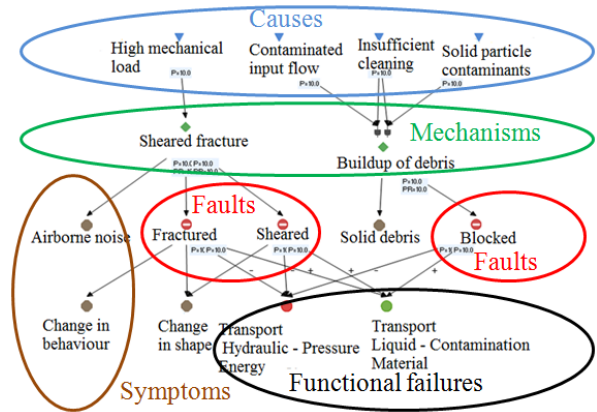

Figure 6a. Failure mode diagram, pipe example

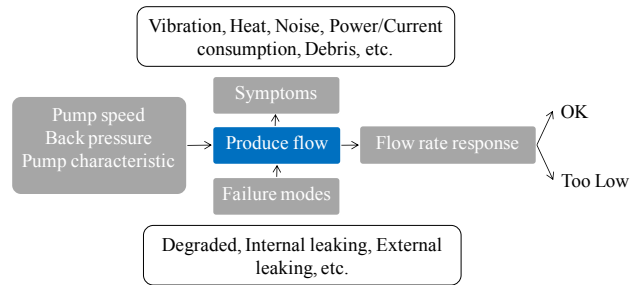

Figure 6b. Pump component, functional model

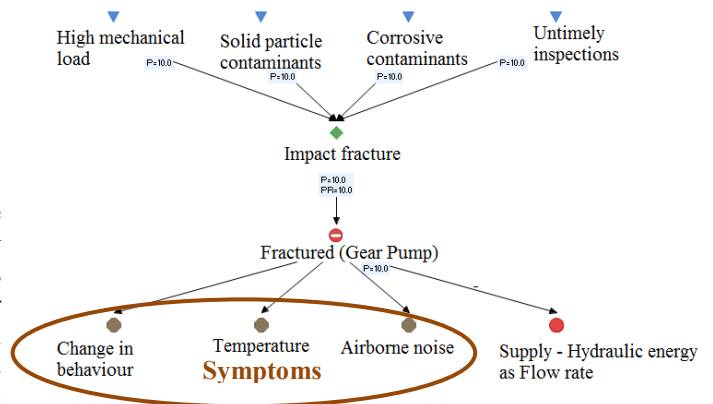

Figure 6c. Pump failure diagram, symptoms capturing

All elements of a failure diagram can be characterized by criticality numbers for difficulty of detection, occurrence, probability, progression rate and severity. We will first consider the functional failure of a pipe of *not being able to transport the hydraulic energy as pressure*. The criticality settings for this functional failure are shown in Figure 7. System Designers, Reliability Availability and Maintainability (RAM) analysts, IVHM designers and logisticians are able to populate the failure diagrams through criticality coefficients using their own experience and information expertise. Variability in detection difficulty can be represented within the functional model by choosing the functional failure to be detectable either during a flight test or a ground inspection or by setting it as a non-detectable type of failure. Occurrence, frequency and severity of a failure may be treated using the same approach. These settings will be directly fed into the calculation of Risk Priority Number (RPN) for each individual fault, enabling the realization of a complete map for safety, reliability, availability and IVHM design analysis. A real advantage of this procedure is the consistency obtained by using the same tool across the entire development process.

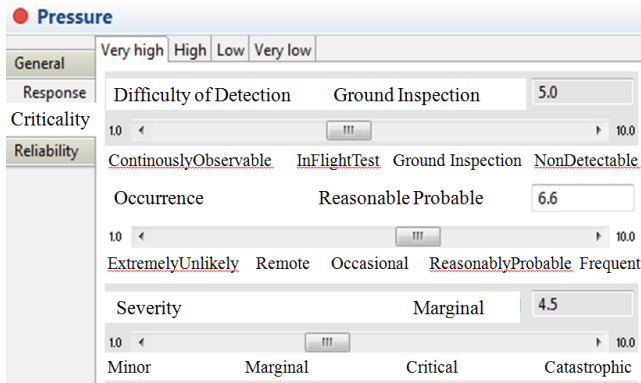

Figure 7. Failure diagram - criticality settings

By accommodating this system knowledge, the model generates a propagation table describing the effect of all failure modes on the system. This operation is undertaken by propagating the erroneous output flow of the components through the software Fuzzy Cognitive Map (FCM) capability. The propagation table represents the baseline for generating the list of the functional failures. Previous research proved that the IVHM design process built on physical failure assessment is highly error prone as it does not take into account the impact of failures on other system components.

The functional model also supports safety and reliability analysis by performing the most common type of analysis: Fault Tree Analysis (FTA) and FMECAs. It is not meant to replace the detailed analysis carried out by dedicated safety

tools like: Isograph™, Relex™, CAFTA™, Sapphire™ or Fault Tree+ but having these features as part of a functional modelling tool enhances the health management development process.

Figure 8 illustrates the fault tree analysis for the fuel system with five faults: clogged filter, faulty gear pump, faulty shut-off valve, leaking pipe, clogged pipe. The five faults were propagated through the model using these failure diagrams in order to determine their end effects. The FTA incorporates a list of failure routes, which describes a sequence of events, eventually leading to a system failure. Figure 8a shows the fault tree display of a cut set with the failure of the filter marked in orange. The top element of the FTA is the function of the overall fuel system – to provide fuel – which in the case of a filter failure would be lost. The cut set represents the route through a fault tree between an event (system failure) and an initiator (component failure mode).

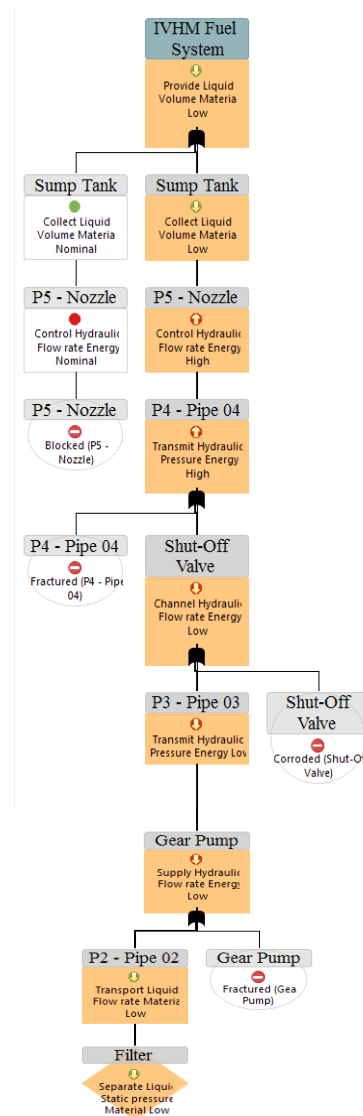

Figure 8a. Fault tree displaying the cut set for filter failure

The FTA is accompanied by the decomposition table of probability of occurrence ($P(f)$) and relative importance of each individual failure mode ($RI\%(F)$) as in Figure 8b.

Each component of the functional model is characterized from the criticality point of view by the duration of operation, mean time to repair and a failure distribution type (exponential or Weibull). A criticality analysis can be carried out by establishing a minimum threshold for criticality indicators or by activating the failure modes only for the components under investigation. The second option was selected for this study. Two types of reliability analyses were carried out using this software: functional reliability and hardware reliability. The results of the hardware reliability calculated using block diagrams are depicted in Figure 8c. Only the components that can be simulated on the test bed as being faulty were characterized through an exponential failure distribution defined by the part failure rate (λ), mean part failure rate ($\lambda \times 10^6$ hours) and standard deviation (failure rate).

Basic Event	P(f)	RI% (F)
IVHM Fuel System		
Filter		
Separate Liquid Static pressure Material Low	0.0001279	1.9
Gear Pump		
Fractured (Gear Pump)	0.0021822	32.4
P4 - Pipe 04		
Fractured (P4 - Pipe 04)	0.0000923	1.4
P5 - Nozzle		
Blocked (P5 - Nozzle)	0.0008919	13.3
Shut-Off Valve		
Corroded (Shut-Off Valve)	0.0035016	52

Figure 8b. FTA results

Within the same module of the software, the reliability analysis results can also be complemented by Monte Carlo simulations.

The functional analysis allows for the automatic identification of the required set of sensors and the associated logic capable of detecting and isolating each fault within the fault universe. In the case of this study, the fault universe is constituted by a clogged filter, a degraded gear pump, a shut-off valve stuck mid range, a leaking pipe and a clogged nozzle.

The sensor identification analysis enables the calculation of Fault Detection and Fault Isolation coefficients with reference to the entire fault universe. Fault Detection analysis calculates the percentage of system faults (defined as specific component failure modes) detected by the proscribed tests. Fault Isolation analysis determines the failure ambiguity groups that will result from exercising the tests over the fault universe.

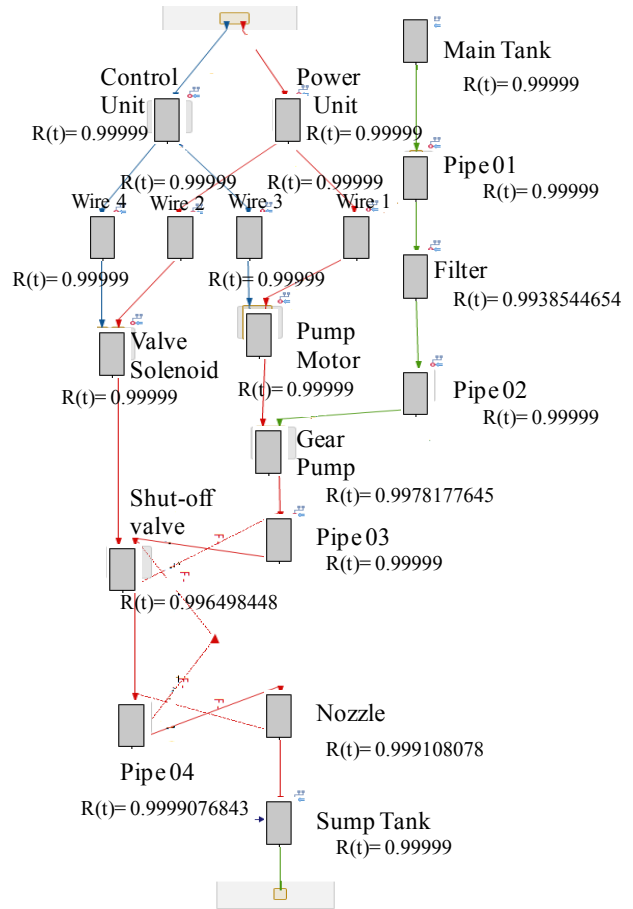

Figure 8c. Fuel system - Hardware reliability

IVHM designers require tools able to run what-if type of analyses in order to identify the optimum health management solution meeting the fault detection and fault isolation requirements. Due to different types of restrictions in terms of weight, costs, performance, probability of detection of the HM solution on one side and sensor reliability on the other side, FDI coefficients might have to be dropped below the required figures. Ambiguity groups - collections of failure modes with the same system response - will appear in such situations. Once sensors have been identified, the diagnostic analysis also provides the core elements for a reasoning capability/expert system. Once a deviation of a particular parameter outside its nominal range is detected, the function of that component will be evaluated by examining high-level functional failure mode layers and the causes, mechanisms, faults and symptoms described in the lower levels of the model.

4. SENSOR SET OPTIMISATION

The fuel system sensor set optimization analysis is based on the functional model developed in the previous section. As

mentioned before, the overall function of the fuel system is to provide a volume of fuel when commanded by an electric signal assuming that it was powered up.

When each of the five faults is injected in the system through its own failure diagrams, the tool will generate a propagation path of the failure. The propagation paths are collated into a propagation table which will form the basis for the sensor set optimization process. Each line from the Table 2 represents the effects of the five failure modes on the output flow(s) of the other components.

The vector (F.G.P.P.P.S.S.) represents the Filter *pressure*, Gear pump *flow rate*, Pipe 02 *flow rate*, Pipe 03 *flow rate*, Pipe 04 *pressure*, Nozzle *flow rate*, Shut-off valve *flow rate*, Sump tank *volume* output parameters. The arrow-up and arrow-down symbols mark the deviation of these parameter outside normal boundaries when a particular failure mode was injected and propagated throughout the functional model.

For example, the first row of Table 2 shows the effects of a clogged filter on the system response. A clogged filter determines the flow rate in pipe 02 to decrease; this will impact the flow rate down the line in the gear pump, pipe 03, pipe 04, shut-off valve and the sump tank.

COMPONENT	FLOW	FAILURE	F	G	P	P	P	P	S	S
FILTER	PRESSURE	LOW	↓	↓	↓	↓	↓	↓	↓	↓
PUMP	FLOW	LOW	↓	↓	↓	↓	↓	↓	↓	↓
PIPE	PRESSURE	LOW	↓	↓	↓	↓	↓	↓	↑	↓
NOZZLE	FLOW	LOW	↑	↓	↑	↑	↑	↓	↓	↓
VALVE	FLOW	LOW	↑	↓	↑	↑	↓	↓	↓	↓

Table 2. Fuel system propagation table obtained using functional analysis

The functional modelling technique (input flows linked to output flows throughout the functional layer) might induce the designer to model only the downstream effects of a particular fault. The Fuzzy Cognitive Maps (FCM) method employed by this tool also allows for modelling of upstream effects. The dotted red line in Figure 9 is the causal connection representing the effect of a clogged nozzle on the upstream component (Pipe 04). If a nozzle is getting clogged, the output parameter (flow rate) decreases. The variation of this flow rate parameter has an inversely proportional effect on the Pipe 04 input flow rate parameter increasing afterwards the output pressure. This behaviour could not have been achieved without the negative feedback loop depicted in Figure 9. The same technique will be replicated upstream using iterative loops throughout the system until all the effects of a clogged nozzle would be captured by the model.

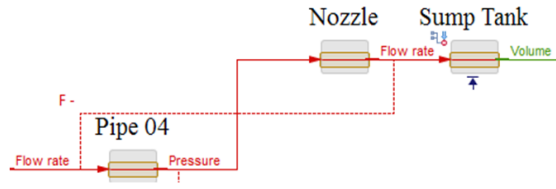

Figure 9. FCM Feedback loops

A functional model will therefore be consistent when the propagation table generated by the model will replicate from a qualitative point of view the physics of the system under similar faulty conditions.

The qualitative characteristics of each individual failure contained in the propagation table are processed by an optimization algorithm in order to identify the combination of elements which allow discriminating between them. The elements mentioned above are in fact the flows captured in the functional analysis and the type of flows will determine the type of sensors to be used to identify a particular fault. A detailed description of the sensor set discrimination analysis using this software is presented by Rudov-Clark (Rudov-Clark, 2009).

Functional analysis is a qualitative analysis. This type of qualitative analysis identifies the foundation of an HM solution for a given system for a known fault universe. As mentioned in the previous section, for this particular scenario of the fuel system, the fault universe is composed by five distinct faults. The optimization algorithm generates 6 sensor set solutions, with maximum coverage and no ambiguity groups. One of the solutions contains four sensors and is presented in Figure 10 and it comprises of:

- S1 - a sensor measuring the *static pressure* after the Filter,
- S2 - a sensor measuring the *flow rate* after the Gear pump,
- S3 - a sensor measuring the *flow rate* after the Shut-off valve
- S4 - a sensor measuring the *pressure* in the Pipe 04.

The components that need to be monitored are marked with green. The type of sensor is determined by the type of the output flow of those components. By making use of the output from these sensors, the analysis shows that it is possible to discriminate with 100% confidence between all five faults by using a particular diagnostic logic. Obviously, this was expected as the structure of the fuel system is quite simple, and there are only five faults.

Based on this analysis, the IVHM designer has information about the location of the sensors contained in each sensor set, and also information regarding the type of the monitored flow. All the sensor set solutions are complemented by fault detection, fault isolation and ambiguity group indicators (if any).

Each sensor set also contains the diagnostic rules to be implemented on the real system to enable the fault

identification. Most of the time, the diagnostic rules are associated with tests that are carried out during the diagnostic and troubleshooting procedures.

Functional models are typically used for either analysis of a system’s potential to realize health management goals – as a design aid - or to support execution of fault isolation reasoning. The output of the functional analysis represents the input to other tools that actually create, or help direct the creation of, executable system diagnostics. The qualitative diagnostic layer produced by MADE will have to be complemented by a quantitative layer obtained by physical simulation of the system flows.

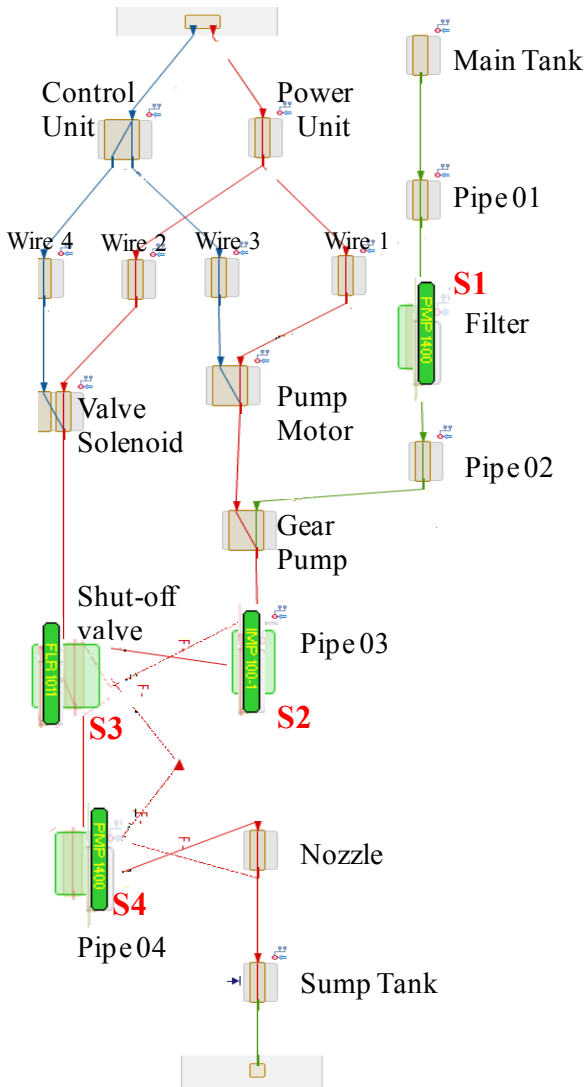
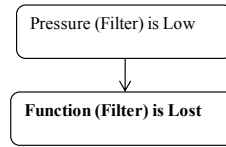

Figure 10. One of the functional sensor set solutions

Figure 11 shows the diagnostic rules associated with the sensor set solution from Figure 10.

Clogged filter:



Degraded gear pump:

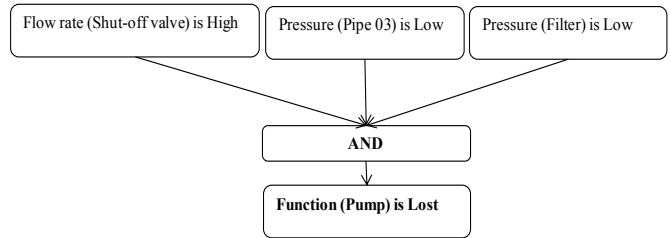

Shut-off valve stuck mid range:

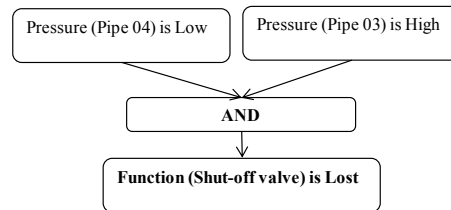

Leaking Pipe:

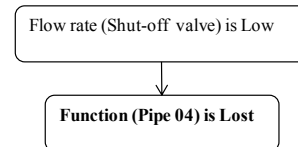

Clogged nozzle:

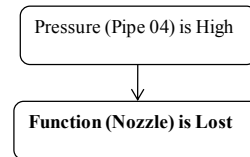

Figure 11. Diagnostic rules for the optimized sensor set solution depicted in Figure 10

These rules form the baseline for diagnostic engine of the fuel system. For example the function of the gear pump (to deliver a specific amount of flow rate) is classified as lost if the sensor monitoring the shut-off valve flow rate has an output value below nominal, the pressure in pipe 03 below nominal and the static pressure at the filter is below

nominal values. In all other cases, the function is considered to be operating normally. In a similar manner, the other four diagnostic rules describe the lost of filter, shut-off valve, pipe and nozzle’s functionality by making use of the output of the sensors (S1-S4).

Information on weight, cost and reliability can be associated with each sensor in order to get a clear image of the comparison between different IVHM solutions (as in Table 3). The software might further generate queries about various sensor set solutions as in Figure 12.

Name	Type	# of Sensors	Coverage	Possible Coverage	Cost	Weight (g)
Sensor Set 1	FCM	4	100%	100%	£910.00	175.00
Sensor Set 2	FCM	4	100%	100%	£1,300.00	100.00
Sensor Set 3	FCM	4	100%	100%	£1,010.00	150.00
Sensor Set 4	FCM	4	100%	100%	£1,200.00	125.00
Sensor Set 5	FCM	4	100%	100%	£500.00	30.00
Sensor Set 6	FCM	4	100%	100%	£1,080.00	115.00

Table 3. Sensor set additional information

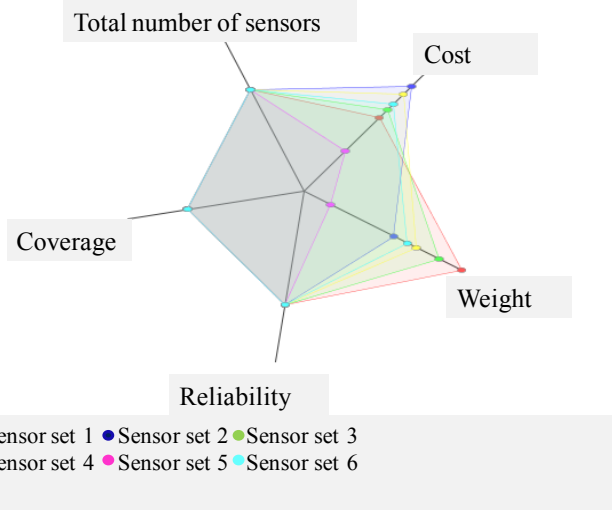

Figure 12. Sensor set comparison query

The information generated by functional analysis can be further used by the HM designer in developing the executable HM solution and also by the system designer in analyzing the impact on the overall design once this solution is integrated with the asset.

5. IVHM SOLUTION – VERIFICATION AND VALIDATION

The sensor set solutions identified and highlighted in the previous section were embedded in the physical test bed and the functional diagnostic rules were assessed against physical simulation results.

For each component, a physical degradation scenario was simulated and system behaviour in terms of pressure and volumetric flow rates were captured.

Figure 13 shows the variation of the pressure parameters in various points of the system vs. the degradation of the filter. As described in section 2, the filter degradation was emulated by gradually closing the DPV1 (see Figure 2a). Nine degrees of severity were generated corresponding to 100%, 90%, 80%, 70%, 60%, 50%, 40%, 30% and 20% valve opening. Position 100% valve open corresponds to a healthy filter, 20% valve open corresponds to an almost clogged filter. The mean values of the volumetric flow rate and pressure for each set of data (1 minute at 1kHz) were plotted against valve opening coefficients and the results were interpolated.

Although, a real operating environment might present more noise and the sensor sensitivity and accuracy as well as the parameters magnitude levels might be different on a real fuel system than in the test-bed, the effects of a failure mode on the real asset will be similar in both cases from a qualitative point of view.

Clogged filter diagnostic rule:

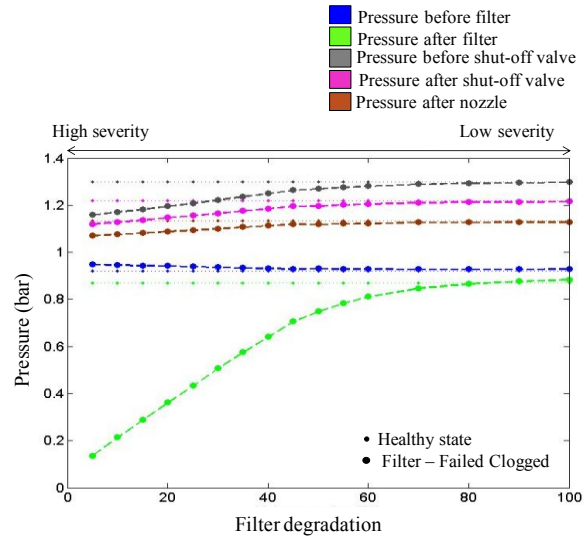
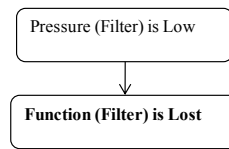

Figure 13. Pressure rates under a filter degradation scenario

From a diagnostic perspective, the pressure drop across the filter is generally used for the identification of a clogged filter (SAE J905, 2009). Functional approach demonstrated that by using strictly the pressure after the filter (the green signal in Figure 13), this failure can be fully detected and isolated. This quantifies in the reduction of the number of sensors required to identify a clogged filter. It is widely accepted that the reliance on one fault indicator (pressure after the filter) is not a robust detection method however one

potential solution to make the indicator more reliable might be the use of multiple redundant indicators that provide a means for resolving differences (e.g. by “voting”).

The degraded pump scenario was implemented by creating a leak after the pump component through the DPV2 (see Figure 2a). Initially, for the healthy situation, this valve was fully closed. Gradually, the DPV2 position was set to 10%, 20%, 30%, 40%, 50%, 60%, 70%, 80%, 90% and 100% open. The mean values of the volumetric flow rate and pressure for each set of data (1 minute at 1kHz) were plotted against valve opening coefficients and the results were interpolated. As in the previous case, difference between the emulation approach adopted here and the degradation of a real pump might exist however from a qualitative point of view, a degrade pump will provide a lower flow rate for the same load (system configuration) and same pump speed. On the test-bed, the pump controls have a feedback loop which keeps the pump speed constant at all time.

The diagnostic rule for detection and isolation of a degraded pump combines the variation of three parameters: the increase of the flow rate through the shut-off valve (equivalent to a decrease in pressure difference across the shut-off valve), the decrease in the pressure measured after the pump and the decrease in the pressure after the filter. The consistency of the diagnostic rule can easily be verified by observing the variation of parameters P2, P3 and the difference between P2 and P3 in Figure 14.

Degraded pump diagnostic rule:

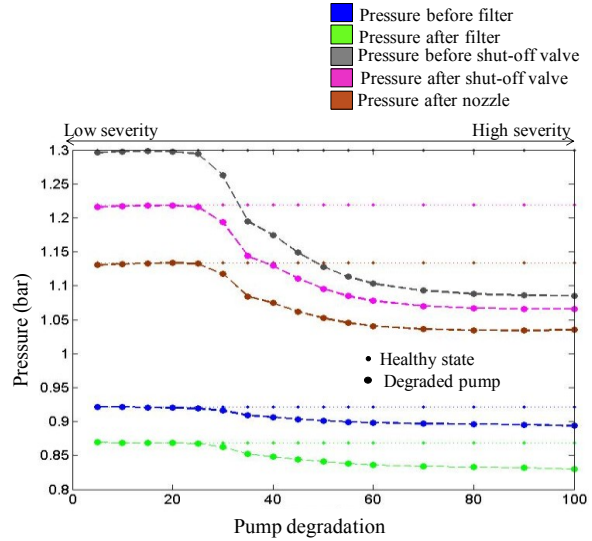
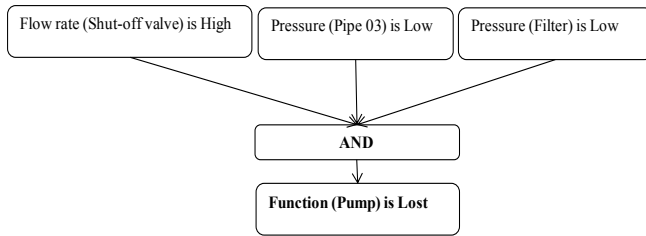
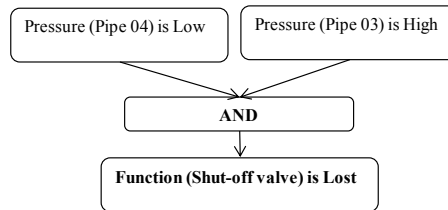

Figure 14. Pressure rates under a degraded pump scenario

The malfunction of the shut-off valve (stuck in a midrange position) was implemented by adding the DPV3 in line with the shut-off valve (see Figure 2a). Initially, for the healthy situation, the DPV3 was fully open. Gradually, the direct-acting proportional valve was closed and data was measured on the rig for 1 minute at 1kHz for the valve being 100%, 90%, 80%, 70%, 60%, 50%, 40%, 30%, and 20% open. The mean values of the volumetric flow rate and pressure for each set of data were plotted against valve opening coefficients and the results were interpolated.

The diagnostic rule for detection and isolation of a stuck shut-off combines the variation of two parameters: the increase in the pressure measured before the valve and the decrease in the pressure measured after the pump. The consistency of the diagnostic rule can easily be verified by observing the variation of parameters P3 and P4 in Figure 15.

Shut-off valve stuck mid range diagnostic rule:



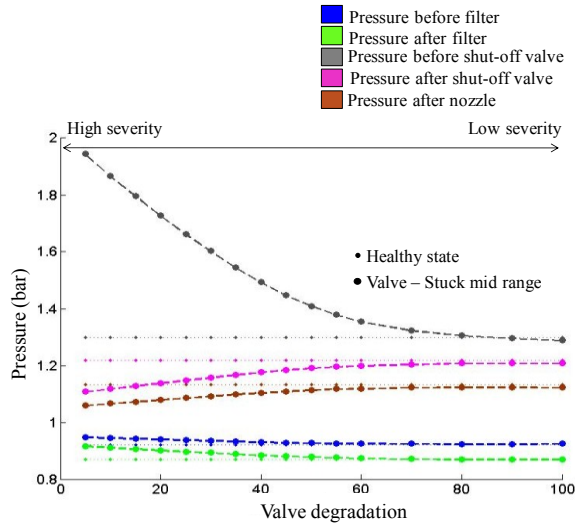

Figure 15. Pressure rates under a degraded shut-off scenario

The leaking pipe scenario was implemented by creating a leak after the pump component through the DPV4 (see Figure 2a). Initially, for the healthy situation, this valve was fully closed. Gradually, the DPV4 position was set to 10%, 20%, 30%, 40%, 50%, 60%, 70%, 80%, 90% and 100% open. The mean values of the volumetric flow rate and pressure for each set of data (1 minute at 1kHz) were plotted against valve opening coefficients and the results were interpolated.

The diagnostic rule identifying a leak in the Pipe 04 implies the drop in the flow rate through the shut-off valve (equivalent to the flow throughout the system). The consistency of flow in Figure 16a. The flow rate through the shut-off valve parameter can be interpolated from the pressure difference across the shut-off valve as per Figure 16b. The decrease of the flow rate through the shut-off valve is equivalent to the increase in the pressure drop across the valve (the difference between parameters P3 and P4).

Leaking pipe diagnostic rule:

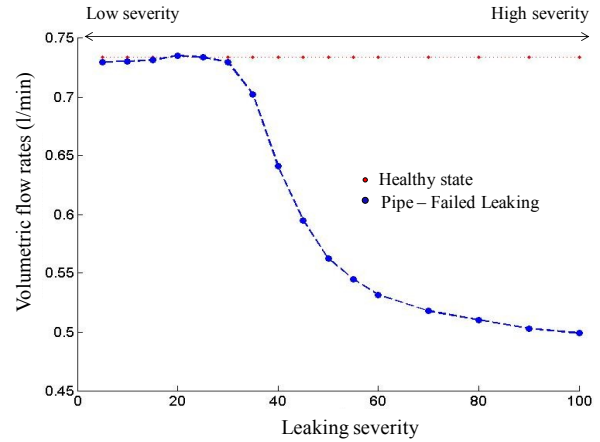
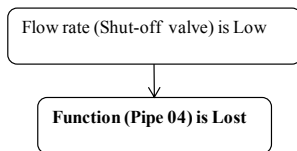

Figure 16a. Flow rates under a leaking pipe scenario

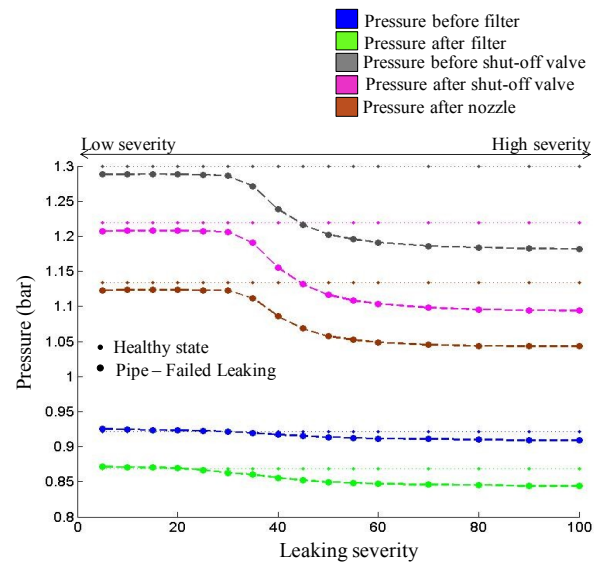

Figure 16b. Pressure rates under a leaking pipe scenario

The clogged nozzle scenario was implemented by replacing nozzle component with DPV5 (see Figure 2a). Initially, for the healthy situation, this valve was fully open. Gradually, the DPV5 was closed and data was measured on the rig for 1 minute for the valve being 100%, 90%, 80%, 70%, 60%, 50%, 40%, 30%, and 20% open. The mean values of the volumetric flow rate and pressure for each set of data were plotted against valve opening coefficients and the results were interpolated.

The diagnostic rule identified by the functional model as being capable of detecting and isolating the clogged nozzle involves the pressure measured before the nozzle. When this parameter increases above normal limits, the function of the nozzle is considered lost (equivalent to the nozzle being clogged). The consistency of this diagnostic rule can be verified by observing the variation of this parameter for all

degrees of severity of a clogged nozzle scenario (P4 in Figure 17).

Clogged nozzle diagnostic rule:

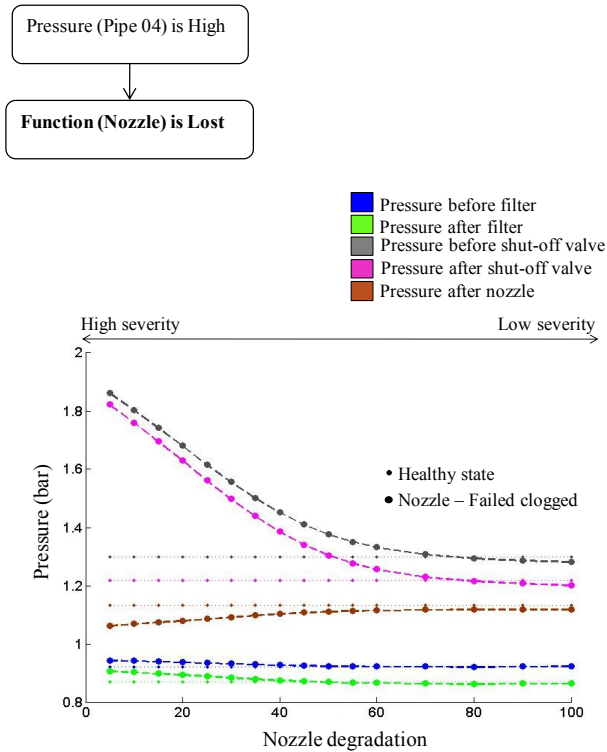

Figure 17. Pressure rates under a nozzle degradation scenario

To sum up, the sensor set solution identified by the functional analysis (four sensors – three pressure sensors and one flow meter) can be further minimized by inferring the flow rate from two of the existing pressure sensors. This second optimisation is strictly related to the implementation process of the sensor set solution on the real asset and is not part of the IVHM design process.

In order to incorporate the sensor set solution on a real asset and to deploy the diagnostic rules as part of the IVHM solution, several calibration procedures have been performed. As implied in Figure 11, diagnostic rules for a sensor set solution contain qualitative information only. Faults are indicated by deviations from nominal healthy values using *Low/High* indicators without a quantitative threshold defining the separation between “normal” and “low” conditions or between “normal” and “high” conditions.

6. DISCUSSION

The fuel system test case demonstrates that functional analysis can support the initial evaluation and assessment of functional-failure risks of physical systems. Functional

approach in general and MADe™ software in particular have interesting positive and negative characteristics. These are:

Pros:

1. Functional modelling brings a reasonable degree of methodology to the future automated processes of impact analysis. By integrating its rigorous taxonomy, functional modelling solves one of the shortcomings of the current IVMH design approach: the lack of a clear, unified and widely accepted ontology.
2. The whole reason for introduction of functional analysis was to offer designers a tool to be used during the conceptual design when there is no physical system. No previous information needs to be provided to the model regarding possible fault propagation routes. Diagnostic analysis tools like eXpress™ (Hilberth, 1995; Gould, 2004), ADVISE (Keller, 2007), TEAMS™ (QSI, 2012) require IVHM designers to explicitly build the fault propagation model by using causal relationships between part, component, sub-systems and systems. Regarding functional approach, only the information related to structural topology and system functionality are used as input parameters for configuring the model.
3. If combined with the appropriate information like difficulty of detection, progression rate, occurrence, probability, severity, functional analysis can complement and/or substitute safety and reliability analysis. It allows the designers to focus on functional failures rather than physical failures.
4. Another important feature of the functional analysis is its capability to identify end-effects (upstream and downstream) of a particular component failure mode. By employing FCM (Fuzzy Cognitive Maps) techniques, MADe is able to identify functional failures resulting from component interaction.
5. Functional approach can easily handle high complexity factors of the analysis. Any number of parts/components/sub-systems or system failures can be introduced in the model using failure diagrams (cause-mechanism-fault-functional failure). The advantages of modelling a system using a high degree of complexity remain though in discussion.
6. The health management solutions developed using this COTS functional analysis software become more reliable as they are constructed using models that incorporate simultaneously design, RAM and IVHM information.
7. Considering the multitude of multidisciplinary data incorporated into a functional model, it can be

concluded that functional analysis offers significant support for conceptual design analysis in vertical integration and system engineering.

Cons:

1. System designers might find the mindset shift from physical approach to functional approach difficult to adopt. The concepts underpinning the functional approach might be easier to be adopted by safety and reliability engineers.
2. Functional failure analysis provides only qualitative predictions of system parameter changes. Further tests and calibration procedures have to be performed in order to transform the functional analysis output into executable code.
3. It was demonstrated that the proposed instrumentation solutions obtained using functional approach are capable of detecting and isolating the faults defined in the fault universe. As they do not involve any physics, the authors have identified a drawback as no assessment can be undertaken regarding the efficiency of functional sensor set solutions for prognostic purposes at this stage.

7. CONCLUDING REMARKS

The paper has presented the results of an applied research project that combined functional analysis with behaviour simulation as a design aid for developing health management solutions.

First of all, a functional model of a fuel rig was developed using MADe™ and a series of analyses to aid the health management development process were carried out. The model of the system incorporates all its components, topology, functions, failure modes and failure diagrams, in order to simulate failure propagation paths and local, next and end-effects on other components. Care must be taken in setting up the functional model with the choice of component functions and inflow/outflow to these functions. The validation of the functional model consistency was made with reference to the physical simulation model of the same system. A functional model will be considered consistent when the functional propagation table incorporating failure effects on the system matches the physical propagation table containing the effects of similar failures.

Secondly, functional modelling for IVHM design and fuel system design cannot be done in isolation. This paper described the steps required to correctly develop a functional model that will reflect the physical knowledge inherently known about a given system. This means that during this development process, the model required several amendments including the use of several feedback loops to

replicate the upstream effects of a failure throughout the system in order to ensure good alignment with real physical behaviour. Since functional qualitative model makes explicit the essential distinction between normal and faulty conditions, it covers classes of components rather than individual ones, thus facilitating component libraries. The MADe™ framework employs modular, reusable function-component-behaviour models that can be integrated using an industrial standard.

Thirdly, the functional qualitative models offer means of expressing and exploiting approximate knowledge on a firm theoretical basis in a formal model. For instance, knowledge about qualitative deviations of component behaviour is used to identify the detection and isolation diagnostic rules.

If functional models are populated with reliability, availability and maintainability figures, the design engineers are able to systematically investigate functional-risks as early as possible during the design cycle. Simultaneously, the functional model increases the rate of success in deploying an IVHM solution with a reliable diagnostic logic. During the testing phase, the initial calibration of the diagnostic rules has to be done in conjunction with the physical simulation. This calibration will need further adjustments once the IVHM solution is fully deployed on the real system in real operating conditions.

Besides functional analysis, a further input to the PHM community is the construction of physical fuel system test-bed for assessment and validation of various IVHM design techniques. As future work, the diagnostic logic obtained using functional failure analysis will be tested on the real asset and the propagation of failures and assessment of their impact on the overall system capability will be compared with the results obtained by using other COTS IVHM design tools.

Areas identified for future work include the implementation of the proposed functional techniques on a large-scale, highly complex landing gear system and on a central frequency changer house, both systems having huge downtimes and high repair costs associated. These systems will allow investigations regarding the efficiency of the functional approach when used in various domains (hydraulic and electric).

ACKNOWLEDGEMENT

This research is funded by the IVHM Centre, Cranfield University. The authors would like to thank K. Keller and T. Wilmering at the Boeing Company, St. Louis and J. Stecki at PHM Technology for valuable discussion and guidance during this project.

REFERENCES

- Brignolo, R., Cascio, F., Console, L., Dague P., Dubois, P., Dressler, O., Millet, D., Rehfus, B., & Struss, P., (2001). Integration of Design and Diagnosis into a Common Process. *In: Electronic Systems for Vehicles, VDI Verlag, Duesseldorf*, pp. 53-73.
- Combitech, (2012), www.combitech.se/sv/Tjanster/Informationsforsorjning/Produkter--verktyg/
- DSI (2012). eXpress Diagnostic Software. <http://www.dsiintl.com/weblogic/Products.aspx>
- Hubka, V., & Ernst Eder, W., (1984). Theory of Technical Systems, *Springer-Verlag, Berlin*.
- Glover W., Cross J., Lucas A., Stecki C., & Stecki J., (2010). The use of prognostic health management for autonomous unmanned air systems, *Proceeding of International Conference on Prognostics and Health Management*, October 10-16, Portland, Oregon, USA.
- Gould E., (2004). Modelling it both ways: Hybrid diagnostic modelling and its application to hierarchical system design, DSI International, *AUTOTESTCON*, pp. 576-582.
- Hilberth, K., (1995). Dependency modelling as an input to MIL-STD TRD/TPS development. *AUTOTESTCON*, pp. 552-555.
- Hutcheson, R.S., McAdams, D.A. & Tumer I.Y., (2012). Function-based behavioural modelling. *Int. J. Computer Aided Engineering and Technologies*, Vol. 4, No. 3, pp. 250-271.
- Impact Technologies, (2012), <http://www.impacttek.com/Resources/SellSheetPDFs/ReasonPro.pdf>
- ITI, (2012). <http://www.itisim.com/simulationx/>
- Keller, K., Baldwin, A., Ofsthun, S., Swearingen, K., Vian, J., Wilmering, T., & Williams, Z., (2007). Health Management Engineering Environment and Open Integration Platform. *Proceedings of IEEE Aerospace Conference*, vol., no., pp.1-16 , paper no. 1319.
- Kirschman, C. F., Fadel, G. M., & Jara-Almonte, C. C., (1996). Classifying functions for mechanical design. *Proceedings of ASME Design Engineering Technical Conference and Computers in Engineering Conference*, Paper ID 96-DETC/DTM1504, Irvine, August 18-22.
- Kurtoglu, T., Johnson, S. B., Barszcz, E., Johnson, J. R., & Robinson, P. I. (2008). Integrating system health management into the early design of aerospace systems using Functional Fault Analysis, *in Proceedings. International Conference on Prognostics Health Management*, Denver, CO, pp. 1-11.
- Kurtoglu, T., & Tumer, I.Y., (2008). A graph-based fault identification and propagation framework for design of complex systems. *Journal of Mechanical Design*, vol. 130, no. 5, pp. 051401-1-051401-8.
- Kurtoglu, T., Narasimhan, S., Poll, S., Garcia, D., Kuhn, L., de Kleer, J., van Gemund, A., and Feldman, A., (2009). First international diagnosis competition - DXC'09, *In Proc. DX'09*, pp. 383-396.
- Malin, J. T., & Throop, D. R., (2007). Basic concepts and distinctions for an Aerospace ontology of functions, entities and problems. *in Proc. IEEAC*, pp 1-18.
- Pahl, G. & Beitz, W., (1988). Engineering Design: A Systematic Approach, *Springer-Verlag*. Berlin
- Rudov-Clark, Stecki C., & Stecki, J., (2009). The language of FMEA: on the effective use and reuse of FMEA data, *Sixth DSTO International Conference on Health & Usage Monitoring*.
- Rudov-Clark, S. J., Ryan, A.J., Stecki, C.M., & Stecki, J., (2009). Automated design and optimization of sensor sets for Condition-Based Monitoring, *Sixth DSTO International Conference on Health & Usage Monitoring*.
- QSI (2012), Testability engineering and maintenance system (TEAMS) Tool, <http://www.teamqsi.com/prods.html>
- SAE J905, (2009). "Fuel filter test methods", *SAE International recommended practice*
- Stone, R.B., & Wood, K.L., (2000). Development of a functional basis for design, *Journal of Mechanical Design*, pp. 359-370.
- Tumer, I.Y., & Smidts, C.S., (2011). Integrated Design-Stage Failure Analysis of Software-Driven Hardware Systems, *Computers, IEEE Transactions on* , vol.60, no.8, pp.1072-1084.
- Ullman, D., (1997). The Mechanical Design Process. 2nd ed., *McGraw-Hill*.
- Ulrich, K. & Eppinger, S., (1995), Product Design and Development, *McGraw-Hill*.
- Walker, M., & Kapadia, R., (2009). Integrated Design of On-line Health and Prognostics Management, *Proceeding of International Conference on Prognostics and Health Management*. San Diego, CA September 27 – October 1, USA.
- Wilmering, T.J., (2008). A practical examination of model reuse in support of health management application integration, *AUTOTESTCON*, pp. 189-194.

BIOGRAPHIES



Octavian Niculita gained his BSc in Automation Control and Computer Science (Technical University of Iasi, Romania). He undertook his PhD research at TUIASI, Romania and at the University of Ferrara, Italy as part of the European Doctorate of Sound and Vibration Studies. Since 2009 he has been actively involved in the first project of the IVHM Centre regarding health management development process and construction of test facilities for assessment of IVHM design and deployment software tools for high-tech, high value systems.

number of technical roles, gaining experience in aerodynamics, heat transfer, fluid systems, mechanical design, combustion, services and IVHM. He moved to Cranfield in July 2008 as Professor and Director of the newly formed IVHM Centre. He has led the development and growth of the Centre, in research and education, over the last four years. Ian is on the editorial Board for the International Journal of Condition Monitoring, a Director of the PHM Society, contributing member of the SAE IVHM Steering Group and HM-1 IVHM committee, a Fellow of IMechE, RAeS and ASME. He is the editor of the recent SAE book: IVHM – Perspectives on an Emerging Field.



Professor **Phil Irving** gained his BSc and PhD at Birmingham University. In the early 1970s he joined the very active fracture mechanics research group at Birmingham, performing some of the earliest measurements of fatigue crack growth thresholds in metallic materials. In 1973 he moved to the National Physical Laboratory where he developed techniques for determining stress corrosion cracking behaviour of steels in high pressure hydrogen gas environments, and continued with exploration of factors controlling fatigue cracking in high strength steels. In 1978 he began work at GKN Technology, the research and development organisation of the GKN Automotive group, where for the first time he became involved in putting his knowledge of fatigue and fracture to practical use in design and service life prediction of a wide range of automotive components. In 1991 he moved to Cranfield, accepting a CAA sponsored Chair in Damage Tolerance. In the time since then he has worked extensively on fatigue fracture and damage tolerance in helicopters and fixed wing aircraft. A continuing theme has been research into techniques and benefits of structural health monitoring to structural integrity of aircraft. This interest leads to his close involvement in the setting up of the Cranfield Integrated Vehicle Health Management (IVHM) Centre and his pursuit of IVHM and SHM research within the centre. In addition to his research work he has lectured and published extensively in his research areas and has been external examiner at undergraduate, masters and PhD level on many occasions. He is a Chartered Engineer and a Fellow of IM3.



Professor **Ian K Jennions** career spans over 30 years, working mostly for a variety of gas turbine companies. He has a Mechanical Engineering degree and a PhD in CFD both from Imperial College, London. He has worked for Rolls-Royce (twice), General Electric and Alstom in a

2012-08-20

Use of COTS functional analysis software as an IVHM design tool for detection and isolation of UAV fuel system faults

Niculita, Octavian

Niculita O, Irving P, Jennions IK. (2012) Use of COTS functional analysis software as an IVHM design tool for detection and isolation of UAV fuel system faults. Annual Conference of the Prognostics and Health Management Society, 23-27 September 2012, Minneapolis, USA.

<http://www.phmsociety.org/events/conference/phm/12/proceedings>

Downloaded from Cranfield Library Services E-Repository