

CRANFIELD UNIVERSITY

Y. HIRAYAMA

**HEAT AND MASS TRANSFER REGIMES
FOR COOLING AND DEHUMIDIFICATION
USING CHILLED WATER RADIATORS**

SCHOOL OF MECHANICAL ENGINEERING

PhD THESIS



CRANFIELD UNIVERSITY

SCHOOL OF MECHANICAL ENGINEERING

PhD THESIS

Academic Year 1997-8

Y. HIRAYAMA

**Heat and Mass Transfer Regimes for Room Cooling
and Dehumidification Using Chilled Water Radiators.**

Supervisor: W. J. Batty

February 1998

Abstract

The application of room radiators for the purposes of cooling and dehumidification in buildings for hot and humid climates is investigated. The radiator is purposely brought below the dew point temperature of the room air thereby creating condensation on the radiator surface. The condensate is then collected at the base of the radiator and removed. Mathematical models describing the heat transfer regime within a room when this system is used have been verified using climate chamber tests. The models show good agreement with the experimental results for radiator (a) with a height of 1 m, but not as accurate for radiator (b) with a height of 2 m. The underestimation of the real values by the convective heat transfer model used for the geometric construction of the radiator tested is attributed to the effect of air entrainment along the height of the radiator. Results indicate the importance of the radiant transfer component of the radiator, as well as its effectiveness to remove latent heat. In view of improving thermal comfort and energy efficiency, the implication of the results from this investigation of the heat transfer characteristics of the radiator used for cooling and dehumidification is such that the chilled radiator may offer a definite alternative to conventional air conditioning systems. Partial or full matching of the sensible and latent component of the radiator output to the load requirements of a building should prove particularly effective in hot and humid regions where the latent heat factor of the total cooling load is high.

Contents

List of Figures

List of Tables

Notation

1.	Introduction	1
2.	The Background to this Investigation	5
2.1	Introduction	5
2.2	Progression of the Concept of Thermal Comfort	6
2.2.1	Definition and Purpose	6
2.2.2	Comfort Indices and Comfort Models	9
2.2.3	Variations in Comfort Temperatures	17
2.2.4	Comfort in Hot and Humid Climates	23
2.3	Passive and Active Cooling Techniques in Humid Climates	26
2.3.1	Passive Approach and Latent Heat Gain	26
2.3.2	Control of Humidity	27
2.3.3	Active Solutions for Cooling of Buildings	31
2.4	Building Use in Practice and Future Trends	35
2.5	Conclusion	38
3	Heat Transfer Model of the Radiator	40
3.1	Introduction	40
3.2	Description of the Radiator	41
3.3	Radiator Heat Transfer Model	43
3.3.1	Radiation Heat Transfer	44
3.3.2	Convective Heat Transfer	50
3.3.3	Condensation Heat Transfer	54
3.4	Conclusion	58

4	Experimental Investigation	59
4.1	Introduction	59
4.2	Description of the Experiment Rig	60
4.2.1	Test Chamber	60
4.2.2	Radiator and Chilled Water Circuit	63
4.2.3	Sensors and Data Logging	65
4.3	Experimental Methods	66
4.3.1	Procedure	66
4.3.2	Calculation of the Individual Heat Transfer Rates from the Experimental Data	68
4.4	Conclusion	71
5	Presentation and Discussion of Experimental Results	72
5.1	Introduction	72
5.2	Heat Extraction Rates of the Radiators	72
5.3	Comparison between Theoretical and Experimental Results	81
5.3.1	Heat Transfer Components of the Radiator	81
5.3.2	Heat Transfer by Radiation	86
5.3.3	Heat Transfer by Convection	103
5.3.4	Latent Heat Transfer to the Radiator through Condensation	105
5.4	Conclusion	111
6	General Discussion	113
7	Conclusion and Recommendation for Further Work	119
	Reference	R.1
	Bibliography	B.1
	Appendix	A

List of Figures

Chapter 2

- Figure 2.1** p. 7
Experimental studies on accident frequency, human performance and comforts dependent on room temperature during tasks performed while sitting (1 met) and in light clothing (0.6 clo) according to DP Wyon [Daniels, 1997].
- Figure 2.2** p. 18
Mean subjective votes from surveys and PMV calculated from temperature, clothing and activity measured at the time plotted against mean room temperature [Humphreys, 1994].
- Figure 2.3** p. 21
The "adaptation hypothesis" of thermal comfort by Auliciems [de Dear, 1994].
- Figure 2.4** p. 22
Thermally neutral temperatures for free-running buildings and other buildings plotted against the monthly mean outdoor temperature [Humphreys, 1994].
- Figure 2.5** p. 32
Three mode air-conditioner operation, [Brundett, 1987].
- Figure 2.6** p. 37
Results of the investigation on the occurrence of symptoms of SBS in 44 buildings with different methods of ventilation / cooling by J. Røbens [in Daniels, 1997].

Chapter 3

- Figure 3.1** p. 42
Construction of the radiator investigated.
- Figure 3.2** p. 43
Sensible and latent heat exchange between the radiator and $n=5$ room surfaces, i.e. internal walls, floors, occupants etc.
- Figure 3.3** p. 47
Radiant heat transfer of the radiator using the two-surface approximation.
- Figure 3.4** p. 51
Schematic of the isothermal parallel plate channel.

Chapter 4

- Figure 4.1** p. 61
Schematic diagram of the experimental chamber.
- Figure 4.2** p. 62
Points of measurement in the test chamber in relation to the radiators (a) and (b).
- Figure 4.3** p. 64
Schematic diagram of the chilled radiator test operation.
- Figure 4.4** p. 69
Mean radiant temperature distribution in the test chamber with radiator surface temperature at 10°C.

Chapter 5

- Figure 5.1a** p. 74
Heat extraction rate of radiator (a) as a function of mean temperature difference, with $t_{a,ref} = 25^{\circ}\text{C}$.
- Figure 5.1b** p. 75
Heat extraction rate of radiator (a) as a function of the mean radiator surface temperature with $t_{a,ref} = 25^{\circ}\text{C}$.
- Figure 5.2a** p. 76
Heat extraction rate of radiator (a) as a function of mean temperature difference, with $t_{a,ref} = 27^{\circ}\text{C}$.
- Figure 5.2b** p. 77
Heat extraction rate of radiator (a) as a function of the mean radiator surface temperature with $t_{a,ref} = 27^{\circ}\text{C}$.
- Figure 5.3a** p. 78
Heat extraction rate of radiator (b) as a function of mean temperature difference, with $t_{a,ref} = 25^{\circ}\text{C}$.
- Figure 5.3b** p. 79
Heat extraction rate of radiator (b) as a function of the mean radiator surface temperature with $t_{a,ref} = 25^{\circ}\text{C}$.
- Figure 5.4** p. 80
Heat extraction rate of radiators (a) and (b) as a function of the mean radiator surface temperature with $t_{a,ref} = 25^{\circ}\text{C}$.
- Figure 5.5** p. 82
Comparison between theoretical and experimental total heat exchange.
- Figure 5.6** p. 83
Proportion of heat transfer by radiation, convection and condensation, for radiator (a) with $t_{a,ref} = 25^{\circ}\text{C}$.
- Figure 5.7** p. 84
Proportion of heat transfer by radiation, convection and condensation, for radiator (a) with $t_{a,ref} = 27^{\circ}\text{C}$.
- Figure 5.8** p. 85
Proportion of heat transfer by radiation, convection and condensation, for radiator (b) with $t_{a,ref} = 25^{\circ}\text{C}$.
- Figure 5.9** p. 87
Heat extraction rates by radiation, convection and condensation, for radiator (a) with $t_{a,ref} = 25^{\circ}\text{C}$.
- Figure 5.10** p. 88
Heat extraction rates by radiation, convection and condensation, for radiator (a) with $t_{a,ref} = 27^{\circ}\text{C}$.
- Figure 5.11** p. 89
Heat extraction rates by radiation, convection and condensation, for radiator (b) with $t_{a,ref} = 25^{\circ}\text{C}$.

Figure 5.12		p. 91
	<i>Comparison between the theoretical and experimental values of radiant heat transfer of the radiator.</i>	
Figure 5.13a		p. 93
	<i>Mean radiant temperature distribution in the test room without radiator.</i>	
Figure 5.13b		p. 94
	<i>Air temperature distribution in the test room without radiator.</i>	
Figure 5.14a		p. 95
	<i>Mean radiant temperature profile in the test room, with $t_{m,R} = 10^{\circ}\text{C}$, for radiator (a).</i>	
Figure 5.14b		p. 96
	<i>Air temperature profile in the test room, with $t_{m,R} = 10^{\circ}\text{C}$, for radiator (a).</i>	
Figure 5.14c		p. 97
	<i>Vertical air temperature profile along the central cross section in the test room, with $t_{m,R} = 10^{\circ}\text{C}$, for radiator (a).</i>	
Figure 5.14d		p. 98
	<i>Mean radiant temperature profile along the vertical cross section of the test room, with $t_{m,R} = 10^{\circ}\text{C}$, for radiator (a).</i>	
Figure 5.15a		p. 99
	<i>Mean radiant temperature profile of the test room, with $t_{m,R} = 10^{\circ}\text{C}$, for radiator (b).</i>	
Figure 5.15b		p. 100
	<i>Air temperature profile in the test room at height 1.1m, with $t_{m,R} = 10^{\circ}\text{C}$, for radiator (b).</i>	
Figure 5.15c		p. 101
	<i>Vertical air temperature profile along the central cross section in the test room, with $t_{m,R} = 10^{\circ}\text{C}$, for radiator (b).</i>	
Figure 5.15d		p. 102
	<i>Mean radiant temperature along the vertical cross section of the test room, with $t_{m,R} = 10^{\circ}\text{C}$, for radiator (b).</i>	
Figure 5.16		p. 107
	<i>Predicted average convective heat transfer coefficient vs mean temperature difference.</i>	
Figure 5.17		p. 108
	<i>Average convective heat transfer coefficient - Predicted vs Measured.</i>	
Figure 5.18		p. 109
	<i>Comparison between theoretical and experimental values of the latent heat transfer component.</i>	

Condensation rates on the surfaces of radiator (a) and (b).

List of Tables

Chapter 2

Table 2.1	<i>Estimation of individual components of heat losses from the body [Bansal et al., 1994].</i>	p. 11
Table 2.2	<i>Ratio of convective and radiative heat transfer of the human body based on empirical results [Humphreys, 1974].</i>	p. 12
Table 2.3	<i>Heat emission from human bodies at rest and during light work [CBISE, 1986].</i>	p. 13
Table 2.4	<i>Thermal indices incorporating different environment variables.</i>	p. 14
Table 2.5	<i>Neutral temperatures from climate chamber tests (at 0.6 clo) [Humphreys, 1994].</i>	p. 19
Table 2.6	<i>Latent load from internal and external sources for a test house in Florida [Arnold, 1980].</i>	p. 28

Chapter 4

Table 4.1	<i>Dimensions of the radiators, in metres.</i>	p. 64
Table 4.2	<i>Sensor characteristics after calibration.</i>	p. 65
Table 4.3	<i>Comparison of predicted and measured values</i>	p. 71

Notation

Symbols

A_{eff}	effective surface area of radiator, m^2
A	surface area, m^2
b	distance, m
c_p	specific heat, J/kgK
d	diameter, m
D	mass diffusivity, mm^2/s^1
F	view factor
g	gravitational acceleration, $(9.8 ms^{-1})$
h	heat transfer coefficient, W/m^2K
h_d	mass diffusion rate per unit area of surface, kg/m^2s
h_{fg}	latent heat of vapourisation, J/kg
h_m	mass transfer coefficient, m/s^2
H	height, m
k	thermal conductivity, W/mK
L	length, m
Le	Lewis number, -
\dot{m}	water mass flow rate, kg/s
\bar{Nu}	average Nusselt number, -
Pr	Prandtl number, -
Ra	Rayleigh number, -
R_m	universal gas constant, J/kgK
Re	Reynolds number, -
Sc	Schmidt number, -
Sh	Sherwood number, -
\dot{Q}	heat transfer rate, W
t	temperature, $^{\circ}C$
T	temperature, K
v	velocity, m/s
w	condensation rate per unit area, g/sm^2
W	condensation rate, g/h
x	specific humidity, g/kg

Greek Letters

α	thermal diffusivity, m^2/s
β	thermal expansion coefficient, $1/K$
ε	emissivity, -
ρ	density of air, kg/m^3

σ Stefan-Boltzman constant (5.67×10^{-8} , W/m^2K^4)

Indices

<i>a</i>	air
<i>ave</i>	average
<i>b</i>	distance of separation
<i>c</i>	convective
<i>gl</i>	globe
<i>i</i>	inlet
<i>j</i>	variable
<i>lat</i>	latent
<i>m</i>	mean (surface)
<i>mrt</i>	mean radiant temperature
<i>o</i>	outlet
<i>r</i>	radiant
<i>R</i>	radiator
<i>s</i>	surface
<i>sens</i>	sensible
<i>th</i>	theoretical
<i>w</i>	saturated
∞	ambient

1. Introduction

Generally, more than 80% of our lives are spent indoors as human activities are increasingly taking place inside buildings. Fulfilling the need to provide thermally “acceptable” indoor spaces has conventionally been the role of engineers who design, then install and commission heating and cooling systems in a nearly completed building. In view of the continuing demand for improvement in comfort and a trend toward a more integrated approach to the building design process, innovation in the systems used for heating and cooling buildings is becoming ever more important. Cooling equipment used in hot and dry climatic regions for instance, do not necessarily offer the best solution in more humid climates. However, building services systems generally in use today still comprise standard add-on devices, regardless of climatic conditions, which may be fundamentally limited in their capacity to provide higher levels of comfort and energy efficiency. A trend towards a more integrated approach to the building design process demands more innovative ideas from architects, engineers as well as from equipment manufacturers. The increase in variety of cooling and heating system options available could provide architects and building services engineers with opportunities to work towards optimal solutions taking into account the local climatic and social demands.

Within the research community, the outlook for novel approaches for the cooling of buildings are still mostly aimed at improvements in current technologies and passive cooling techniques [IEA,1992]. Passive cooling techniques enable buildings to be positively responsive to the surrounding climate such that the need for mechanical interventions are reduced or avoided altogether. However, in more extreme climates including those in large urban areas, use of passive measures may be limited, due to unfavourable ambient environmental conditions.

Regarding mechanical cooling, the main areas of current research are aimed at improvements in the performance of individual components of conventional systems. It must be noted however, that one of the most important aspects in the utilisation of

mechanical cooling is the sizing of cooling systems and equipment selection. The majority of cooling systems in use today are often oversized [IEA,1992].

The two main classical cooling systems used at present are packaged split-systems and conventional chiller water circuits. These “air-conditioners” rely on convective heat transfer between a heat exchanger to cool the air introduced to the room. These systems incur a number of losses arising from powering fans, part load inefficiencies and system losses; with additional pump losses and distribution losses. Furthermore, performances of these systems to provide thermal and acoustic comfort are poor [Vadon,1992]. However, improvements to items of plant equipment and advantages of flexibility and familiarity will ensure at least the short term continuation of these systems.

There are clearly opportunities for the development of alternative cooling systems with improved energy efficiency and comfort. The aim of this research is to examine the efficacy of utilising room radiators for the purposes of room cooling and dehumidification in a hot and humid climatic environment. Room radiator systems are well established for winter heating. The application of this technology for the purposes of cooling and dehumidification is a novel idea which has not been implemented successfully in the past. The chilled radiator system is envisaged for application in regions where high humidity, as well as the summer temperatures are the main factors causing occupant discomfort. The climatic conditions in most parts of Japan are such examples, where provisions for summer cooling and dehumidification as well as winter heating are required.

Recently, there has been renewed interest in thermal comfort issues. Defining thermal comfort criteria directly affects the cooling strategy developed for a building, thus the energy consumption rate during the lifetime of the building and ultimately the impact on the environment. Despite the wide acceptance and use of internationally established standards for defining thermal comfort, there are still many unanswered questions, particularly due to differences in laboratory-based results and results obtained from field studies. This may be due to the differences in response obtained from laboratory-based

experiments and those given during field studies. It is likely that the type of heating or cooling system in use will also affect the results of such surveys to some extent.

Although thermal comfort is predicted from consideration of the occupants activity level, amount of clothing, and environmental parameters which include air temperature, mean radiant temperature, air movement and humidity, the majority of mechanically heated or cooled spaces in practice are controlled solely by air temperature. This is largely due to the convective nature of the air-conditioning systems which are often the only option available for environmental control especially when cooling is required. However, the cycling ambient temperature caused by a convective system may contribute to occupant discomfort. In fact, there are indications that the mean radiant temperature may be a more important factor in the controlling of comfort than is generally realised [Schaezle, 1992]. The contribution of radiation heat exchange of the chilled radiators enables mean radiant temperatures to be actively controlled, which may significantly add to the options available for environmental control.

Occupants' health is another issue often highlighted in discussions on "Sick Building Syndrome". Air-conditioning systems are often implicated where the possibility of air contamination is a major concern especially where system maintenance is difficult or neglected. The application of chilled radiators separates thermal conditioning from ventilation problems, which could keep servicing simpler and more efficient. Furthermore, it would not constantly recirculate dust, pollen, and fungi that are found in the occupied space.

In order to identify the benefits of the radiator cooling systems on comfort, an overview of thermal comfort issues including different approaches to the formulation of comfort models is provided in Chapter 2. On the basis of this survey, comfort criteria relevant to the investigation of the chilled radiator cooling system are discussed.

In Chapter 3, the heat transfer mechanisms appertaining to the radiator in cooling mode are presented. When chilled water below the dew point temperature of the adjacent air is

circulated through the radiator, condensation occurs on the radiator surface, adding a latent component to the overall heat exchange. The theoretical heat transfer model involving both sensible and latent components is formulated.

Experimental apparatus and procedure for the verification of the heat exchange model of the radiator is presented in Chapter 4. The radiator performance was tested in a climate controlled chamber. Based on the results obtained from the experiments, analysis on the proportions of heat transfer due to convection, radiation and condensation follows in Chapter 5.

The study concludes by discussing the viability of using room radiators for the purposes of cooling and dehumidification in hot and humid climatic regions, based on the results of the experimental investigation, while taking into account various aspects of the discussion on thermal comfort.

2 The Background to this Investigation

2.1 Introduction

The investigation of the applicability of room radiators for cooling and dehumidification in buildings stipulates its primary objective, which is to provide a thermally comfortable indoor environment. Various research work in the field of thermal comfort has led to the establishment of internationally recognised standards which are commonly in use today.

Despite the existence of these established international guidelines, research on thermal comfort continues. This is mainly because there are still many unanswered issues, while new questions are arising, and there is still discomfort in buildings [*Raw and Oseland, 1994*]. The latter point in particular raises further questions.

- Are present thermal comfort prediction methods, and consequently comfort standards inadequate?
- How could heating and cooling equipment and their controls be modified or improved in order to reduce the occurrence of discomfort?

In this chapter, thermal comfort issues and different approaches to cooling of buildings are reviewed. Thermal comfort models in use today and the problems associated with these models are discussed. The relevant issues to the application of a radiator cooling system with dehumidification in hot and humid climatic environments are considered.

The scope of this research does not cover in detail all of the work related to thermal comfort. However, the key arguments vital for the application of cooling systems in buildings will be discussed, culminating in a proposal for an approach to assess thermal comfort related to this specific application.

2.2 Progression of the Concept of Thermal Comfort

2.2.1 Definition and Purpose

Buildings are inevitably linked to their surrounding environments. The need for mechanical intervention through the use of heating or cooling systems arises when the buildings cannot sufficiently attenuate the combined adverse effects of the environment and conditions created by the occupants themselves. Given the specified outdoor environmental conditions and internal heat and moisture gains and losses, such interventions, in conjunction with the building structure, must provide indoor environments that are thermally 'acceptable' or 'comfortable' for the occupants with appropriate attention given to the energy efficient operation of systems. In order to achieve this, defining 'thermal comfort' for the occupants as a guideline for building designers to use, has always been an important aspect in the field of building and building services.

To define desirable or disagreeable atmospheric and thermal conditions, Olgyay [Olgyay, 1962] stated that the effects of climatic environment can be defined negatively as the conditions that cause stress, pain, disease and death, and positively as those in which man's productivity, health, mental and physical energy are at their highest efficiency. The American Society of Heating, Refrigerating and Air conditioning (ASHRAE) defines thermal comfort rather vaguely as "that condition of mind which expresses satisfaction with the thermal environment" [ASHRAE, 1993a]. In practice, thermal comfort until recently has been inadvertently treated in a negative manner, often narrowly defined as the absence of discomfort [Evans, 1995]. Within the building environment, Stokols [Stokols, 1991] states that no buildings should cause ill health, but ideally they should promote good health. In fact, the role of thermal comfort as an aspect of general comfort, has been characterised as the most important within the building environment [Baillie et al., 1987].

The aim of providing a particular indoor thermal environment has wider consequences than simply securing 'acceptance' by the occupants. In the case of offices and work environments, productivity levels play an important role, and attempts are made to optimise ambient thermal conditions to maintain them. Figure 2.1 shows an overview of a study made by Wyon of the influence of room temperature upon accident frequency and performance levels during tasks carried out while sitting. The optimal level of work performance seems to lie in a relatively narrow range of room temperatures. However, other important factors including humidity, air velocity and surface temperatures are not accounted for, or are presumed ideal. These factors in fact, are key elements which will be discussed later in this chapter.

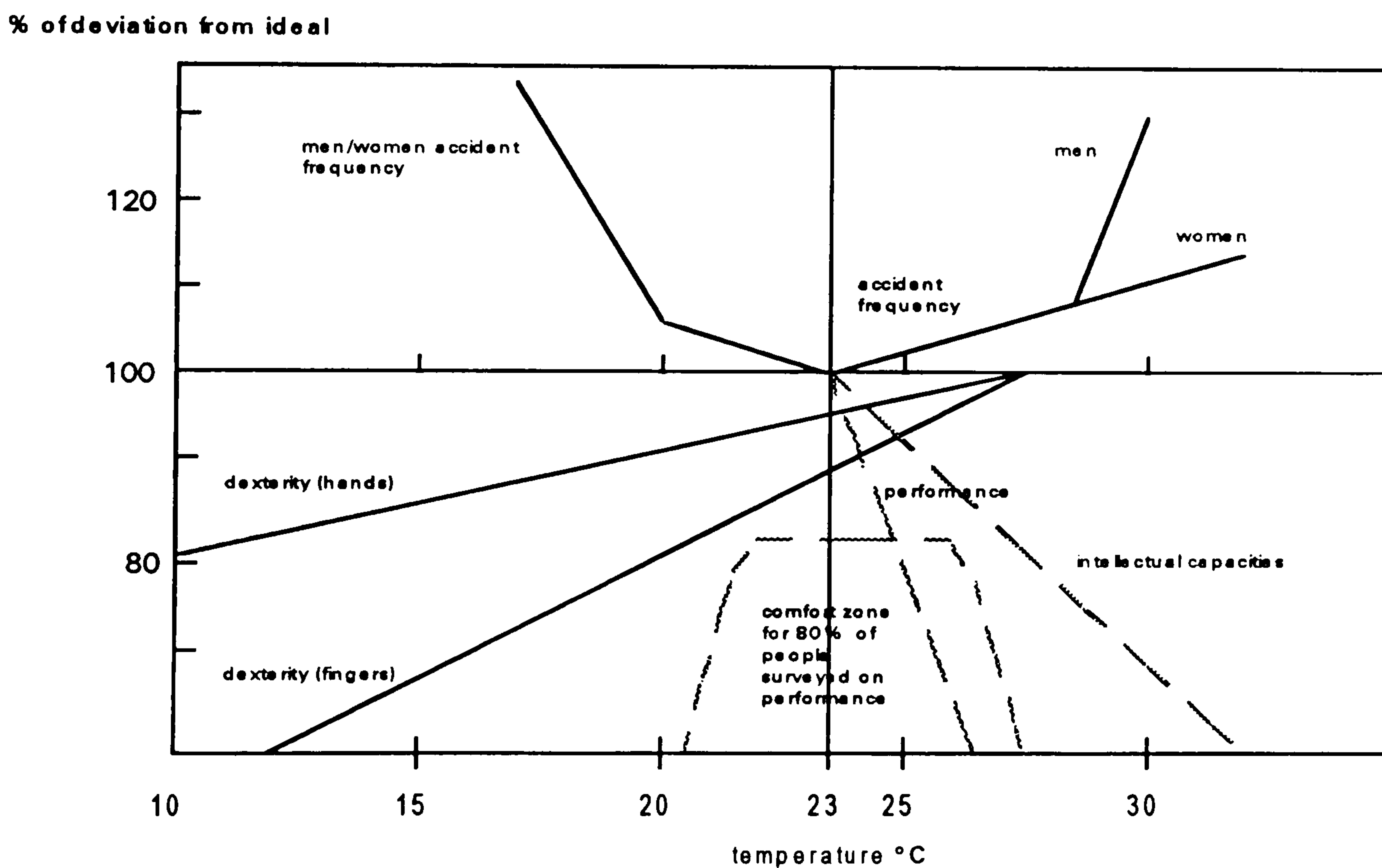

Figure 2.1 *Experimental studies on accident frequency, human performance and comfort dependent on room temperature during tasks performed while sitting (1 met) and in light clothing (0.6clo) according to D P Wyon [Daniels, 1997]*

The general health of the occupants obviously should be of utmost importance during consideration on thermal comfort. According to König [Daniels,1997], symptoms of the so-called Sick Building Syndrome (SBS) such as sense of fatigue, lack of concentration and aching joints could be caused by irregularities in the bodies' thermoregulatory response, for example through excessively high or low environmental temperatures, excessive relative humidity, or in some cases even from simple situations as lack of window ventilation.

Thermal comfort is not only about defining a particular neutral or comfort temperature. There are important parameters in the building environment such as surface temperatures, humidity, and air movements. Contributions of variables such as the occupants' physiological as well as behavioural response, climatic conditions, and influence of time cannot be ignored. Cultural differences as well as economic factors are known to affect perception of thermal comfort[Cena,1994].

If there is a group of people being subjected to the same indoor climate, it is likely that some will be more satisfied than others because of biological, emotional or physical variance. Therefore the aim has been limited to designing buildings which create the lowest percentage of dissatisfied occupants.

In practice, designers find it convenient to define a neutral *point* of thermal comfort, the simplest index of which is air temperature.

"The notion that a single temperature is right derives from the HVAC industry's ability to supply such a regime. In fact, the relationship between man and environment is complex and active, bringing in time, climate, building form, social conditioning, and so forth as well as the immediate physical environment." [Nicol,1993]

It is clearly easier for designers to design for a target value of a parameter than for a range of different conditions. Air temperature has been the dominant index of environmental monitoring and control, partly because mechanical cooling of buildings has predominantly been achieved through the use of air-conditioning systems. Considering the variety of results arising from research work both in laboratories and in the field, it seems that the control of thermal comfort conditions should not be narrowed to a *point* of 'neutral' or 'comfort' temperatures, but should be more loosely specified, with other environmental parameters more actively taken into account. Ideally, thermal comfort should be a reflection of all four environmental parameters, effectively implemented in practice, with considerations on the particular climatic region, taking into account the seasonal variations and the adaptive nature of human physiology and behaviour.

2.2.2 Comfort Indices and Comfort Models

The most fundamental and widely accepted parameters that affect thermal comfort sensation which are directly dependent on occupants, building design and technical plant are:

- **Activity level of occupants**
- **Amount of clothing**
- **Air temperature**
- **Mean radiant temperature**
- **Air velocity**
- **Humidity**

Thermal comfort can be generally achieved by many different combinations of the above variables. This means that a negative or positive effect of one variable may be counter-balanced by a change of another parameter.

The fundamental notion underlying thermal comfort models is that the human body must balance its heat gains and losses to the prevailing environmental conditions. This heat balance model forms the basis for the development of international standards *ISO 7730* and the *ASHRAE 55*. However due to the series of assumptions and certain limitations for which the heat balance equations are valid, its applicability in real situations have often been in dispute. As acknowledged by Fanger [1994] and Humphreys [1994], the main difficulty remains when the steady-state heat balance equations are applied to variable environmental conditions.

The Heat Balance Equation

Understanding the physics of the body heat exchange mechanism is nevertheless important for assessing heat transfer characteristics of different heating and cooling systems and their effect on comfort.

The balance between heat produced by the body as a result of its metabolic rate and the environment is achieved through heat transfer to and from the body by radiation, convection, diffusion, evaporation and respiration. The heat balance of the body with its environmental conditions could be expressed as

$$Q_{HP} = Q_{HL} \quad 2-1$$

$$Q_{HP} \text{ :Rate of body heat production} = Q_{RA} + Q_{CO} + Q_{DI} + Q_E + Q_{RE}$$

$$Q_{HL} \text{ :Rate of body heat losses}$$

The estimation of the individual heat exchanges are as follows:

Table 2.1 Estimation of individual components of heat losses from the body
[Bansal et al., 1994]

Radiation Q_{RA} (W)	$Q_{RA} = A_b \sigma (T_{cl}^4 - T_{MRT}^4)$	A_b : effective area of the body [m^2] σ : Stefan Boltzmann Constant ($\approx 5.678 \times 10^{-8} \text{ Wm}^{-2} \text{ K}^{-4}$) T_{cl} : temperature of the clothed body [K] T_{MRT} : mean radiant temperature [K]
Convection Q_{CO} (W)	$Q_{CO} = A_b h_c (t_{cl} - t_R)$	t_R : room air temperature [$^{\circ}\text{C}$] h_c : convective heat transfer coefficient [$\text{Wm}^{-2} \text{ K}$] with $h_c = 2.38(t_{cl} - t_R)^{0.25}$ $v < 1.0 \text{ ms}^{-1}$ $= 12.1 \sqrt{v}$ $1.0 < v < 2.6 \text{ ms}^{-1}$ v : velocity of room air [ms^{-1}]
Diffusion Q_{DI} (W)	$Q_{DI} = 0.32 A_b (P_s - P_a)$	P_s : saturated water vapour pressure at the temperature of the skin [mbar] P_a : water vapour pressure of the room air at room temperature [mbar]
Evaporation Q_E (W)	$Q_E = 0.42 A_b (Q_{HP} A_b^{-1} - 58)$	
Respiration Q_{RE} (W)	$Q_{RE} = 0.0017 Q_{HP} (59 - p_a) + 0.0014 Q_{HP} (34 - t_R)$	

The effective radiation surface area A_b is between 60 and 80% of the total body surface depending on posture [Fanger, 1970]. The fourth power law for radiant heat exchange can be approximated because of the relatively small temperature range in the building environment and expressed as

$$Q_{RA} = \varepsilon A_b h_r (t_{cl} - t_{MRT}) \quad 2-2$$

where ε is the emissivity of the clothed or skin surface and h_r is the linear radiation heat transfer coefficient [$\text{Wm}^{-2} \text{ K}^{-1}$].

The amount of heat exchanged by radiation to the surroundings and by convection to the air are roughly equal under normal conditions, i.e. when the difference between air temperature and mean radiant temperature is small. The gain or loss of heat by radiation

becomes important when there is a radiant source or sink within the room. If the mean radiant temperature is increased, the net radiation exchange with the surroundings is decreased, and if the mean radiant temperature is decreased the net radiation from the body is increased. This obvious mechanism is pointed out as a powerful technique for both heating and cooling especially in passive buildings [Bansal et al., 1994]. Heat loss by convection becomes predominant when there is significant air movement across the body. Under normal circumstances, any error in estimating the radiation loss will lead to an opposite error in the estimate of the convection loss. So the ratio of h_c to h_r is difficult to estimate with certainty. Some experimental results are shown in Table 2.2.

Table 2.2 *Ratio of convective and radiative heat transfer of the human body based on empirical results [Humphreys, 1974]*

	$h_c/(h_c+h_r)$	$h_r/(h_c+h_r)$
Gagge, 1941	0.52	0.48
Nielsen, Pedersen, 1952	0.58	0.42
Gagge, 1967	0.35	0.65
Colin, 1971	0.56	0.44

Sensible and Latent Heat Loss of the Body

Under normal conditions, 75% of the heat lost from the body is by sensible heat and 25% by latent heat. Hori et al. [1978] concluded that subjects native to hot and humid regions are more efficient at cooling their bodies through sweating. Ellis [1953] also found similar results in Singapore. In Japan, the wide use of air-conditioning systems in offices as well as in homes in recent years will probably have made these differences negligible. According to a study performed on Japanese subjects in climate chambers

[Tanabe, Kimura,1987], latent heat loss by skin diffusion is 10-12 Wm^{-2} , at environmental conditions of 23 to 26°C and 60% relative humidity, which is similar to that of Danish and American counterparts. Generally, the proportion of latent heat emission from the body increases with higher ambient temperatures as can be seen in **Table 2.3**.

Table 2.3 Heat emission from human bodies at rest and during light work [CIBSE,1986]

	ambient temperature	DB	15°C	22°C	24°C	26°C
at rest	<i>sensible [W]</i>		100	80	75	65
	<i>latent [W]</i>		15	35	40	50
light work	<i>sensible [W]</i>		110	90	80	70
	<i>latent [W]</i>		30	50	60	70

Thermal Indices

The environmental indices employed for thermal comfort assessment could be generally divided into three categories, as shown in **Table 2.4**.

Table 2.4 *Thermal indices incorporating different environmental variables*

Direct indices	Rationally derived indices	Empirical indices
dry bulb air temperature	mean radiant temperature	effective temperature ET
wet bulb air temperature	resultant temperature	new effective temperature ET*
dew point temperature	Predicted Mean Vote PMV	black globe temperature
air movement	Predicted Percentage Dissatisfied PPD	new standard effective temperature - SET*
	operative temperature	wet bulb globe temperature
	humid operative temperature	equivalent temperature
	heat stress index	wind chill index
	index of skin wettedness	

Aside from the direct indices, the most commonly employed indices are **resultant temperature, ET*, SET*** and the **PMV**.

The **resultant temperature** was first introduced by Missenard in 1931. It was originally defined as the equilibrium temperature of a globe thermometer, which was dimensioned to mimic the behaviour of the human body. Presently, ASHRAE recommends the use of the new or revised **effective temperature (ET*)**. The **ET*** is the dry bulb temperature of a uniform enclosure at 50% RH in which people have the same heat exchange by radiation, convection and evaporation as they do in the varying humidity of the test environment. **ET*** and **SET*** [Gonzalez and Gagge, 1973] are derived from the heat balance model and are closely linked to results from climate chamber tests.

All these comprehensive indices developed over the years take the different environmental parameters into account. However, it has been difficult to apply them for indicating the effect of individual environmental variables. Horikoshi et al, [1991] introduced 3 further indices; corrected humid operative temperature (**HOTV**), thermal velocity field (**TVF**), and reduced effective humid field (**RHF**). They are also derived

from the heat balance equation for the human body to indicate the combined influence of air velocity and humidity. These indices seem to be an effective means to express the effect of the different thermal environments on the human body. However, they are not verified for air velocities below 0.2 ms^{-1} , and only verified by association to thermal sensation vote by college-aged subjects.

The most globally used and possibly most influential comfort index at present within the heating and air-conditioning industry is the Predicted Mean Vote (PMV). Developed by Fanger [1970], the PMV index takes into account the various physical parameters with the occupants' activity and clothing levels to quantify the degree of comfort or discomfort, offering a practical method to predict thermal environments. Fanger's approach is to determine the conditions for heat balance of the body and then to analyse which of the conditions so defined are consistent with comfort. The PMV forms the basis for the *ISO Standard 7730*.

The Predicted Mean Vote

The PMV value is calculated according to the estimated heat transfer of the human body, including allowance for dry bulb and mean radiant temperature, air velocity, humidity, clothing insulation and metabolic rate. It predicts what comfort vote would arise from a given set of environmental conditions for a given clothing insulation and metabolic rate. The evaluation is on the basis of a subjective comfort scale by which sensations of cold or warmth are assigned scores ranging from -3 for too cold to +3 for too hot. By averaging the votes for a large number of people in a given environment, the mean vote is obtained. Because the PMV measures the average sensation for a large group, Fanger produced the statistical model in relation to the PMV known as the Predicted Percentage of Dissatisfied (PPD) and the Lowest Possible Percentage Dissatisfied (LPPD) which predicts the proportion of people who will be dissatisfied with a given thermal environment.

Limitations of the Heat Balance Model

There are ongoing critiques on the reliability of these comprehensive indices such as the PMV index which are based on the heat balance equation to provide predictions of comfort conditions. Some of the reasons given for this are as follows [Nicol,1993], [Humphreys and Nicol,1996]:

- subjective data on which the PMV model is based were obtained from climate chamber studies and in conditions where steady state had been reached
- the indices are designed to assess the thermal sensation only of the average person
- they require accurate knowledge of the occupants metabolic rate and the clothing insulation level, which in practice, are difficult to measure directly
- the PMV equation was only tested at 0.6 clo and other values were derived, therefore may lead to incorrect values of PMV whenever the clothing level differs from 0.6 clo
- the heat balance equations are derived with the assumptions that the system can be modelled as a lumped parameter system

These factors tend to influence the designer towards a highly serviced building producing closely controlled internal conditions appropriate to some assumed clothing and metabolic rates. The difficulty remains in the reality of the indoor conditions being inherently variable unless rigorously controlled by an air conditioning system. The increasing demand for energy efficiency and changing views on the use of air-conditioning systems are influencing designers towards opting for more flexible indoor environments, which may necessitate further reassessment of these comprehensive thermal comfort indices.

2.2.3 Variations in Comfort Temperatures

Climate Chamber and Field Studies

Thermal comfort studies consist of two different approaches, based on laboratory experiments and field studies. The former utilises results obtained from climate chamber studies in controlled experiments to investigate the effect of physical parameters on comfort. Fanger's PMV and Gagge's SET* for ASHRAE Standard 55 are the most widely known indices resulting from such studies. The latter is performed by conducting surveys in the field to measure the physical characteristics of the environment and relating these results to the occupants' comfort sensation.

There is a widespread view that empirical studies based on field surveys and analytical methods in climate chamber experiments result in significantly different values of thermal neutrality, i.e. temperatures at which the occupants feel comfortable [Nicol,1993],[Humphreys,1994],[Williamson,1995]. The discrepancy between average comfort vote obtained in the field and climate chambers has been reported to result in comfort temperatures varying by up to 4K [Schiller, 1990],[Oseland,1993]. Humphreys' [1994] comparison of actual comfort votes reported by occupants in the field studies and those predicted by the PMV model suggests that comfort temperatures may depend on the average room temperatures encountered as shown in Figure 2.2.

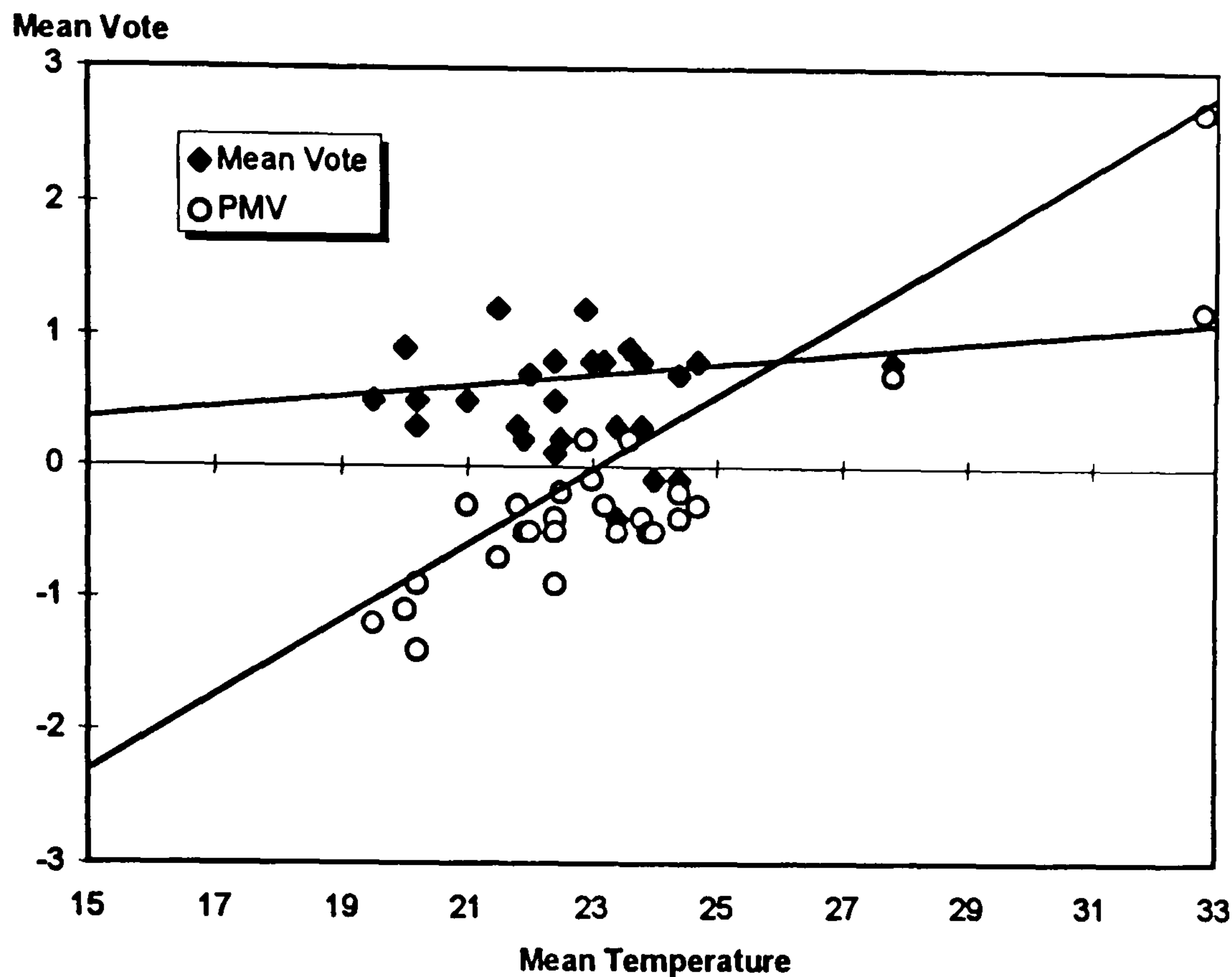

Figure 2.2 Mean subjective votes from surveys and PMV calculated from temperature, clothing and activity measured at the time plotted against mean room temperature [Humphreys, 1994]

The results imply that buildings heated according to accepted standards based on the heat balance model such as the PMV will be heated to temperatures higher than those required, and those cooled will be similarly overcooled.

An Australian field survey [Williamson, 1995] which included warm and humid climatic regions has also shown significant variation in the comfort temperature to the PMV predictions. Williamson argues that the standard methods of thermal comfort evaluation which provide the basis for the advice to designers are not sensitive to important context relevant factors such as the mean external temperature. The concept of seeking a neutral point of thermal comfort, which is central to the present comfort theories is also in question.

The ASHRAE Standard recommends a ‘comfort’ zone around a specific indoor temperature [ASHRAE, 1993a]. The ISO Standard 7730 is based on Fanger’s ‘comfort equation’ [Fanger, 1970], which assumes estimates of clothing insulation and metabolic heat production rate, and incorporates values for skin temperature and sweat production which were obtained from climate chambers under steady-state conditions. Within the results from climate chamber studies, the neutral temperature for thermal comfort is regarded to be invariant. However, data from various countries shown in Table 2.5 for individuals with 0.6 clo of clothing suggest this assumption does not hold true.

Table 2.5 *Neutral temperatures from climate chamber tests (at 0.6 clo) [Humphreys, 1994]*

Location of Investigation	t_n (°C)
Danish	25.7
American	25.6
Hong Kong Chinese	24.9
Sudan	29.0
Japanese	26.3
Chinese (Malaysia)	28.0
Malays (Malaysia)	28.7
Malays (London)	25.7
Singapore	26.4

Humphreys [1994] states that field studies should not necessarily be perceived as being in conflict with climate chamber investigations. However, he points out that sophisticated environmental variables do not always work well in field studies. A comprehensive index of thermal comfort such as the PMV or SET* show poor predictive ability and comfort conditions are often better explained by a simple index such as air temperature or globe temperature [Humphreys, 1994]. deDear and Auliciems

[1985] point out that simple linear regression equations based on the findings from 50 years of field surveys of thermal comfort were better predictors of neutral temperatures for that particular group than the sophisticated PMV model.

The differences in the results between climate chamber and field studies, and the wide variation of comfort temperatures obtained within climate chamber tests in different climatic regions seem to provide sufficient evidence to question the reliability of the steady state heat balance model, which is currently used by the HVAC industry internationally to set indoor temperatures.

The Adaptive Approach

An alternative method to the heat balance model is the adaptive approach [Humphreys, 1995],[Auliciems,1989], [deDear,1994],[Nicol,1993] which is based on the idea that people will make adjustments, behaviourally or physiologically when exposed to a particular environment to achieve thermal comfort. These adjustments could be accomplished for instance through choice of clothing, or use of controls such as opening windows or adjusting thermostats. When such a feedback system is in place, thermal comfort should be achieved after a period of time, when the occupants eventually achieve a state of dynamic equilibrium with the environment. The adaptive model by Auliciems depicting the hypothesis of indoor-outdoor climatic interactions with perception of thermal comfort is shown in **Figure 2.3** [deDear,1994].

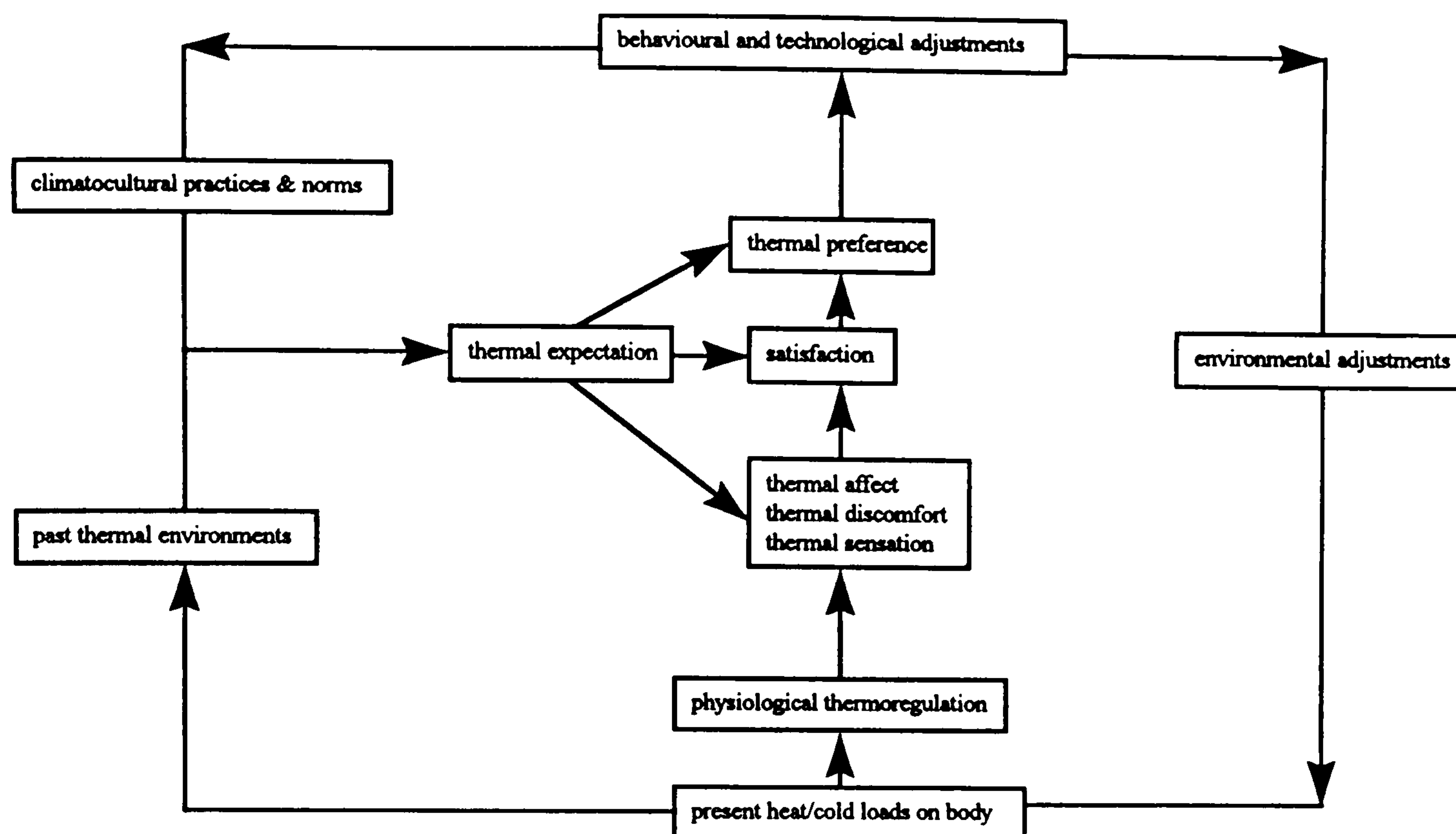

Figure 2.3 The “adaptation hypothesis” of thermal comfort by Auliciems [deDear, 1994]

Auliciems points out that the conditions of thermal comfort achieved under the adaptive approach is strongly influenced by the people’s *expectations* of what the indoor climate *should* be like, and that these expectations result from a confluence of one’s past thermal experiences, cultural and technical practices [deDear, 1994]. Availability and regular use of heating or cooling systems would be one such example.

The influence of outdoor climate on internal comfort conditions is most evident in Humphreys investigations [1994, 1995], shown in Figure 2.4. These data compiled from field surveys performed in the 1970’s show that the internal comfort temperature is likely to be strongly linked to the outdoor climatic conditions particularly in free-running buildings. Humphreys’ studies do not give any reasons for this relationship, however these data indicate there is potential for improving comfort guidelines if such evidence could be taken into account during the design of the building and heating or cooling systems. Discussions on ‘free-running’ buildings and thermal comfort are presented later in Section 2.3.

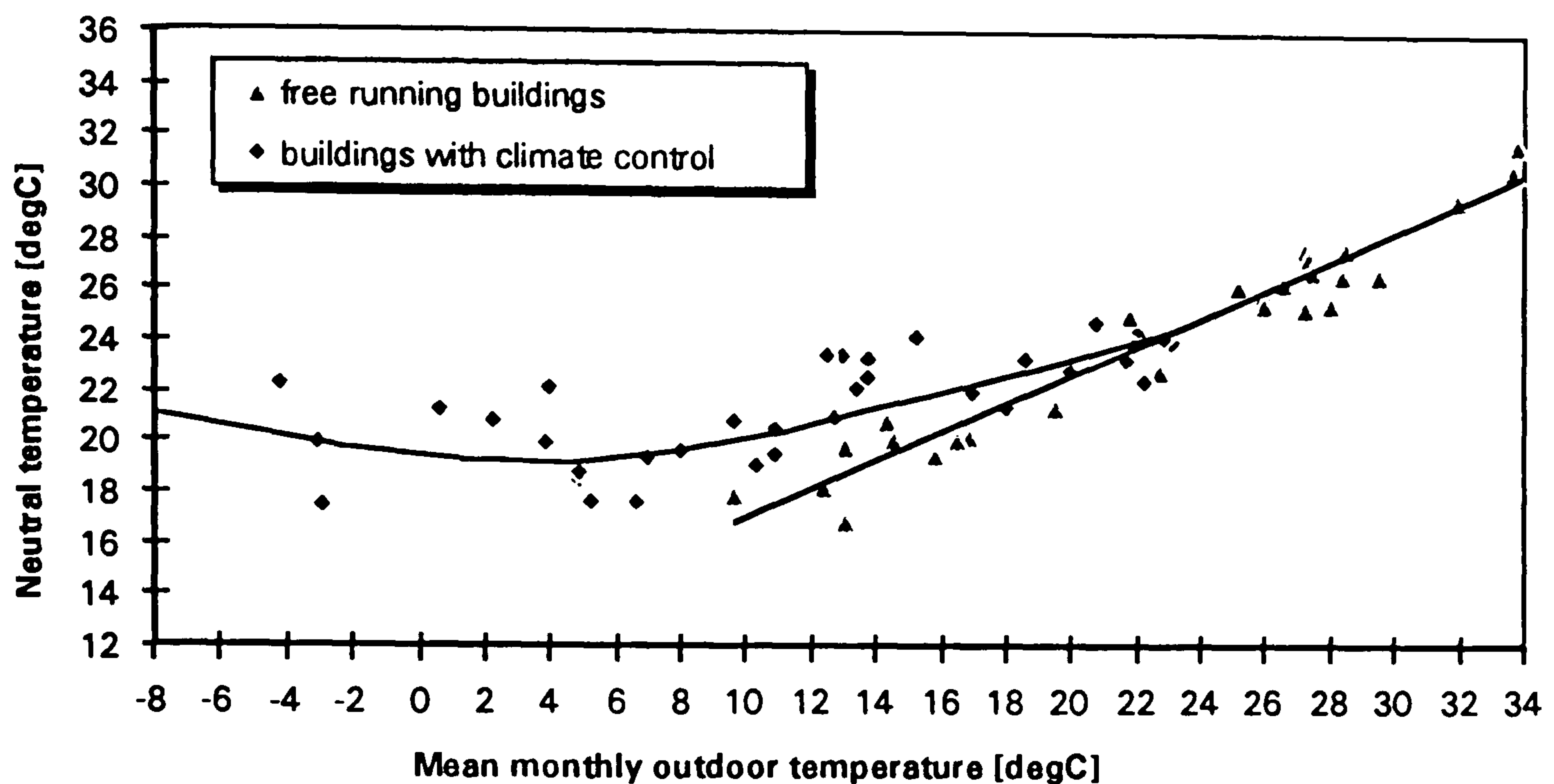

Figure 2.4 *Thermally neutral temperatures for free-running buildings and other buildings plotted against the monthly mean outdoor temperature [Humphreys, 1994]*

As a consequence of these data, Humphreys developed an adaptive approach which involves the notion that people interact with the environment to optimise their conditions. Some of the means by which this is achieved, relevant to this study are:

- the choice of design and construction of the building, such as shape, orientation, thermal capacity, glazed area and thermal insulation
- the choice of heating or cooling systems such as stoves, air-conditioning or radiant systems
- the use of controls including opening of windows or blinds
- the choice of clothing

The implication of having the choice of heating or cooling system is that people will have a certain expectation of the internal environmental conditions and its control capabilities and limitations.

Further development of the adaptive model and its possible implementation in future thermal comfort standards may lead to a more flexible interpretation of neutral temperatures, taking into account the expectations and the adaptive nature of the occupants. In practice, it may lead to demand in increased individual control capabilities for the occupants. Another possible implication is to design for less control of the indoor thermal conditions allowing temperatures to drift within a wider range than is common today and in direct relation to the outdoor conditions. These arguments would involve differences in preferred comfort conditions for a free-running and serviced buildings, with wider implications on energy use and building design as a whole.

2.2.4 Comfort in Hot and Humid Climates

After some inconclusive early laboratory studies (see Tanabe and Kimura [1987]) on subjective thermal comfort for people living in hot and humid regions, Tanabe and Kimura [1987] utilised the PMV and PPD model to evaluate comfort conditions for Japanese in hot and humid environments, which resulted in a neutral temperature of 26.3°C, not significantly different from earlier studies on Danish and American college-aged subjects.

In their study of Singaporeans who live in a hot and humid climatic condition throughout the year, deDear et al. [1991] found that the preferred ambient temperature in a climate chamber was to be no different from that of samples from colder regions. In another study however in naturally ventilated buildings, it was found that Singaporeans neutrality was 2K warmer than predicted by the PMV equation [deDear et al., 1991].

It is unlikely that acclimatisation to particular conditions have little or no effect on thermal comfort [Clark and Edholm, 1985], and that people living in hot and humid areas are acclimatised and have the ability to endure a hot environment [Frisancho, 1981], however this does not mean they *prefer* warmer conditions.

There have been several studies on the effect of humidity on the subjective perception of comfort [Tanabe and Kimura, 1987]; [deDear et al., 1991]; [Berglund, 1991]. In their climate chamber study of comfort sensation in hot and humid regions, Tanabe and Kimura [1987] used the comfort sensation vote (comfortable, slightly uncomfortable, uncomfortable, very uncomfortable) simultaneously with the thermal sensation vote (hot, warm, slightly warm, neutral, slightly cool, cool, cold) in order to investigate subjective effects of humidity on thermal comfort more closely. Their results show predictably that the subjects felt more uncomfortable at 80%RH than at 40%RH and 60%RH. They conclude that *comfort* sensation seems somewhat different from *thermal* sensation at high relative humidity. It should be noted that semantics in the cultural context may affect the results of such studies when sensation votes are translated.

Investigation by Berglund [1991] during the summer in air-conditioned spaces indicate that, “at the same temperature, occupants feel cooler with reduced humidity, as well as drier and more comfortable, and the air is perceived to be fresher, or less stale and stuffy, and is generally judged to be more acceptable”. Furthermore, the results suggest that occupants’ acceptance of air quality of the test space was more sensitive to humidity than was the acceptance of the thermal environment. Reduction in humidity affected the perception of air quality and freshness, but humidity was not as effective as a thermal parameter affecting comfort as air temperature. However, it must be recognised that perceived environmental quality, such as thermal comfort and air quality are closely interrelated.

When interpreting results obtained from steady-state chamber studies utilising indices based on the heat balance theory, it is important to recognise their inherent limitations.

However, various investigations on comfort conditions in hot and humid regions indicate clearly the importance of regarding humidity as an important factor, not only from the point of view of thermal sensation, but regarding overall perception of environmental quality.

2.3 Passive and Active Cooling Techniques in Humid Climates

2.3.1 Passive Approaches and Latent Heat Gain

Passive cooling is defined by Givoni [1994] as the lowering of the indoor average temperature below the outdoor level by the input of cooling energy obtained from natural renewable sources, i.e. through transferring heat from a building to various natural heat sinks. He distinguishes load minimisation measures in hot climates involving architectural design and choice of materials aimed at providing comfort while minimising the demand for energy used to cool a building as “bioclimatic architecture”. Technical and architectural methods as well as actions taken by building occupants themselves such as opening windows and using shades in order to avoid mechanical cooling will be generally classified as “passive measures” in this thesis. Various passive measures for cooling and dehumidification for hot and humid climates have been reported [Arnold,1980]; [Akridge,1982]; [Clark and Blanpied,1982]; [Khatter,1983]; [Fairey,1985]; [Cook, 1989]; [Bansal et al.,1994]; [Givoni,1994].

There are ideas implicated in the various investigations on passive measures that have important consequences for the practical usage of chilled radiators in hot and humid climates. One of these consequences is the recognition of the mean radiant temperature on human comfort. The pursuit of practical passive cooling measures has resulted in the increasing considerations given to the radiant environment and its potential to broaden thermal limits of acceptable comfort [Cook,1989]. Another consequence is that most passive load minimisation measures only deal with the sensible portion of the total cooling load, and therefore may increase the need for cooling systems that enable efficient removal of latent loads in hot and humid climates.

The ratio of the sensible load to the total load can be defined as the sensible heat factor **SHF**, and the ratio of the latent load to the total load as the latent heat factor **LHF**.

with $LHF=1 - SHF$

To achieve ideal cooling and dehumidification of the indoor environment, the SHF of the cooling load of the building and the SHF of the cooling system should match closely as possible.

There are no practical passive or so-called bioclimatic latent load reduction methods independently effective for hot and humid climates that are well-established within the building industry. Passive buildings only decrease the sensible load of the total cooling load, which inevitably leads to higher ratio of latent cooling load in humid climates. Combining passive or load reducing techniques and mechanical cooling systems i.e. air-conditioning may lead to an enhanced problem in hot and humid climates. Khatter's [1983] investigation in Florida has shown that in typical homes, use of high efficiency air-conditioning results in higher dew point temperature than with the use of conventional air-conditioners. In passive homes, this tendency was enhanced due to the lowered sensible cooling load. Air-conditioners in general cannot remove moisture from the air efficiently because compressors operate for limited periods of time due to the reduced total cooling load. In fact, high efficiency air-conditioners in use today are even more ineffective in dealing with the latent load separately, creating the increased need for dehumidification. In Japan, the HVAC industry has addressed the issue of dehumidification by developing domestic air-conditioning systems with dehumidification mode of operation (see Sec.2.3.2).

2.3.2 Control of Humidity

The critical shortfall of passive measures in hot and humid climates is the inability to cope efficiently with the high latent load. The latent load is comprised of moisture from

internal and external sources. Internal sources of latent gain come mainly from the occupants, cooking and showers. Water vapour that is transferred into the room through infiltration and permeation through the walls due to the water vapour pressure gradient between the outside and the inside make up the external load.

Table 2.6 *Latent load from internal and external sources for a test house in Florida [Arnold,1980]*

		approx. Moisture released (g/h)
Internal		
Occupants	adults at rest	73
	light activity	195
	heavy activity	260
Appliances	cooking (dinner for 4)	1220
Shower	5 minutes	113-230
Other	house plants (7)	18
External		
Permeation	wood frame	14
Infiltration/Ventilation	(1 ach ⁻¹ , 280 m ³ , normal cond.)	2000

- **Table 2.6** show the latent load from internal and external sources, adopted from Arnold [1980] for a test house in the hot and humid climate of Florida. The importance of ventilation or infiltration rates on the latent load of a building is apparent in hot and humid climates. If infiltration rates could be greatly reduced and carefully controlled, many passive cooling techniques effective in arid climates could possibly be utilised in hot and humid climates. Akridge [1982] states that in a hot and humid climate, the Detached Earth Tempering technique could be feasible provided controlled ventilation is accomplished through the use of an enthalpy exchanger. He suggests that for greater efficiency, latent and sensible loads should be handled separately. The use of regenerative desiccant substances for the dehumidification of the indoor air is another method considered feasible for humid climates. It is used in association with either traditional mechanical chillers or evaporative coolers which will deal with the removal of

sensible heat. Investigations on different desiccant substances and several applications have been reported [Arnold,1980].

Humidity in the air not only affects comfort sensations of the occupants as discussed earlier, but the levels of some indoor contaminants as well, such as formaldehyde [Kusuda,1983]. Suppression of mold and other micro-organisms and prevention of material degradation due directly to condensation are other reasons to control humidity to acceptable limits. However, the requirements for humidity control are not well defined. European and Japanese humidity control recommendations are based on relative humidity, while the *ASHRAE* comfort zone defines the upper limit of 17°C interior dew point, which is a result from the necessity to control growth rates of allergenic and pathogenic micro-organisms and not from human comfort requirements[*ASHRAE,1993b*]. At the lowest operative temperature in the summer comfort zone, provided the air temperature is equal to the mean radiant temperature, 17°C interior dew point results in a relative humidity of around 70%. In Europe and Japan, common practice bases humidity control standards on an upper limit of 70% relative humidity rather than on a dew point limit. However Clark [Cook,1989] points out that the upper limit of 17°C interior dew point may be unnecessarily restrictive and that human comfort requirements are less demanding than the 70% relative humidity limit. Many homes in the U.S. are routinely operated with interior dew point above 17°C [Cook,1989].

Unless humidity is “actively” controlled by a humidity sensor in the indoor space, with, for instance, control of a chilled-water valve on the cooling coil with a room dry-bulb thermostat controlling a downstream reheat coil, the humidity in the building is floating as an uncontrolled variable. The humidity in effect, is a function of the relative match between characteristics of the load on the space and the equipment serving it. A survey of buildings without active humidity control in humid climates by Todd and Pate [1987] including those in Japan, found that 60% of the buildings have relative humidities higher than 60%, and 40% have relative humidities higher than 70%. The occupants frequently

respond to their discomfort by lowering the thermostat settings, resulting in excessive cooling.

The use of relative humidity as a parameter for setting humidity limits may be misleading. If the objective is to maintain an upper relative humidity, an increase in air temperature would effectively be dehumidification while conversely a decrease in air temperature increases the relative humidity. This is a particularly important point when cooling strategies other than by conventional air-conditioning is being considered. By setting an upper limit of relative humidity, the diurnal cycles of ambient relative humidity may impose unnecessarily large dehumidification loads especially if indoor diurnal temperature fluctuations are allowed (see Sec.2.2) or natural ventilation / infiltration is the preferred method of providing fresh air.

There are a variety of factors involved in suppression of mold and mildew for the protection of building material such as air motion, local interior moisture sources, availability of sunlight on interior surface, temperature cycle of interior surfaces and moisture absorption characteristics of materials [Cook, 1989]. Diurnal cycles of interior relative humidity and other parameters that will inhibit growth of mold and mildew are still poorly understood. Assuming that the upper limit of 17°C interior dew point is unnecessarily restrictive, the main objective for humidity control will be for occupant comfort. Dehumidification or removal of the latent cooling load may more simply be described as the reduction of moisture content of the indoor air relative to the outdoor ambient conditions, independent of the relative humidity parameter. Reduction of humidity in the indoor environment in a hot and humid climate does not directly affect the thermal sensation of the occupants but affects the comfort sensation and subsequently the preferred indoor temperature, as stated in Section 2.2.4.

Room humidity levels are calculated from the mass balance equation between the humidity generation rate and dilution by infiltration or ventilation. Interior building surfaces have been recognised as a significant moisture storage reservoir. According to Tsuchiya [Kusuda, 1983], approximately one third of the moisture generated in a room

is absorbed by room surfaces. This results in lower room air humidity than calculated from the mass balance equation between the generation and dilution rate of humidity, which ignores the moisture absorption rate of the room surfaces. Tsuchiya's model for room humidity calculations was only validated under limited test conditions. However it is clearly a contributing factor to the proper design of humidity control.

2.3.3 Active Solutions for Cooling in Hot and Humid Climates

Air-Conditioning Systems

Over 75% of residential buildings and the vast majority of commercial buildings in Japan have some form of mechanical cooling systems for occupant comfort. Consequently, the reduction of power consumption during the peak periods in the summer has been a crucial aspect for the strategic considerations on energy policies as well as product development by HVAC manufacturers. The extremely high latent load prevalent particularly during the wet "rain" season due to excessive moisture content combined with moderate temperatures of the ambient air is another vital aspect facing the HVAC industry.

In order to cope with these difficult climatic conditions, the domestic air-conditioning units used in Japan are often being designed for 'three-season operation'. During the summer, they provide conventional cooling, while in winter they convert to an air-source heat pump by reversing the cycle and using the outdoor heat exchanger as an evaporator to provide a heat source. During the damp seasons when sensible load is relatively low, the air-conditioning is switched into a simple dehumidification mode in order not to lower the temperature excessively. Such modes of operation are performed either through the reduction of circulation air volume, which also reduces the dehumidification capacity, or by first dehumidifying by circulating the room air over the evaporator and then reheating over the high temperature condenser (see Figure 2.5).

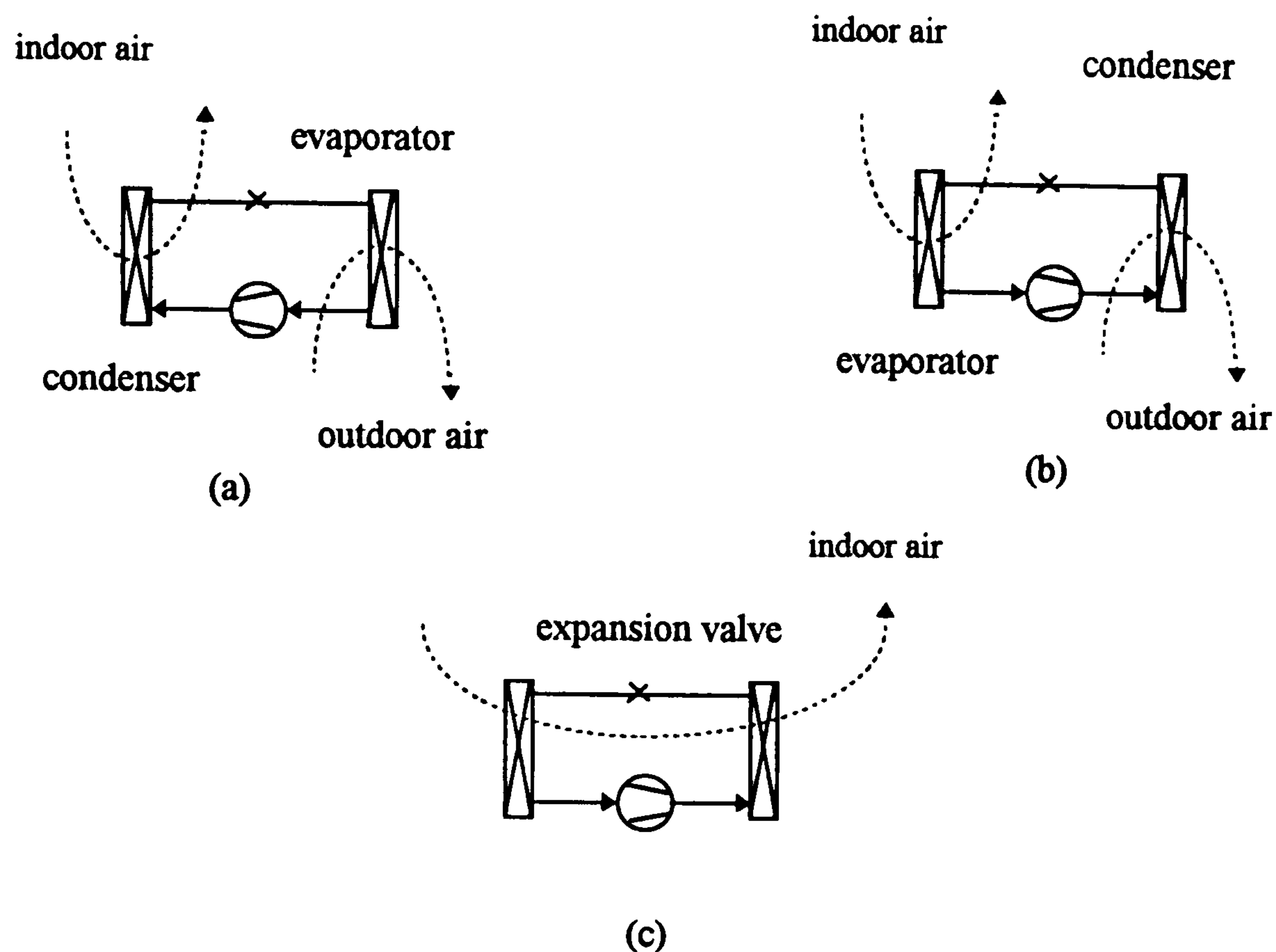

Figure 2.5 Three mode air-conditioner operation. (a) Heating cycle (b) Cooling cycle (c) Dehumidification cycle [Brundrett, 1987]

- Another recognised method for handling latent loads is the sensible heat exchange between the return and supply airstreams to improve the dehumidification performance. The heat transfer process pre-cools the air returning to the air conditioner, thereby increasing the latent capacity of the evaporator. Shirey [1993] has reported on the application of heat pipe heat exchangers to increase the cost-effectiveness and efficiency of sensible heat exchange between the supply and return airstreams.

Separate operation of mechanical dehumidifiers is another option. However due to the significant contribution to the sensible cooling load of the building as well as due to its high energy consumption rates, its application is still limited.

Generally, standard air-conditioning systems operate with a SHF of 0.75 to 0.85. In hot and humid climates, cooling load SHF could be around 0.6, and during the wet season, even lower due to the high humidity and moderate temperatures of the ambient air. During these periods, air-conditioners without specific dehumidification modes of operation are operating at very low efficiencies caused by the mismatch of sensible and latent loads between the building and the system.

Another problem with air-conditioning with thermostat control concerns the confusion of preferred operative temperatures [*Clark and Blanpied, 1982*]. Conventional thermostats measure air temperatures. Due to the high mean radiant temperatures in the summer, the operative temperature perceived by the occupants as comfortable is higher than the preferred thermostat setting particularly in residences. In other words, occupants must compensate for the high mean radiant temperatures by lowering the air temperature.

Radiant Cooling Systems

In European countries, the negative consequences of air-conditioned spaces both on occupant comfort and energy consumption and the recognition of the contribution of the mean radiant temperature to thermal comfort, have prompted the HVAC industry to consider alternative systems based on a higher radiant heat transfer component in occupied spaces. This has led to a significant development in the use of chilled ceilings and chilled beams, particularly in Germany. As these systems must operate above the dew point temperature at all times in order to avoid condensation on their surfaces, there are obvious limitations when applied in highly humid environments. The advantages of these radiant cooling systems could be identified as:

- higher level of comfort
- more energy and space efficient by using water as a heat transport medium

- low maintenance
- self adaptive control

Self adaptive control is a feature common to direct space cooling elements where the surface temperature is close to the space temperature. The rate of cooling decreases as the temperature in the space falls and requires fewer local controls [Arnold,1996], provided the condensation problem has been properly addressed.

There are various research work related to the use of radiant cooling systems in hot and humid climates particularly in Japan.

Kurihara et al.[1989] tested a chilled floor / ceiling system in a climate chamber to compare comfort levels between convective and radiant cooling systems. By maintaining the floor and ceiling at 25°C, comfort votes equal to air temperatures of 24 to 26°C were achieved with 28°C internal air temperature.

Comparison of subjective comfort votes and local skin temperatures of test subjects in a climate chamber cooled with a radiant and a convective cooling system was investigated by Wada et al.[1994]. Subjects in the chamber with a radiant cooling system produced better comfort sensation votes compared to the convective system. They assessed the advantages of a radiant cooling system on comfort as follows:

- skin temperature *differences* between various parts of the body (head, chest, lower body) decrease with time especially at globe temperatures above 23.5°C in the chamber with radiant cooling, while these differences remained unchanged at around 5K for subjects in the chamber with convective cooling under the same globe temperature values, which suggest occurrence of local discomfort
- there were fewer occurrences of “cold shocks” upon entering the chamber from a warmer environment with the radiant system

As with chilled ceilings, the disadvantage of using room surfaces as radiant heat sinks is that the surface temperature must be maintained above dew point temperature of the room air at all times, which often exceeds 20°C, requiring large surface areas for cooling with strict surface temperature control. The problem of high latent load must be handled separately.

Other investigations followed with similar conclusions [*Senuma et al., 1995*]; [*Hayano, 1994*].

2.4 Building Use in Practice and Future Trends

The development of theoretical solutions could benefit from gaining an insight as to how the occupants of buildings react to different conditions and their reasons behind their actions. By attempting to understand the way buildings are being operated in practice, some aspects of human behaviour in buildings and certain deficiencies of conventional design of systems could be identified.

A field study in the Tohoku Region of Japan [*Yoshino, 1994*] assessed the behaviour of occupants in highly insulated residential homes during the hot and humid summer. The results indicated that despite the availability of air-conditioning and mechanical ventilation systems, people have a tendency to depend on “passive” measures to alleviate the effects of summer heat, such as cross ventilation by opening windows or using shades by drawing curtains. The primary reasons given for the infrequent use of air-conditioning were factors related to discomfort, such as occurrence of cold draft, excessively low temperatures and noise. Energy conservation and savings on electricity bills were of minor importance.

A similar survey in the Tokyo area [*Kobayashi et al., 1995*] with very high summer temperatures and humidity during the summer of 1994 indicated that among the people who prefer not to use air-conditioning for comfort (21% of total respondents) the primary reasons were also perceptions related to health and discomfort.

In office buildings, air quality and health of occupants are of major concern when mechanical ventilation including air-conditioning is operated. In Europe, Røben [*Daniels, 1997*] has studied 44 buildings for symptoms of the so-called Sick Building Syndrome (SBS) occurring in fully air-conditioned, naturally ventilated and mechanically ventilated buildings (see **Figure 2.6**) The results of his investigation show that naturally or mechanically ventilated buildings have the lowest occurrence of problems and symptoms. However, naturally ventilated buildings have several inherent disadvantages as well. Some of them are:

- a significantly increased heating load
- room temperatures above acceptable levels
- periodic strong drafts due to oncoming winds
- periodic deficiency in air quality during windstill periods
- air quality is dependent on surrounding outdoor environment

These and other surveys regarding SBS [*Bluyssen, 1996*]; [*Weber, 1993*] indicate that HVAC systems could be a significant cause of building related sickness and proper maintenance and manageability seem to be vital. In both residential and office buildings, health and comfort remain an important issue which must be addressed especially when new systems are to be developed and put into use.

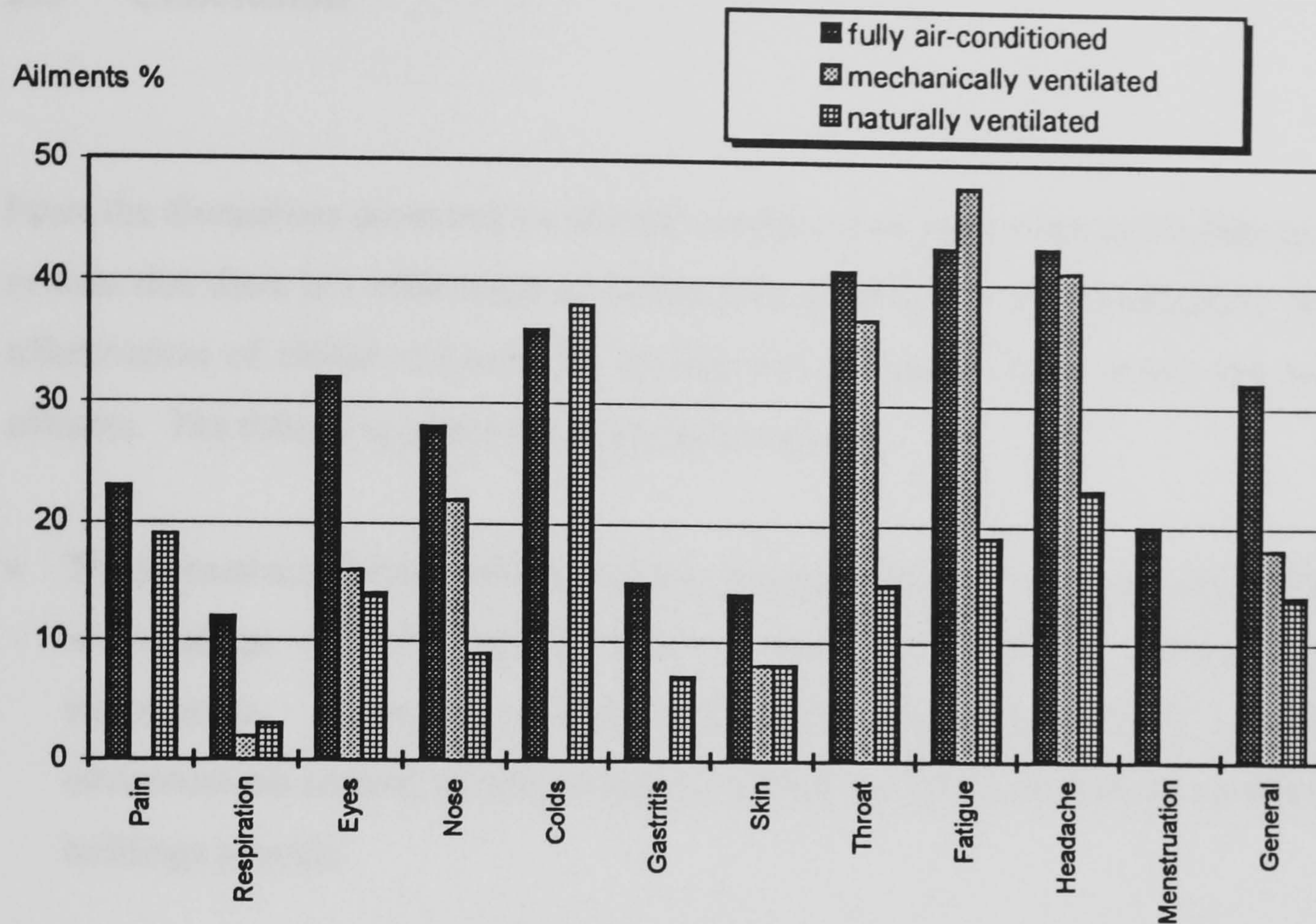

Figure 2.6 Results of the investigation on the occurrence of symptoms of SBS in 44 buildings with different methods of ventilation /cooling by J.Röbens [in Daniels, 1997]

The greater understanding of passive measures and natural ventilation techniques may lead people to demand these features both in residential and office buildings in the future where surrounding environments allow them to do so, not only from an energy conservation viewpoint but for the purpose of improving the internal environment.

There is also a view that cooling loads will increase in office buildings owing to increased use of information technology. The proportion of cooling loads to heating loads will certainly increase as higher insulation standards are put into practice.

2.5 Conclusion

From the discussions presented on thermal comfort, cooling systems and buildings, it is evident that there is a wide range of factors that contribute to the investigation on the effectiveness of chilled radiators for cooling and dehumidification in hot and humid climates. The following points are of particular interest:

- The thermal comfort model based on the thermal balance of the human body with its surroundings define a narrow band of comfort conditions, particularly air temperature. There is evidence that people are more tolerant of looser environmental control, notably of higher summer temperatures than air-conditioned buildings provide.
- The differences in the interpretations of comfort conditions are particularly evident in “free-running” buildings.
- Demand in buildings that are capable of “free-running” operation, with more passive features may increase in general, both from the point of view of energy conservation as well as on the basis of preferred comfort conditions evident from the surveys. Particular interest may be the provision of natural ventilation whenever applicable.
- The contribution of the mean radiant temperature for environmental control could help provide the potentially wider comfort range.

Furthermore, the specific problems encountered in hot and humid climates are:

- The **SHF** of the building and the equipment should match closely if the latent load is to be handled properly. This is particularly difficult for buildings with passive features due to the reduced **SHF** of the total cooling load.
- The efficient removal of the latent load is a vital factor both for occupant comfort and for the protection of building materials.

These are important opportunities for the design of cooling systems, particularly to assess the effectiveness of chilled radiators with dehumidification.

3. Heat Transfer Model of the Radiator

3.1 Introduction

Radiator heating and cooling systems contribute to providing thermal comfort by elevating or lowering the mean radiant temperature of the indoor environment and by heating or cooling the surrounding air that comes in contact with the radiator surface. ASHRAE defines any controlled surface as radiant panel systems if “50% or more of the heat transfer is by radiation to other surfaces seen by the panel” [ASHRAE,1996]. Free standing room radiators are assumed to have a radiation heat transfer component between 10 and 50% of the overall heat exchange [EN 442-2,1997]. The exact contribution of the radiant transfer is difficult to determine in actual installations, and manufacturers’ data available are often rough estimations. Chilled radiator system has the added component of latent heat transfer due to condensation on its surfaces. In this chapter, the theoretical model of the heat exchange between the radiator and its surroundings is formulated. The heat transfer mechanisms involved are radiation, convection and condensation.

3.2 Description of the Radiator

Room radiators are defined as free-standing heat transfer elements which directly exchange heat with the air and surrounding surfaces of the room. They are different from integrated heat transfer elements, such as floor heating surfaces or chilled ceilings. The common materials used for the manufacture of room radiators are, steel, aluminium, cast iron or even plastic. The characteristics of heat transfer with the surrounding air form the basis for the distinction between different types of room radiators. The heat transfer rate from the water within the radiator to its exterior surface is high, such that differences between different radiators are indistinguishable. Generally, the variation of radiators are categorised by their specific construction as *[Bach,1981]*

- column-type: air flows freely between the heating elements
- panel (plate) type: air flows in front and behind the panel only
- convector type: with flow enhancing casing
- combination type: panel type with convection fins for increased surface area for contact with the surrounding air

The radiator type chosen for this investigation was a column type steel radiator, comprised of vertical flat pipes welded together to round horizontal pipes at the top and bottom. Each vertical pipe is connected to the horizontal “distribution” pipes through a small connection hole enabling the flow of water through each element of the radiator (see **Figure 3.1**).

This type of radiator was chosen for the following reasons:

- large surface area available for heat transfer per installed wall area
- construction was suited for free convective air flow

- construction enabled condensation droplets to be easily disposed of, which is important for enhancing condensation rates
- aesthetic design, i.e. more likely to be acceptable when used as architectural elements inside buildings, such as room dividers

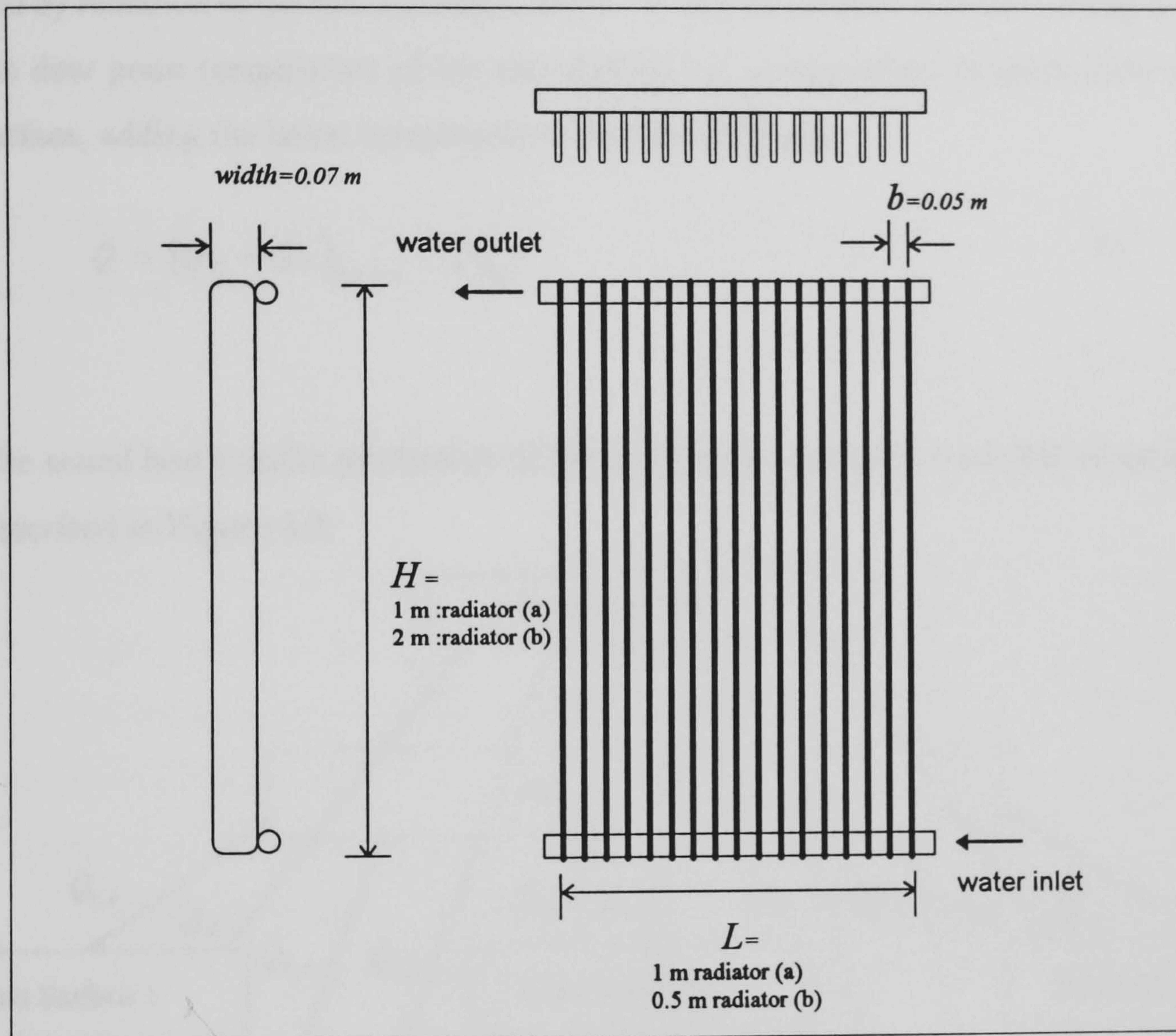

Figure 3.1 Construction of the radiator investigated

3.3 Radiator Heat Transfer Model

The heat transfer model of the wet chilled radiator can be divided into sensible and latent heat transfer. The sensible heat transfer occurs by free convection to the surrounding air and by radiation to the surrounding surfaces. When the radiator surface is brought below the dew point temperature of the surrounding air, condensation droplets form on the surface, adding the latent component of the heat exchange.

$$\dot{Q} = (\dot{Q}_c + \dot{Q}_r)_{sens} + \dot{Q}_{lat} \quad 3-1$$

The actual heat transfer mechanism of the radiator in a room for n number of surfaces is described in Figure 3.2.

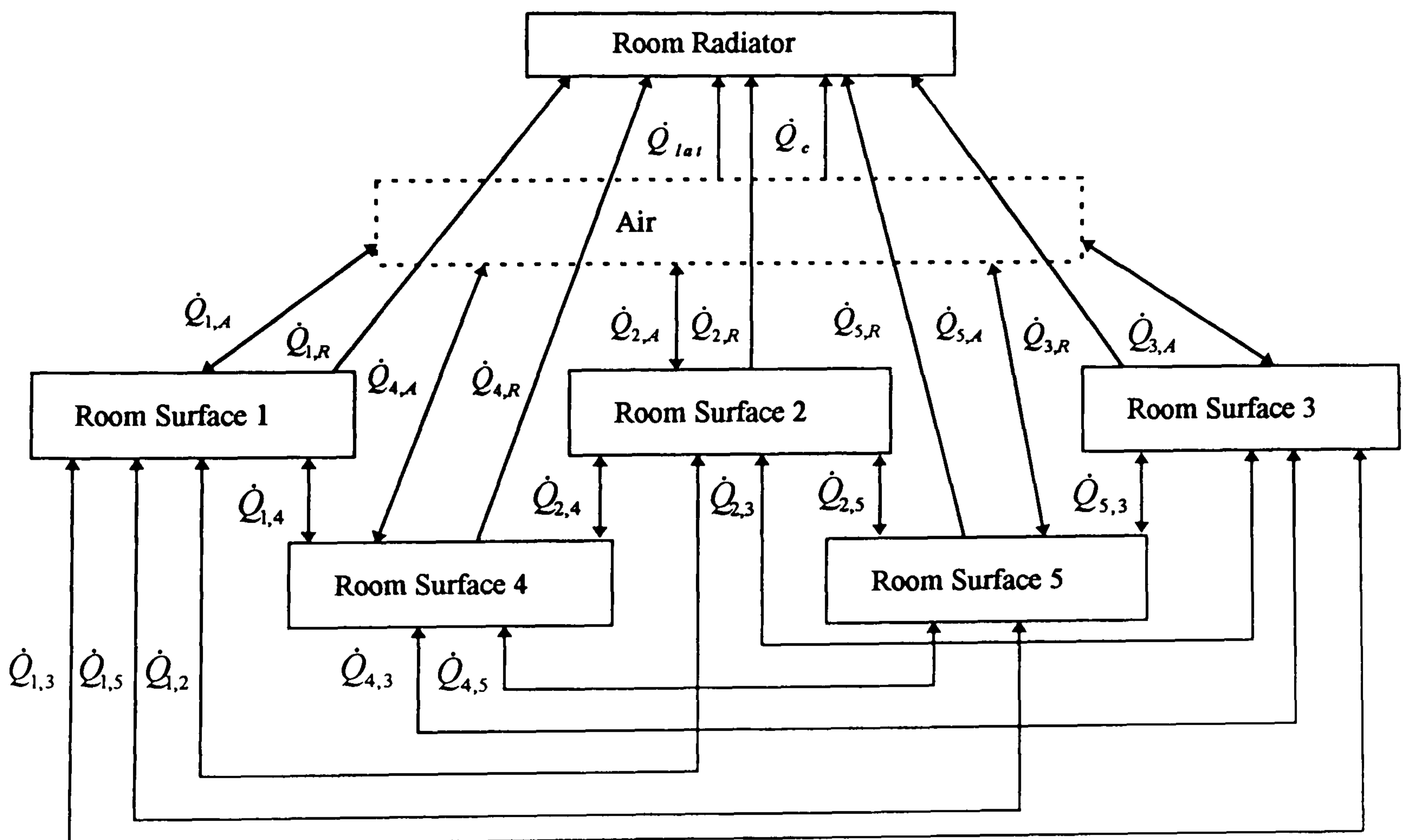

Figure 3.2 Sensible and latent heat exchange between the radiator and $n=5$ room surfaces, i.e. internal walls, floors, occupants etc.

3.3.1 Radiation Heat Transfer

All surfaces above absolute zero emit thermal radiation. Surfaces separated by a medium which does not absorb radiation, exchange energy between one another due to the processes of emission and absorption. In order to simplify the complex geometry of the room radiators tested for radiant heat transfer purposes, they are treated as rectangular panels, with the effective area calculated from the dimensions equal to the outer length L , width W , and height H , of the radiator (see Fig.3.1), placed in an enclosure.

The radiant exchange between surrounding room surfaces and the surface of the radiator can be described by

$$\dot{Q}_r = F_j A_{eff} \epsilon_j \epsilon_R \sigma (T_j^4 - T_m^4) \quad 3-2$$

with T_j in Kelvin is the surface temperature of the surrounding walls, and T_m for the heat sink, which denotes the average surface temperature of the radiator. The view factor F_j accounts for the geometric configuration of the proportion of emitted radiation from the surrounding surfaces absorbed by the radiator surface. The effective area A_{eff} of the radiator is calculated from the dimensions of the outer “frame” of the radiator (see Table 4.1). The emissivities are $\epsilon_R = 0.92$ for the painted radiator surface, and $\epsilon_j = 0.9$ is used as the emissivity of the room surfaces. σ is the Stefan-Boltzman constant ($5.67 \times 10^{-8} \text{ Wm}^{-2} \text{ K}^{-4}$). The average surface Kelvin temperature of the radiator is assumed to be the mean of the flow (entry) and outlet temperatures of the cooling water, i.e.:

$$T_m = \frac{(T_i + T_o)}{2} \quad 3-3$$

For simplification, the linear heat transfer coefficient for radiation could be utilised for relatively small temperature differences as in this application, thus

$$h_r = F_j \varepsilon_j \varepsilon_r \sigma \frac{T_j^4 - T_m^4}{T_j - T_m} \quad 3-4$$

and the radiant proportion of the radiator heat exchange may be written in the linear form

$$\dot{Q}_r = h_r A_{eff} (t_j - t_m) \quad 3-5$$

Radiation Heat Transfer - Two-Surface Approximation Model

The analytical method of obtaining the radiant portion of the heat extraction rate involves an accurate estimation of the individual view factors to the radiator, as well as the accurate values of the room surface temperatures, considered to be isothermal for each surface. In practice, the surface temperatures other than the radiator are often approximated by assuming them to be equal to ambient air temperature, which could lead to significant errors, where surface temperatures differ from the air temperatures.

In fact, the determination of the radiant heat transfer component of room radiators are not well documented and often not properly measured. Radiator manufacturers' data are often seen as rough approximations.

For practical purposes, it would be convenient if simple radiation models could be used to estimate the radiant heat transfer component of radiators accurately without view factor calculations of individual room surfaces, which are not always isothermal. Therefore, calculation algorithms of internal long-wave radiation energy transfer within rooms [Davies, 1987, 1992], [Walton, 1980] were considered to see if they could be developed to obtain close approximations of the radiation exchange by the radiator.

Stefanizzi et al. [1990] tested the performance and accuracy of various internal long-wave radiation models by applying them on simple to complex geometric configurations and comparing the results with the analytically exact method. In the tests, the important variables of temperature, emissivity and geometric configuration were altered one at a time in each algorithm in isolation. The radiation exchange models tested varied in complexity from accurate calculation of view factors with multiple inter-reflections between surfaces to simple, non-geometric methods using fixed heat transfer coefficients. According to this study, relatively simple models, such as Walton and Davies' models usually performed as well as the more complex models, such as ESP(1) and DEROB, particularly if simple six-sided rectangular geometries were used.

Walton's 'mean radiant temperature' method based on two-surface approximation is a theoretical model for radiant interchange in a room by assuming that each room surface radiates to a fictitious surface that has an area, emissivity and temperature giving about the same heat transfer from the surfaces as the real multi-surface case. In this so-called mean radiant temperature method, the net radiation heat transferred to the radiator surface can be estimated without individual determination of view factors, provided the surface temperatures and the emissivities of the room and the radiator are known.

For this study, the two-surface approximation model for room internal radiation exchange based on Walton's model is modified to produce the radiant component of the radiator heat exchange, and compared with the theoretical results, utilising equation 3-2.

The Modified Mean Radiant Temperature Method

The two-surface approximation model of the mean radiant temperature method for radiant interchange in a room, described in Figure 3.3, is defined by assuming that each room surface radiates to a fictitious surface that has an area, emissivity and temperature giving about the same heat transfer from the surfaces as the real multisurface case. In the

modified mean radiant temperature method, which was specifically developed for this investigation, the actual mean radiant temperature values obtained from the experimental measurements are utilised to estimate the average temperature of the surrounding surfaces of the test chamber.

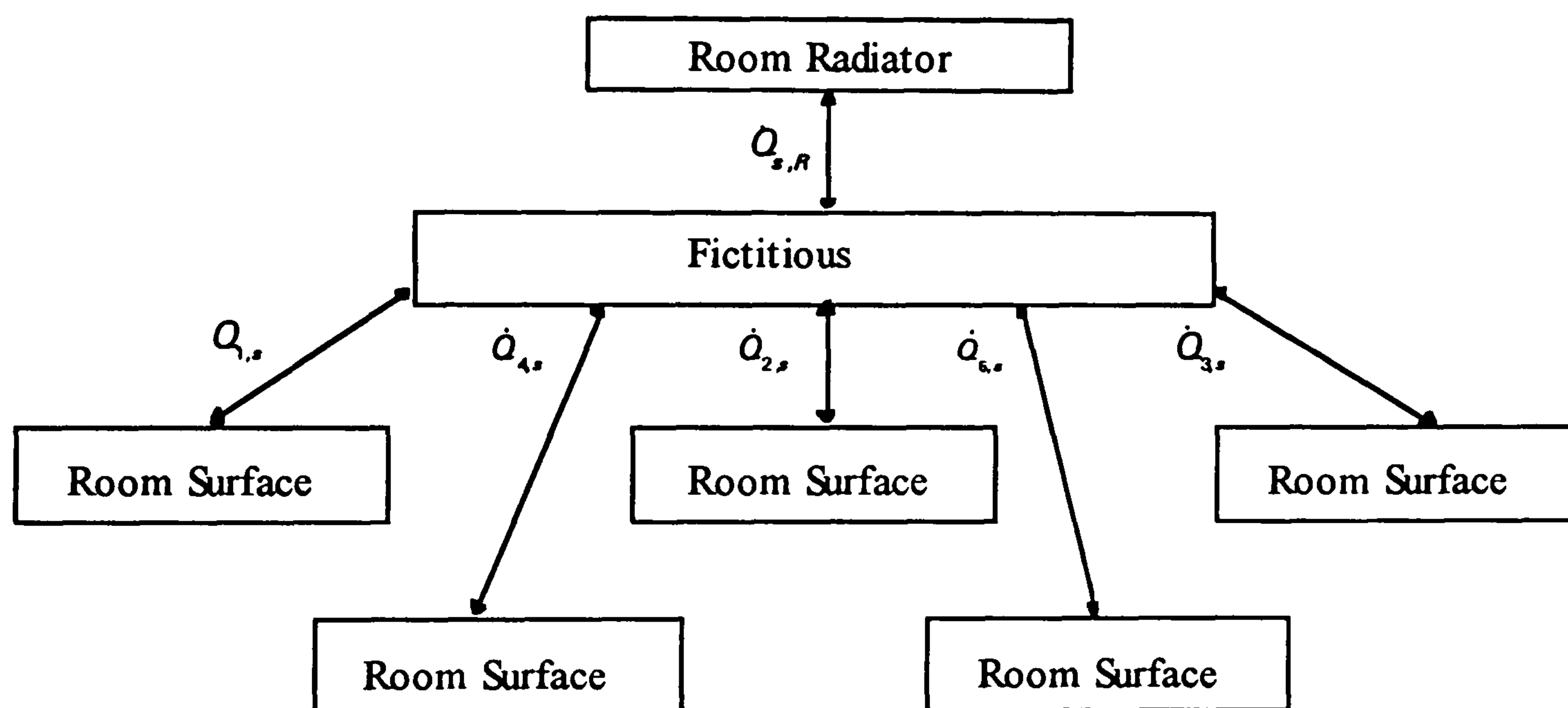

Figure 3.3 *Radiant heat transfer of the radiator using the two-surface approximation*

An approximation of the mean radiant temperature is defined [Fanger,1970], [Bansal,1994] in terms of the area weighted average surface temperature of the whole enclosure, which is

$$T_{mrt} = \frac{\sum_{j=1}^n A_j T_j}{\sum_{j=1}^n A_j} \quad 3-6$$

This definition will give substantial errors when used in practice as most rooms do not have uniform geometry and temperatures. However for the simple geometric construction of the test chamber, the mean radiant temperature may be closely approximated by the area emissivity weighted temperature of all the surfaces including the radiator, i.e.,

$$T_{mrt} = \frac{\sum_{j=1}^n A_j \epsilon_j T_j}{\sum_{j=1}^n A_j \epsilon_j} \quad 3-7$$

By definition, the numerator and the denominator can be expressed respectively, as

$$\sum_{j=1}^n A_j \epsilon_j T_j = \sum_{j \neq R}^n A_j \epsilon_j T_j + A_R \epsilon_R T_R \quad 3-8$$

and

$$\sum_{j=1}^n A_j \epsilon_j = \sum_{j \neq R}^n A_j \epsilon_j + A_R \epsilon_R \quad 3-9$$

Substituting these expressions into equation 3-7, and re-arranging gives

$$\left(\sum_{j \neq R}^n A_j \epsilon_j + A_R \epsilon_R \right) T_{mrt} = \sum_{j \neq R}^n A_j \epsilon_j T_j + A_R \epsilon_R T_R \quad 3-10$$

Further re-arranging and dividing both sides of the equation by the emissivity weighted total surface area without the radiator gives

$$\frac{\left(\sum_{j \neq R}^n A_j \epsilon_j + A_R \epsilon_R \right) T_{mrt} - A_R \epsilon_R T_R}{\sum_{j \neq R}^n A_j \epsilon_j} = \frac{\sum_{j \neq R}^n A_j \epsilon_j T_j}{\sum_{j \neq R}^n A_j \epsilon_j} \quad 3-11$$

The right hand side of the equation is the area emissivity weighted average temperature of all surfaces without the radiator. The radiant heat transfer equation between two surfaces can be written as

$$\dot{Q}_r = \sigma F_r A_{eff} (T_s^4 - T_R^4) \quad 3-12$$

with T_s as the surface temperature of the fictitious surface given by an area emissivity weighted average of all surfaces other than the radiator. Substituting the expression on the left hand side of equation 3-11 into equation 3-12 gives

$$\dot{Q}_r = \sigma F_r A_{eff} \left\{ \left[\frac{\left(\sum_{j \neq R}^n A_j \epsilon_j + A_R \epsilon_R \right) T_{mrt} - A_R \epsilon_R T_R}{\sum_{j \neq R}^n A_j \epsilon_j} \right]^4 - T_R^4 \right\} \quad 3-13$$

and F_r is a *modified* view factor for two-surface radiation heat exchange, expressed as

$$F_r = \left[\frac{1}{F_{s-R}} + \left(\frac{1}{\varepsilon_R} - 1 \right) + \frac{A_R}{A_s} \left(\frac{1}{\varepsilon_s} - 1 \right) \right]^{-1} \quad 3-14$$

The radiation view factor from the fictitious surface to the radiator could be assumed 1.0, for a flat plate.

Hence, the radiator heat extraction rate by radiation can be expressed using the two-surface approximation model with the area-emissivity weighted mean radiant temperature of equation 3-13. The viability of this model and its accuracy is tested by comparing the values obtained in the experiments with the theoretical model.

3.3.2 Convective Heat Transfer

For the purposes of evaluating the convective heat transfer component of the overall heat exchange, the radiators are treated as a series of closely spaced vertical parallel plate channels from their geometric configuration (see **Figure 3.1**). Chilled water is introduced into the radiator through the lower horizontal pipe from one side, passing through each plate and going out from the upper pipe at the other end. Water temperature gradually increases with distance from the water entry point. There are no dividers within the radiators tested. The radiator is assumed to be a series of symmetrically isothermal channels with the average radiator surface temperature taken as the mean of the radiator water inlet and outlet temperatures.

Natural convective heat transfer from the surrounding air to the radiator surface occurs as the boundary layer of the air is cooled by the chilled radiator surface resulting in density gradients, creating convective currents induced by the gravitational force.

The boundary layer developed is initially laminar. Transition to a turbulent boundary layer begins at a certain distance from the top end of the radiator, depending on the temperature difference between the radiator surface and the air. For the parallel plate channel configuration of the radiators, boundary layers develop on the opposing surfaces which may eventually merge to yield a fully developed flow condition.

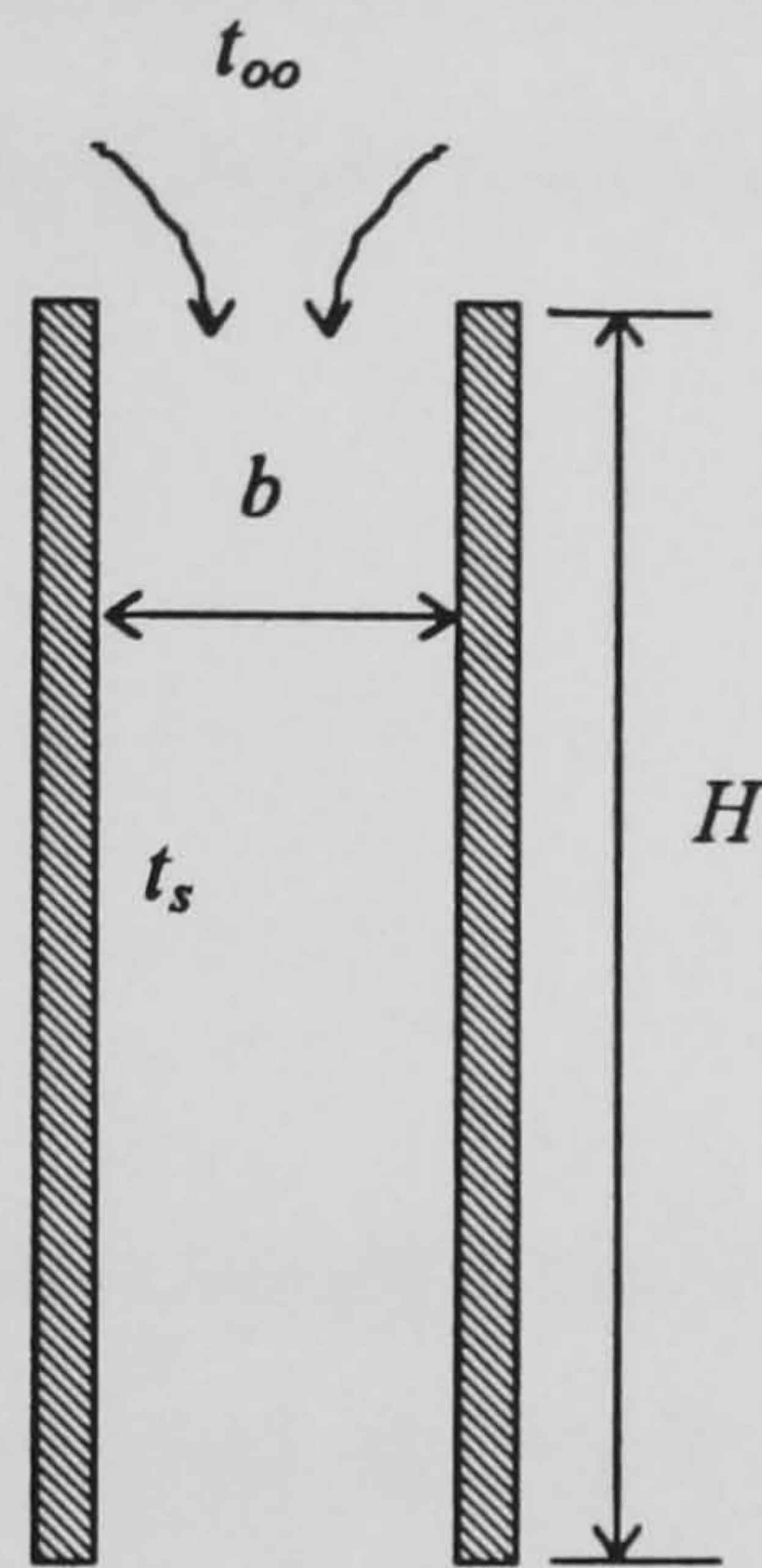

Figure 3.4 Schematic of the isothermal parallel plate channel

For this investigation, the average convective heat transfer coefficient is evaluated by employing empirical correlations obtained for similar geometric constructions.

The convective heat transfer rate for an isothermal parallel plate channel is dependent on both the height, H of the radiator and the distance of separation, b of each flat tube (see **Figure 3.4**). The convective heat transfer for short widely spaced plates can be expected to approach values associated with isolated plates in infinite media, while heat transfer from tall, closely-spaced plates can be considered analogous to that encountered in fully developed flow within channels. Therefore, relations for the isolated plate limit and the fully developed limit can be used to bound the Nusselt numbers over the complete range

of H/b values. The intermediate values of the Nusselt number can be obtained by using semi-empirical formulations for smoothly varying functions.

Since the local fluid (air) temperature is difficult to determine explicitly, the relevant properties are evaluated at average temperatures between the surfaces of the radiator and the ambient temperature, taken at a distance of 0.9 m from the radiator at a height of 1.1 m.

$$T_{ave} = \frac{(T_{\infty} + T_m)}{2} \quad 3-15$$

The Rayleigh number which correlates the occurrence of the relative magnitude of the gravitational and viscous forces in the fluid, is defined in terms of the distance of separation between the parallel plate tubes.

$$Ra_b = \frac{g\beta(T_{\infty} - T_m)b^3}{\alpha\nu} \quad 3-16$$

The average Nusselt number is defined as

$$N\bar{u} = \frac{\bar{h}_c b}{k} \quad 3-17$$

For symmetrically isothermal channel configurations, limiting expressions for an isolated plate and a fully developed flow have been empirically obtained by Elenbaas [1942].

$$N\bar{u} = 0.53 \left(Ra_b \frac{b}{H} \right)^{0.25} \quad \text{for small } H/b \text{ values} \quad 3-18$$

and

$$N\bar{u} = \frac{1}{24} \left(Ra_b \frac{b}{H} \right) \quad \text{for large } H/b \text{ values} \quad 3-19$$

Applying the approach to heat transfer in parallel plate channels by Churchill and Usagi [1972], the two expressions can be appropriately summed to obtain an approximate composite relation covering a wide range of H/b values. The average Nusselt number for symmetrically isothermal plates could then be expressed as

$$N\bar{u} = \left\{ \left(\frac{1}{24} Ra_b \frac{b}{H} \right)^{-n} + \left[0.53 \left(Ra_b \frac{b}{H} \right)^{0.25} \right]^{-n} \right\}^{-\frac{1}{n}} \quad 3-20$$

Experimental data from Elenbaas [1942] reveal that satisfactory agreement for all thermal configurations can be obtained with exponent $n=2$ in the composite relation. More recently, Bar-Cohen and Rohsenow [1984] presented a similar correlation applicable to the complete range of b/H , for symmetrically isothermal conditions, and the average Nusselt number can be obtained from

$$N\bar{u} = \left\{ \left[\frac{576}{\left(Ra_b \frac{b}{H} \right)^2} \right] + \left[\frac{2.87}{\left(Ra_b \frac{b}{H} \right)^{\frac{1}{2}}} \right] \right\}^{-\frac{1}{2}} \quad 3-21$$

The convective heat transfer of the radiator could then be expressed in the general form as

$$\dot{Q}_c = \bar{h}_c A (t_\infty - t_m) \quad 3-22$$

3.3.3 Condensation Heat Transfer

Dropwise Condensation Heat Transfer

In order to understand the latent heat transfer component during cooling, the heat transfer phenomenon associated with the effects of dropwise condensation was studied. There have been numerous investigations concerning dropwise condensation due to its relatively high heat transfer rate compared to filmwise condensation [*Lefevre,1965*], [*Citakoglu,1968*], [*Collier,1972*], [*Hannemann and Mikic,1976*], [*Rose,1981*], [*Griffiths,1983*].

However, the mechanism governing this phenomenon still does not seem to be completely clear and depending on various assumptions and approximations, contradictory statements are common. For example, the mean heat flux on a condensing surface can be theoretically obtained from steady state calculation of the heat transfer through individual drops and a steady distribution of drop sizes. However, in reality, coalescence of droplets is constantly occurring, and the process is extremely unsteady.

Past research on dropwise condensation has been mainly concerned with high condensation rates in high temperature environments, due to its engineering applications in condensing distillates. Very little work has been done on condensation in the presence of non-condensing gases, which is the case for condensing water vapour in the presence of air, and at typically ambient temperatures i.e. between 18 and 28°C.

Therefore, the calculation of heat transfer rates through individual droplets by determining their size and distribution seems to be inappropriate for the purposes of this investigation.

Analogy between Heat and Mass Transfer

The latent component of the radiator heat transfer occurs because water vapour diffuses from the air to the radiator surface where it condenses. Analogy relations for convective mass transfer have been developed for many heat transfer applications involving both heat and mass transfer. The similarity of mass, heat and momentum transport in a turbulent and laminar boundary layer is utilised, for example with the Reynolds analogy, which gives a correlation between friction factors and heat transfer coefficients where $Pr \approx Sc \approx 1$. For a wider range of values of Pr and Sc , Chilton and Colburn developed a correlation of heat transfer data with friction data known as the *j-factor* analogy.

The driving force for convective heat transfer is the dimensionless temperature gradient. Similarly, the concentration or density gradient acts as the driving force for the mass transfer mechanism. The latent component of the heat transfer (as the water vapour diffuses from the air to the radiator surface where it condenses), can be expressed in terms of the difference between the saturated mass ratio of humidity at the condensing surface and the humidity mass ratio of the air. The condensation rate can be described by the equation

$$w = h_d(x_w - x_\infty) \quad 3-23$$

with

$$h_d = \rho_a h_m \quad 3-24$$

The latent heat transfer rate is then expressed as

$$\dot{Q}_{lat} = h_m \rho_a (x_w - x_\infty) h_{fg} A \quad 3-25$$

Assuming that the dimensionless relations that govern thermal boundary layer behaviour is the same as those that govern concentration boundary layer, the relations of the Nusselt and Sherwood numbers are analogous.

$$Nu = f(Pr, Re) \quad 3-26$$

$$Sh = f(Sc, Re) \quad 3-27$$

The Nusselt number Nu is the dimensionless temperature gradient at the surface, describing a measure of the convection heat transfer occurring at the surface, and the Sherwood number Sh is the dimensionless concentration gradient at the surface describing the measure of the convection mass transfer occurring at the surface. The Nusselt and the Sherwood numbers are generally proportional to Pr^n and Sc^n where the exponent n is a positive value less than 1. The analogy between the convective heat and mass transfer problems enable the determination of the mass transfer coefficient in terms of the convective heat transfer coefficient obtained for a particular surface geometry, by replacing the Nu with the Sh and the Pr with the Sc . It follows that

$$\frac{Nu}{Pr^n} = \frac{Sh}{Sc^n} \quad 3-28$$

and

$$\frac{hLk^{-1}}{Pr^n} = \frac{h_m LD^{-1}}{Sc^n} \quad 3-29$$

From the definition of the Lewis number Le , which is a non-dimensional parameter defined as the ratio between the thermal and the mass diffusivities

$$Le = \frac{Sc}{Pr} = \frac{\alpha}{D} \quad 3-30$$

and re-arranging, gives

$$\frac{h}{h_m} = \frac{k}{DLe^n} = \rho c_p Le^{1-n} \quad 3-31$$

with $n=1/3$, Sc and Pr being 0.6 and 0.7 respectively over the range of usual room temperatures. The heat and mass transfer coefficient can be described using the Lewis relation by the equation:

$$\frac{h_c}{h_m} = 0.9 \rho c_p \quad 3-32$$

Equation 3-32 is considered valid for air and water vapour at low mass transfer rates.

Therefore the latent component of the radiator heat extraction rate can be expressed in terms of the convective heat transfer coefficient by substituting the expression for h_m from equation 3-32.

$$\dot{Q}_{lat} = \frac{h_c}{0.9 c_p} (x_w - x_\infty) h_{fg} A \quad 3-33$$

Using empirical correlations for heat transfer coefficients, it is convenient to use the Lewis relationship to determine the mass transfer coefficient from calculated values of the convective heat transfer coefficients. However, the analogy is based on ideal surface and flow conditions. The condensate droplets 'roughens' the radiator surface and may lead to erroneous results. The reliability of the boundary layer analogy with the Lewis relation is tested in the experiments.

3.4 Conclusion

The theoretical models of the heat exchange mechanisms between the radiator and its surroundings in the form of radiation, convection and condensation were formulated. The sensible heat transfer occurs by radiation from the surrounding surfaces and by free convection from the surrounding air. The latent heat transfer occurs by condensation to the radiator surface when it is brought below the dew point temperature of the surrounding air.

$$\dot{Q} = (\dot{Q}_c + \dot{Q}_r)_{sens} + \dot{Q}_{lat}$$

- The theoretical model of the radiant component of the radiator heat extraction rate involves an accurate estimation of the individual view factors to the radiator, with accurate values of the room surface temperatures. A separate method based on the two-surface approximation model using the mean radiant temperature data obtained from the experimental measurements was developed. This two-surface model will be compared with the theoretical model in the experimental study.
- The convection model was based on the assumption that the radiator is a series of vertical isothermal parallel plate channels. Empirical correlations for this geometric construction are dependent on both the height of the radiator and the distance of separation of the flat tubes.
- The theoretical model of the condensation heat transfer is formulated by using the boundary layer analogy using the Lewis relation for heat and mass transfer. Since the condensation droplets cause the surface of the radiator to become 'rough', possible uncertainties to the validity and accuracy of the relation can be expected. The convective heat and mass transfer coefficients calculated from this model will be carefully compared with the values derived from the results of the experimental tests.

4 Experimental Investigation

4.1 Introduction

The theoretical model put forward in Chapter 3 is tested in an experimental chamber by measuring the heat removal rate of the radiator under controlled environmental conditions. The experimental apparatus is described, followed by the methodology taken.

Despite the importance of the radiant component of the heat exchange by room radiators, little investigation on this matter has been reported. European Standards [EN,1996] reveal a table of the proportion of the radiant component of heat transfer values for different types of room radiators for the heating regime, however they seem to be crude approximations, mainly for the purpose of calculating pressure correction factors [EN 442-2] and inconclusive in terms of the actual heat transfer rate by radiation of the radiators. A recent study in Japan [Yoshino,1996] utilised a radiant heat flux meter to enable the instant measurement of radiant output of radiators in the heating regime, independently of the radiator surface emissivity or surface temperature distribution. According to this method, the radiant component of the total output of the radiator was measured to be 10 - 20% higher than predicted values of thermal radiation based on Hottel's theory for radiation exchange in an enclosure, even when emissivity was set to 0.95 for the radiator surface.

The radiant heat transfer rate to the radiator is obtained by substituting the measured mean radiant temperature into the modified mean radiant temperature model. The aim of the experimental investigation was to obtain a better understanding of the radiator heat transfer characteristics including the convective and condensation aspects when used for cooling and dehumidification.

4.2 Description of the Experimental Rig

4.2.1 Test Chamber

The test chamber used for the testing of the radiators was located on the ground floor in the internal area of the main building of the School of Mechanical Engineering at Cranfield University. The walls were of brick construction and ceiling constructed from plaster board with outer insulation consisting of 100 mm. glass wool. The internal location of the chamber, shielded it from any effects of solar radiation, and assured constant environmental conditions once steady-state was achieved. 40 mm. of styrofoam insulation was added to all the internal walls and to the ceiling of the test chamber in order to ensure an uniform radiant environment.

The test chamber was climatically controlled via an air-conditioning rig. The chamber was divided into the air circulation buffer zone and the actual test zone by a fine nylon mesh sheet. Conditioned air was slowly circulated within the buffer zone which then gradually infiltrated the actual test zone (see **Figure 4.1**). By separating the buffer zone and the actual test space in this manner, stable and uniform conditions were achieved in the test zone while limiting the effects of the incoming air such as any air velocity disturbances to a minimum. Complete recirculation of the conditioned air kept constant air pressure within the test zone. This proved to be a simple but effective method of controlling the environmental conditions in the test zone utilising the air-conditioning rig without causing air velocity disturbances.

The temperature and humidity of the air in the buffer zone were accurately controlled by a plant controller (*manufacturer: Satchwell, Type IAC 600 - Universal Multi-Loop Intelligent Advanced Controller*) which was specifically configured for this system via its '*Bubbleland*' software package. A steam humidifier supplied steam into the supply duct of the air-conditioning rig. The volume of air circulation in the buffer zone was manually set at a constant rate by a speed controller on the fan.

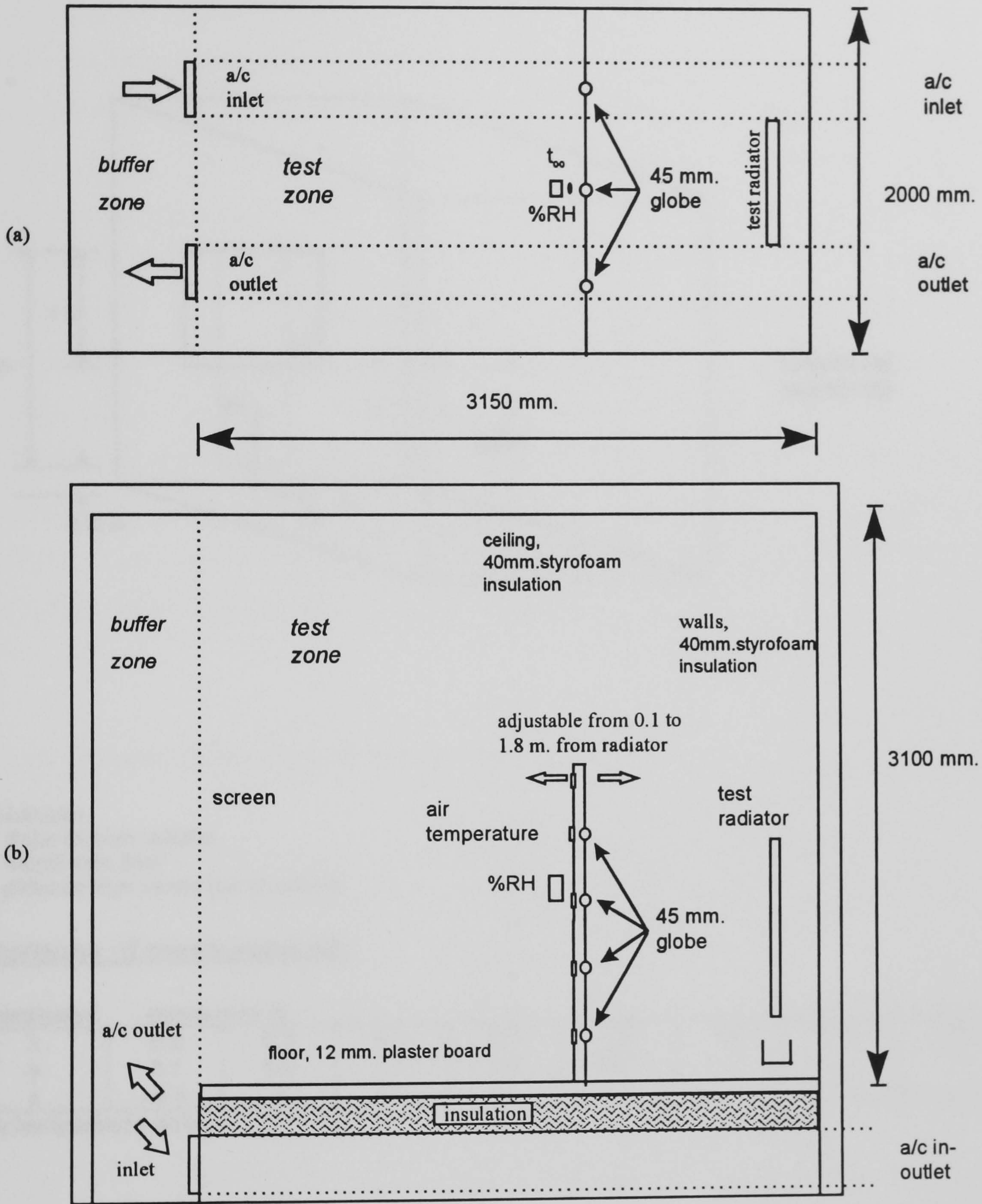
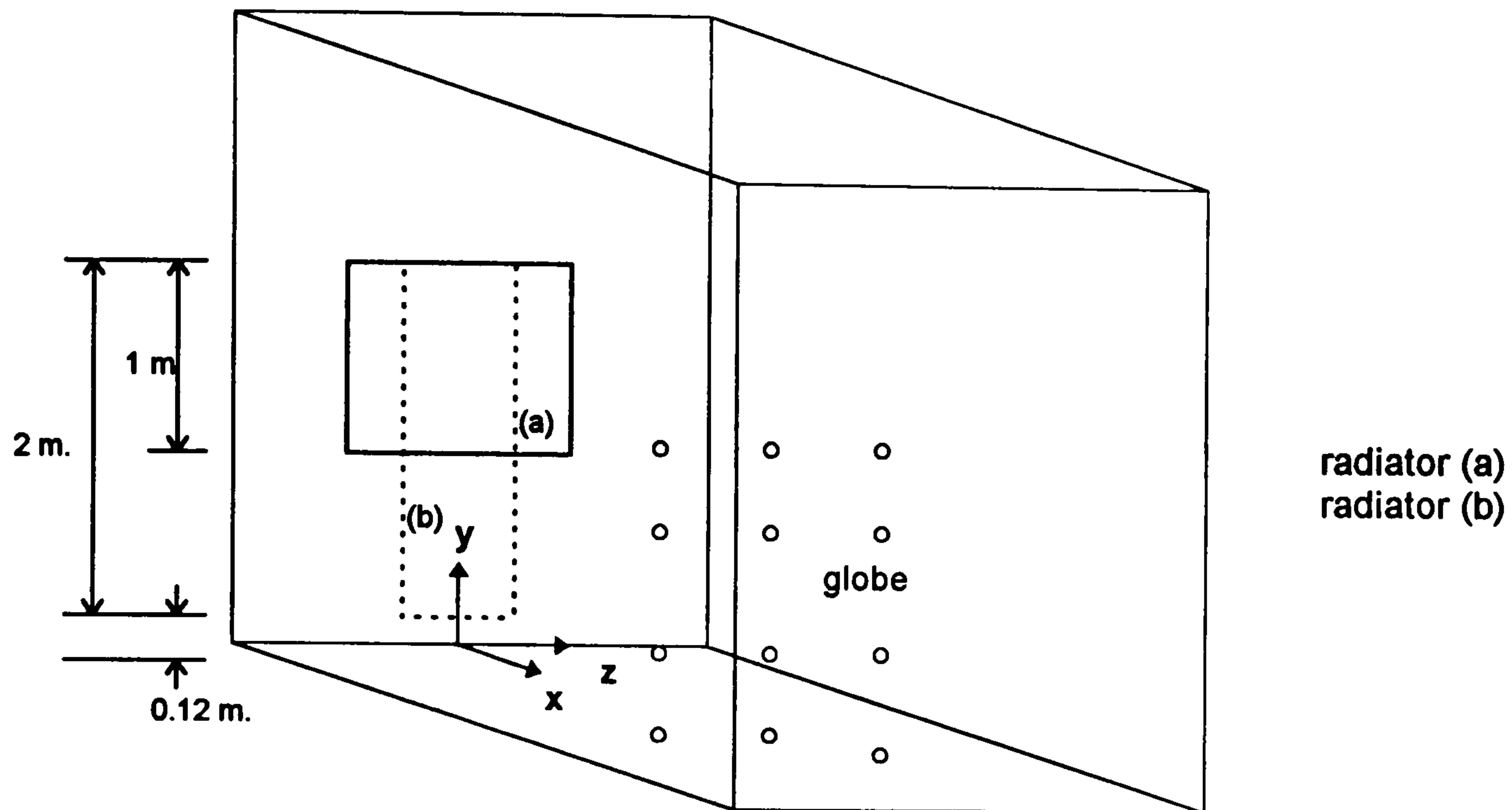

Figure 4.1 Schematic diagram of the experimental chamber - (a) floor plan (b) cross-section



coordinates:

x - distance from radiator

y - height from floor

z - distance from centre line of radiator

Positions of measurements

coordinates	distance in m.							
x	0.2	0.3	0.5	0.7	0.9	1.2	1.5	1.8
y	0.1	0.5	1.1	1.6	2.0*			
z	-0.5	0	0.5					

*air temperature only

Figure 4.2 *Points of measurements in the test chamber in relation to the radiators (a) and (b) (relative humidity was measured at height 1.1 m. only)*

In the test chamber, the air temperatures were measured using radiation-shielded thermocouples positioned at heights (y-axis) of 0.1, 0.5, 1.1, 1.6, and 2.0 m above the floor. Radiation-shielded thermocouples were also used to measure the internal surface temperatures including the ceiling, walls and the floor. The surface temperatures of the ceiling and the walls were taken at representative points at the centre of the room, while floor surface temperatures were taken at 0.3, 0.6, 1.2 m. from the edge of the radiator. Relative humidity of the room air was measured at a height of 1.1 m. Air velocity measurements were made using a hot wire anemometer (*manufacturer:Solomat, type:129MS*). Polyethylene black globes with a diameter of 45 mm. were used to measure globe temperatures. The size of these globes enabled relatively quick response time for measurements, which was between 15-20 minutes to reach equilibrium. The measurements were made between distances of 0.2 and 1.8 meters from the radiator surface. The positions of measurements taken for the different parameters of the room air are indicated on **Figure 4.2**.

4.2.2 Radiator and Chilled Water Circuit

The shape of the steel radiators utilised for this investigation are shown **Figure 3.1**. Chilled water is introduced from the lower horizontal pipe, passing through each flat vertical tube and exits from the top horizontal pipe at the other end. The outer surface of the radiator was double-coated in standard white paint as it would be in normal heating applications. Each radiator was tested separately in a test chamber under strict climate-controlled environments. The radiator dimensions are presented in **Table 4.1**.

Table 4.1 *Dimensions of the radiators, in meters*

	Radiator (a)	Radiator (b)
Length, L , [m]	1	0.5
Height, H , [m]	1	2
Width, w , [m]	0.07	0.07
Distance between pipes, b , [m]	0.05	0.05
number of vertical pipes	20	10
Surface area, A [m^2]	3.29	3.19
Effective surface area, A_{eff} [m^2]	2.3	2.3
<i>for radiation calculations</i>		
(L x H x w)		

The water circuit diagram is shown in Fig. 4.3. In order to attain stability of the inlet water temperature, an insulated buffer tank (75 litres) was installed between the chiller unit and the radiator, which proved effective at maintaining constant water temperature, well within the sensor error margin of $\pm 0.2^\circ\text{C}$. The water flow transducer which produced a linear pulse output proportional to the total volume of flow monitored any fluctuations of the water flow rate during the measurements.

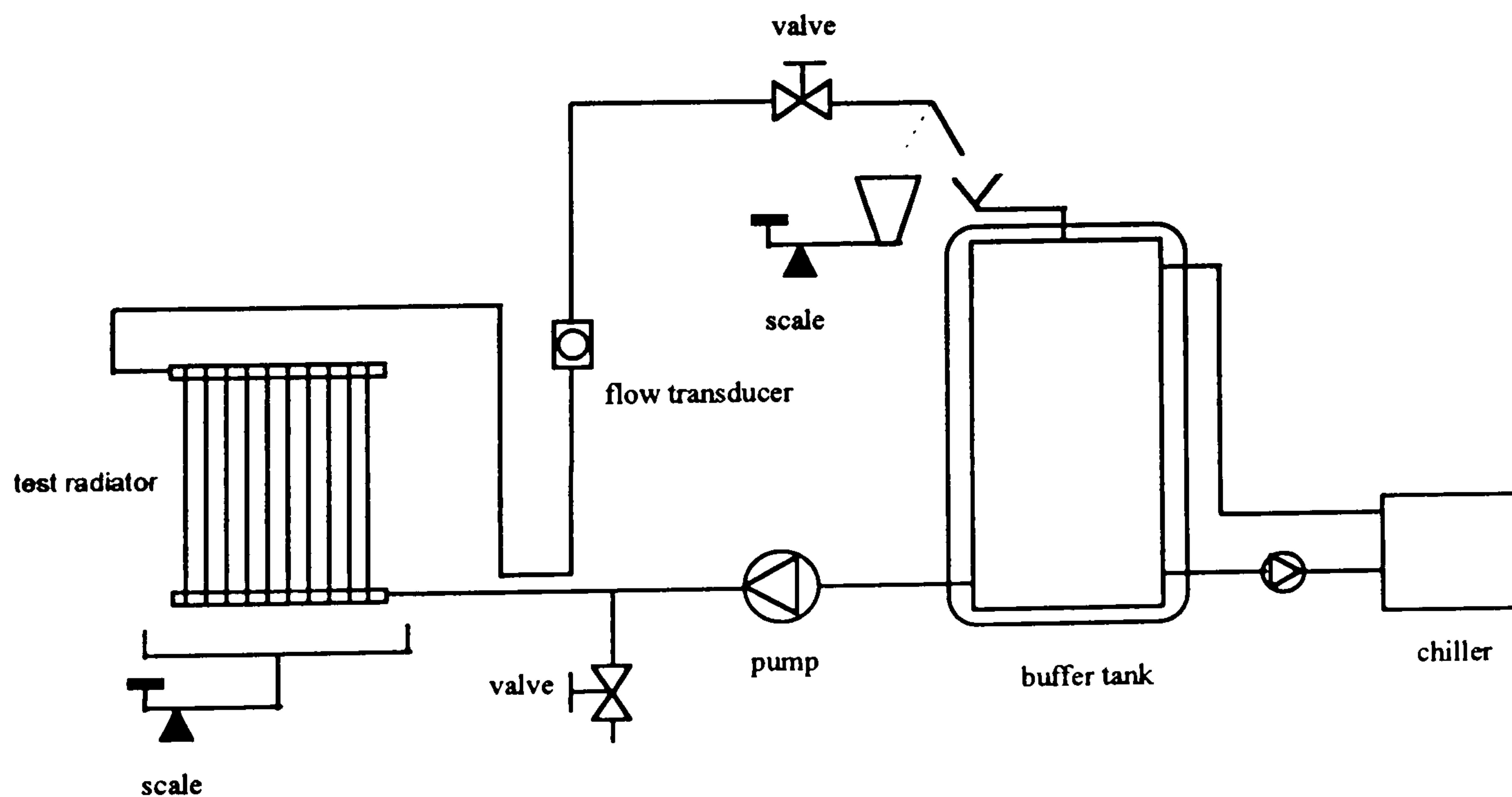
**Figure 4.3** *Schematic diagram of the chilled radiator test operation*

4.2.3 Sensors and Data Logging

The thermocouples used were calibrated by placing them in a stirred ice water mixture before measurements were made. The humidity transmitter (*manufacturer: Rotronic, Type HTWI-200*) was calibrated according to manufacturers instructions. The accuracy and correct functioning of the water flow transducer (*manufacturer: Opella, TypeC grey*) were verified before each measurement by weighing the actual water flow rate into a bucket for a 1 minute duration followed by a 5 minute duration after each test. The thermistors utilised for the water temperature measurements were calibrated by the manufacturer prior to installation. The sensor characteristics utilised in the experiments are presented in **Table 4.2**.

Table 4.2 *Sensor characteristics after calibration*

Measurement Means	Application	Uncertainty
Thermocouple (type T)	air temperature	$\pm 0.1^{\circ}\text{C}$
Thermocouple (type K)	globe temperature	$\pm 0.1^{\circ}\text{C}$
Platinum resistance thermometer	air temperature	$\pm 0.1^{\circ}\text{C}$
Lithium Chloride cell	relative humidity	$\pm 1.5\%$
Thermistor (type UUT)	water temperature	$\pm 0.2^{\circ}\text{C}$
Flow transducer	water flow rate	$\pm 1.5\%$ linearity
Hot wire anemometer	air velocity	$3\% \pm 0.1 \text{ ms}^{-1}$
Scale	weight	

For the recording and storage of data, a fully programmable data logging device (*manufacturer: Delta-T Devices, type Delta-T vers.3.03*) was used.

4.3 Experimental Methods

4.3.1 Procedure

The experimental investigation on the heat transfer characteristics of the radiators were performed by

1. measurement of the actual heat removal rate of the radiator under steady state conditions in the test chamber
2. measurement of the globe temperatures at various distances from the radiator in the test chamber to determine the mean radiant temperature distribution
3. measurement of the condensation rate under steady state conditions

The actual heat removal rate of the radiator is the product of the mass flow rate and the enthalpy difference between the water inlet and outlet points of the radiator. Hence the total heat removal rate is defined as

$$\dot{Q} = \dot{m}(h_o - h_i) = \dot{m}c_p(t_o - t_i) \quad 4-1$$

The radiators (a) and (b) (see **Figure 3.1** and **Table 4.1**) were independently placed in the chamber at 0.12 m. above the floor and separated from the wall by a distance of .045 m., and additionally at 1.12 m. above the floor with radiator (a).

It was assumed sufficient to consider the test chamber to be in a steady state condition when the air and globe temperatures did not fluctuate more than $\pm 0.2^\circ\text{C}$, and the relative humidity remained within $\pm 3\%$, for a minimum of 20 minutes, observed through trial and error. The steady-state condition for the radiator circuit was assumed when water temperature stabilised within $\pm 0.2^\circ\text{C}$, and the water flow rate remained constant for a minimum of 20 minutes.

For the wet regime i.e. when the water temperature was brought below the dew point of the room air and condensation formed on the radiator surface, the steady state condition of the condensation process was additionally examined through visual inspection of the radiator surface. Initially, when the radiator surface was cooled below the dew point of the ambient air, the first condensation droplets formed on its surface. Theoretically, condensate droplets may act as resistance to heat transfer of the radiator surface. The droplets gradually increased in size, coalesced with nearby droplets, and finally slid down the radiator surface due to gravity, merging with more droplets along their path. The accumulation of condensation droplets in the collection pan placed below the radiator reached a constant rate only when the condensing surface reached a 'steady' condition. Furthermore, the surface area available for the formation of condensation droplets were relatively more unstable during transition phases, i.e. when system parameters had been altered. Therefore measurements at steady state conditions of the condensation process on the radiator surface were vital in order to collect accurate data.

The experiments were performed for room conditions based on a measurement reference point at a distance of 0.9 m. from the centre of the radiator and at height 1.1 m. in the test chamber. The reference room air temperature was varied between 25, 26, 27 and 28°C with the room relative humidity ranging between 50 and 80%. The radiator surface temperature was varied by setting the chiller control point between 7 and 19°C.

The water flow rates for the radiator were determined by trial operation at various mass flow rates. The performance of radiators in general is dependent on the mass flow rate of the transfer medium up to a certain point from beyond which little further increase in heat transfer may be expected. By testing the heat transfer rate at varying water flow rates, the optimum point was attained, which was used for the tests.

The measurement of the condensation rate on the radiator surface was performed by collecting the condensate at the radiator base, which was then weighed after a period of time after steady state conditions were observed.

4.3.2 Calculation of the Individual Heat Transfer Rates from the Experimental Data

Mean Radiant Temperature Calculation

The mean radiant temperature is defined as ‘the temperature of a uniform enclosure with which a small black sphere at the test point would have the same radiation exchange as it does with the real environment’ [Parsons, 1993]. Using the equations from *ISO7726 (1985)*, it can be calculated using the globe temperature, air temperature and velocity values obtained from the experimental measurements. For low air velocity, $v \leq 0.15 \text{ ms}^{-1}$

$$t_{mrt} = \left[(t_{gl} + 273)^4 + \frac{0.25 * 10^8}{\varepsilon} \left(\frac{|t_{gl} - t_a|}{d} \right)^{0.25} (t_{gl} - t_a) \right]^{0.25} - 273 \quad 4-2a$$

and for $v > 0.15 \text{ ms}^{-1}$,

$$t_{mrt} = \left[(t_{gl} + 273)^4 + \frac{1.1 * 10^8 v^{0.6}}{\varepsilon * d^{0.4}} (t_{gl} - t_a) \right]^{0.25} - 273 \quad 4-2b$$

with the emissivity $\varepsilon=0.95$ for the black globe, and $d=45 \text{ mm}$. for the diameter of the globe.

Calculation of the Heat Transfer Rate by Radiation

The measurement method of the radiant output of room radiators has been developed for standards in Japan, i.e. *JIS A 4004*. However the discrepancies between the

theoretical values and measured data from this method have been reported to be significant [Yoshino,1996]. For example, radiant outputs obtained from the measurements were 10 - 20% higher when the radiator and the surrounding surface emissivities were assumed at 0.95, and 15 - 25% higher when the emissivities were assumed at 0.9, compared to values obtained by Hottel's radiation theory.

The heat extraction rate by radiation from the radiator was assessed using the two-surface model and the measured mean radiant temperature derived from the experimental results. This value was compared with the theoretical values obtained using equation 3-2.

The area-emissivity weighted approximation of the mean radiant temperature in the model is independent of location and orientation in a room. In the test chamber, the mean radiant temperature values vary depending on the proximity to the radiator, as seen in a sample measurement in **Figure 4.4**. In order to reflect the mean radiant temperature value in the model, the measured data at a distance of 0.9 m. from the radiator is assumed to be the representative value of the mrt in the room.

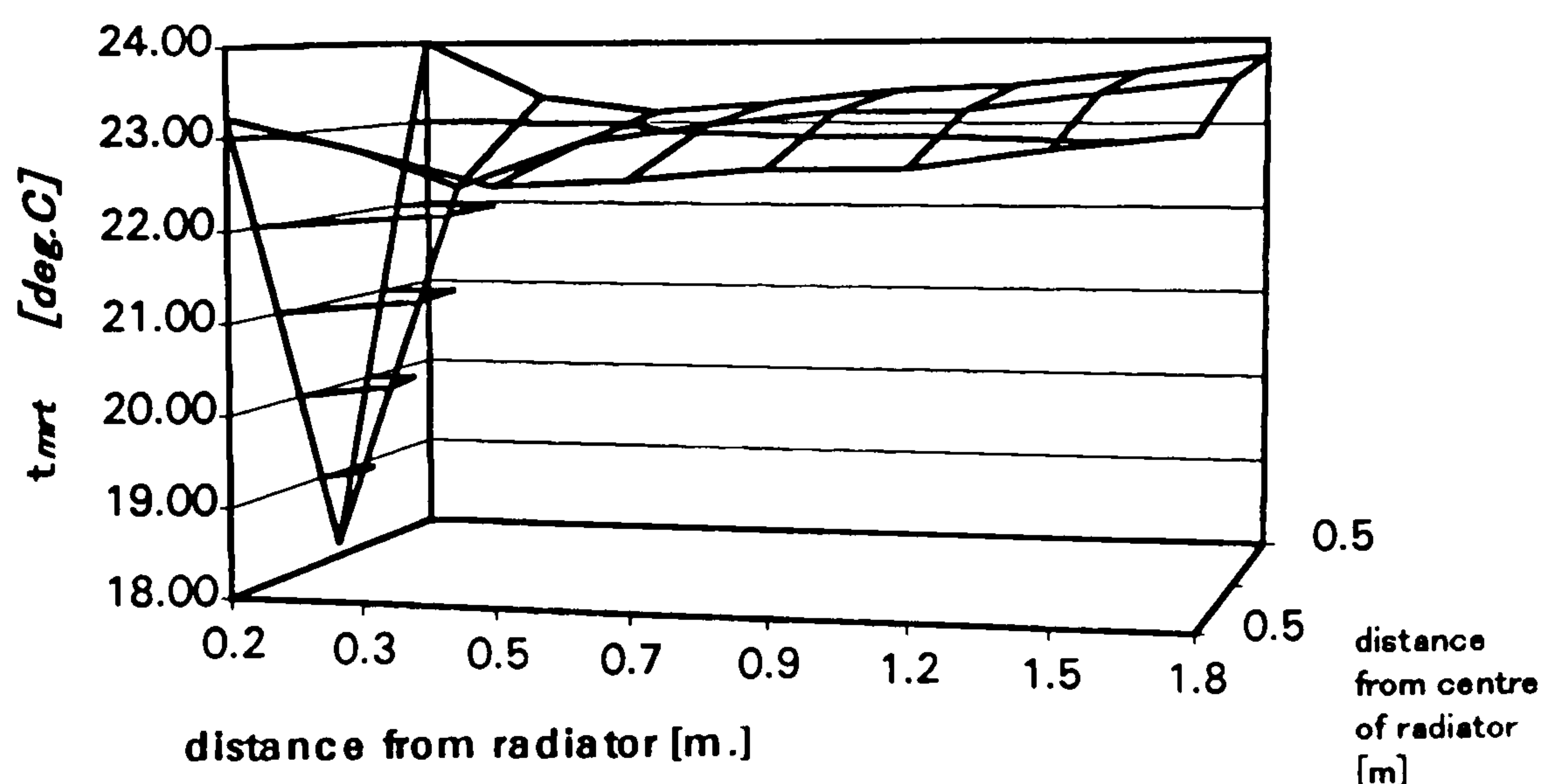

Figure 4.4 Mean radiant temperature distribution in the test chamber with radiator surface temperature at 10°C

Calculation of the Latent Component of the Heat Extraction Rate

The latent heat transfer rate was calculated as the product of the measured rate of condensation on the radiator surface and the latent heat of condensation at the radiator surface temperature.

$$\dot{Q}_{lat,m} = Wh_{fg} \quad 4-3$$

The latent heat transfer rate obtained from the condensation rate measured in the experiments were compared with the values deduced from the mass and heat transfer analogy using the Lewis relation.

Calculation of the Convective Component of the Heat Extraction Rate

The convective heat transfer component was deduced by subtracting the radiant and latent heat transfer components from the total measured heat transfer rate. As a measure of comparison, alternative empirical values for the average convective heat transfer coefficients were calculated by using the measured condensation rates from the experiments and the Lewis relation for heat and mass transfer analogy.

4.4 Conclusion

The experimental rig and procedure used for the testing of the radiator heat transfer characteristics were described.

The radiation heat transfer component is calculated based on the two-surface approximation model presented in Chapter 3. The latent heat transfer component is obtained from the measured condensation rates on the radiator surface. Finally, the convective heat transfer component is deduced from the difference between the measured total heat transfer rate and the sum of the radiant and latent heat transfer rates. Empirically obtained values of the convective heat transfer coefficients were calculated by using the measured condensation rates and the mass and heat transfer analogy via the Lewis relation. This implies that the results of the convective heat transfer coefficients obtained experimentally will be dependent on the reliability of the Lewis relation. The individual component data will be tested and compared with the measured total heat transfer rate and the predicted models from Ch.3 (see Table 4.3).

Table 4.3 Comparison of predicted and measured values

	<i>Theoretical Model</i>	<i>Experimental Results</i>
Q_r	Radiator - Room surface model	Two-surface approximation method based on measured t_{gl}
Q_c	Symmetrically isothermal vertical parallel plate channels	1) $Q_{total} - Q_r - Q_{lat}$ 2) Calculated from the condensation rates via the Lewis relation
Q_{lat}	Boundary layer analogy via the Lewis relation	Calculated from measured values of condensation rates to the radiator
Q_{total}	Sum of Q_r , Q_c , Q_{lat} obtained theoretically	Calculated from measured values t_i , t_o , mass flowrate of water

5 Presentation and Discussion of Experimental Results

5.1 Introduction

The results obtained from the experimental tests described in Chapter 4 are presented. The overall heat extraction rates of radiator (a) and (b) are presented in Section 5.2. In Section 5.3, the results obtained in the experimental investigations and the values predicted from the theoretical models are compared, and individual components of the radiator heat transfer characteristics are discussed. The overall discussions follow in Section 5.4.

5.2 Heat Extraction Rates of the Radiators

The heat extraction rate of the radiator indicates the amount of heat energy removed by the radiators under steady-state conditions. The total measured heat extraction rate of radiator (a) (see Table 4.1) is shown in Figure 5.1a with the reference air temperature at 25°C. Similarly, the total heat extraction rates of radiator (a) with the reference air temperature at 27°C are shown in Figures 5.2a.

The total heat extraction rate is dependent on the mean temperature difference between the radiator surface and the ambient air. The characteristic line of the total heat extraction rate is drawn through the test points measured at different radiator surface temperatures with constant ambient conditions. Each line indicates the heat extraction rates under different humidity levels of the ambient air. The dotted line represents the sensible heat transfer rate where the radiator surface temperature is maintained above the dew point of the test room. The slope of the heat extraction rate increases when the radiator surface temperature reaches the dew point of the ambient air and condensation begins to form on the radiator surface. The heat extraction rates are plotted against the

mean surface temperatures of the radiator in **Figure 5.1b** and **Figure 5.2b** where the dew point of the air can be directly read from the point where the slope of the characteristic line changes. The tests, performed under constant reference air temperature with different moisture contents in the air, indicate that the radiator heat extraction rates are strongly influenced by the humidity level of the ambient condition, when condensation occurring.

Similarly the total heat extraction rates of radiator (b) (see **Table 4.1**) is shown in **Figure 5.3a**, with the reference air temperature at 25°C. **Figure 5.3b** shows the heat extraction rates plotted against the mean surface temperatures of the radiator. The total heat extraction rates of both test radiators are shown in **Figure 5.4**. The results for radiator (a) with a height of 1 m. and radiator (b) with a height of 2 m. show that the overall heat extraction rates are between 10 and 17% higher for the shorter radiator (a) than for the taller radiator (b). The differences increase as the radiator surface temperature is lowered. The total surface areas available for heat transfer for radiator (a) is 3% higher at 3.29 m² than the 3.19m² for radiator (b), due to the longer horizontal connection pipes for radiator (a). Theoretically, the shorter radiator would have a higher heat transfer rate due to the following reasons, aside from the negligible difference in the overall surface area available for heat transfer.

- Radiator (a) with double the number of flat tubes than radiator (b) available for convection, would have more air volume passing between the radiator tube channels.
- Longer air channels between the tubes for radiator (b) decrease the temperature difference between the radiator surface and the air, reducing the rate of heat transfer from the air to the radiator surface.

These issues will be further elaborated with the analysis of the individual heat transfer components in the following sections.

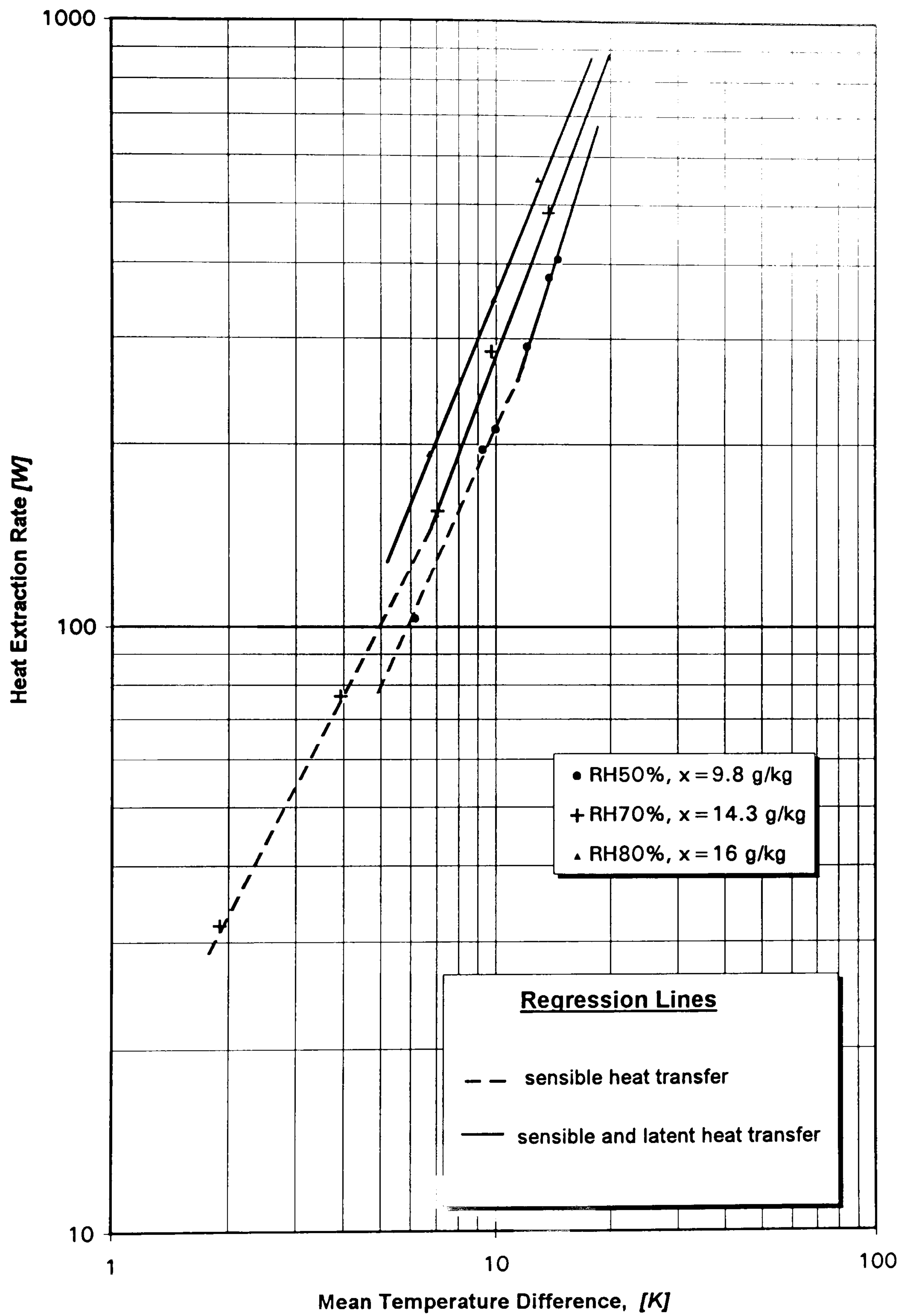

Figure 5.1a Heat extraction rate of radiator (a) as a function of mean temperature difference, with $t_{a,ref} = 25 \text{ deg C}$

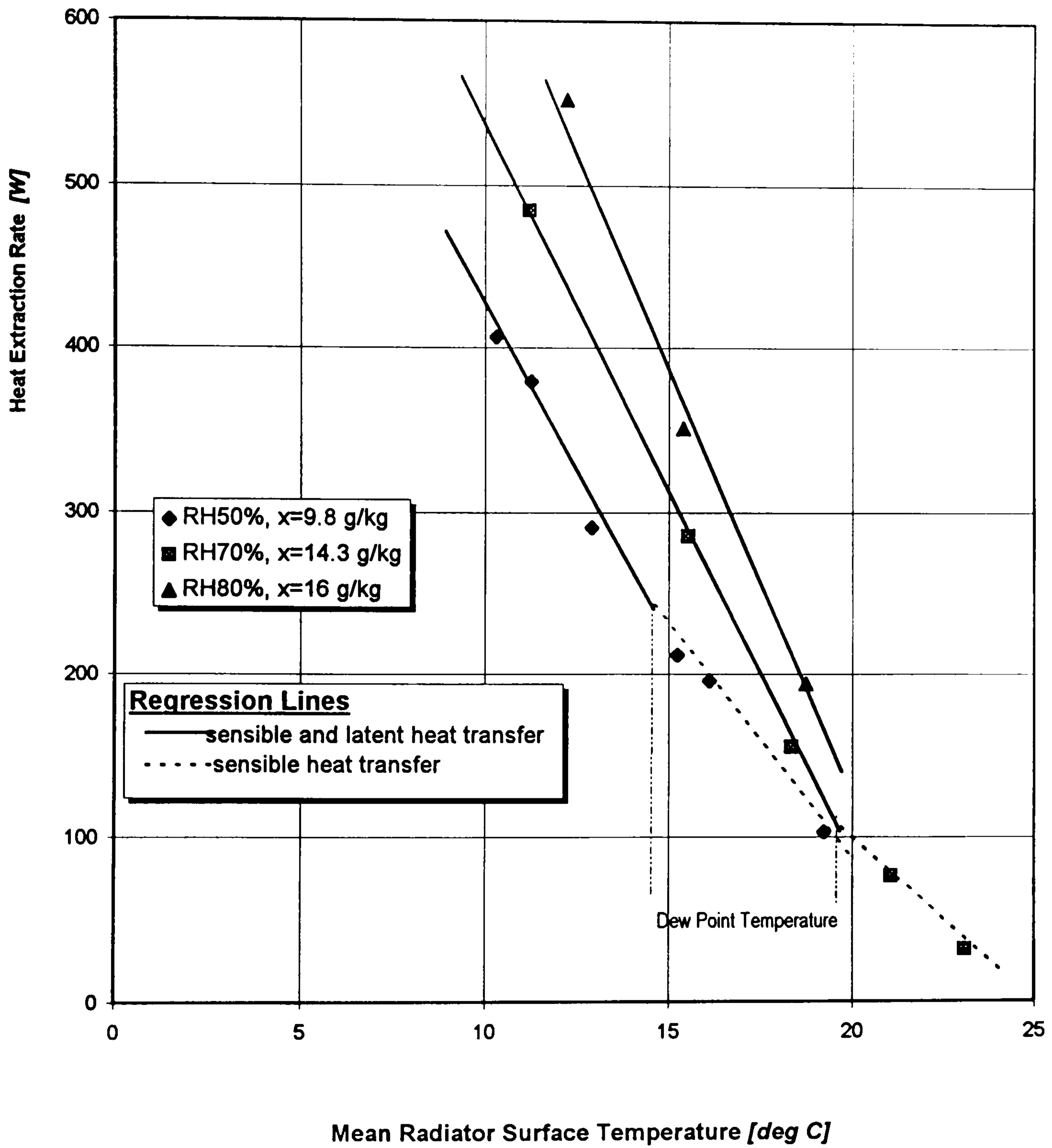

Figure 5.1b

Heat extraction rate of radiator (a) as a function of the mean radiator surface temperature with $t_{a,ref} = 25 \text{ deg C}$

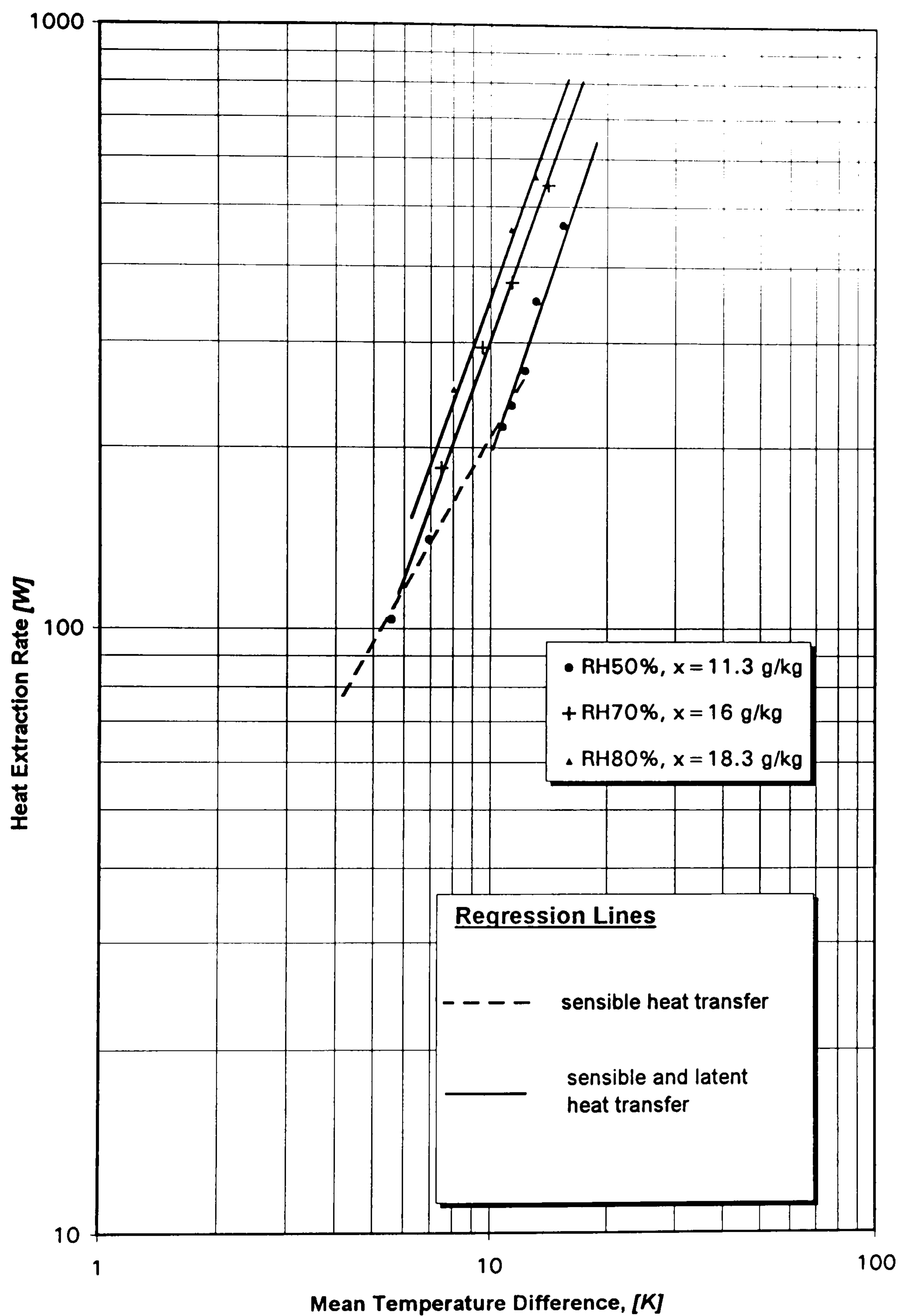

Figure 5.2a

Heat extraction rate of radiator (a) as a function of mean temperature difference, with $t_{a,ref}=27$ deg C

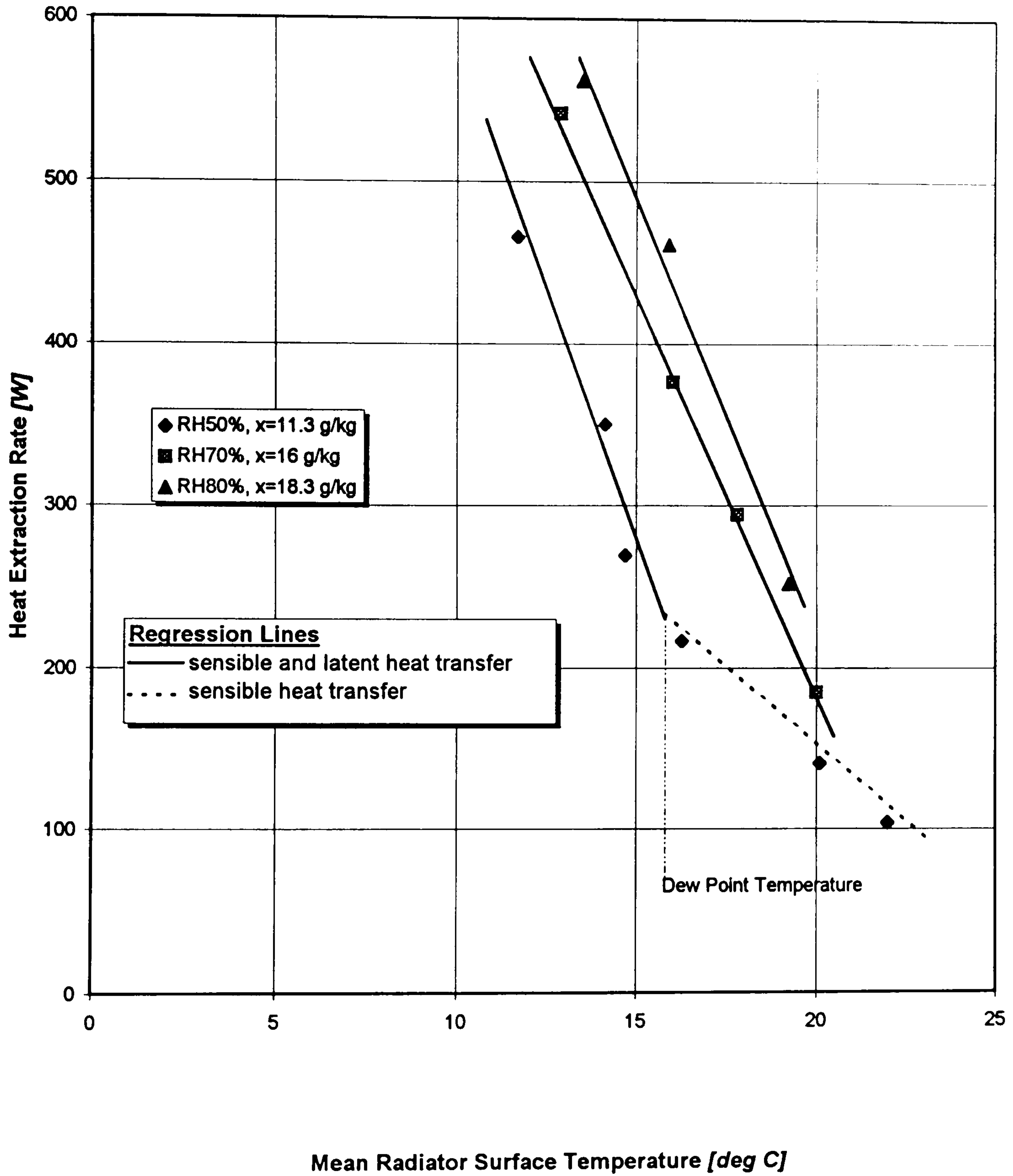

Figure 5.2b Heat extraction rate of radiator (a) as a function of the mean radiator surface temperature with $t_{a,ref}=27$ deg C

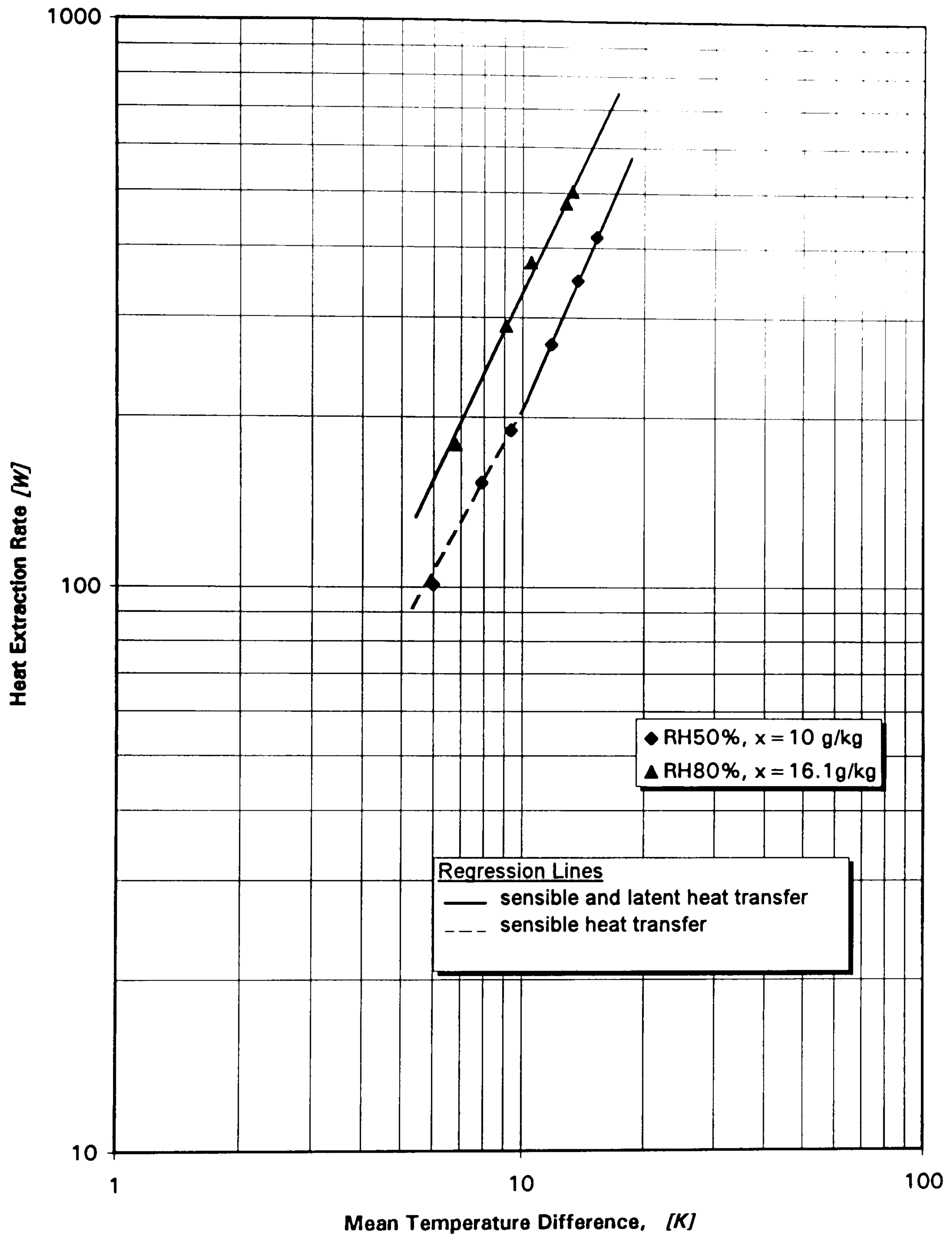

Figure 5.3a

Heat extraction rate of radiator (b) as a function of mean temperature difference, with $t_{a,ref} = 25 \text{ deg C}$

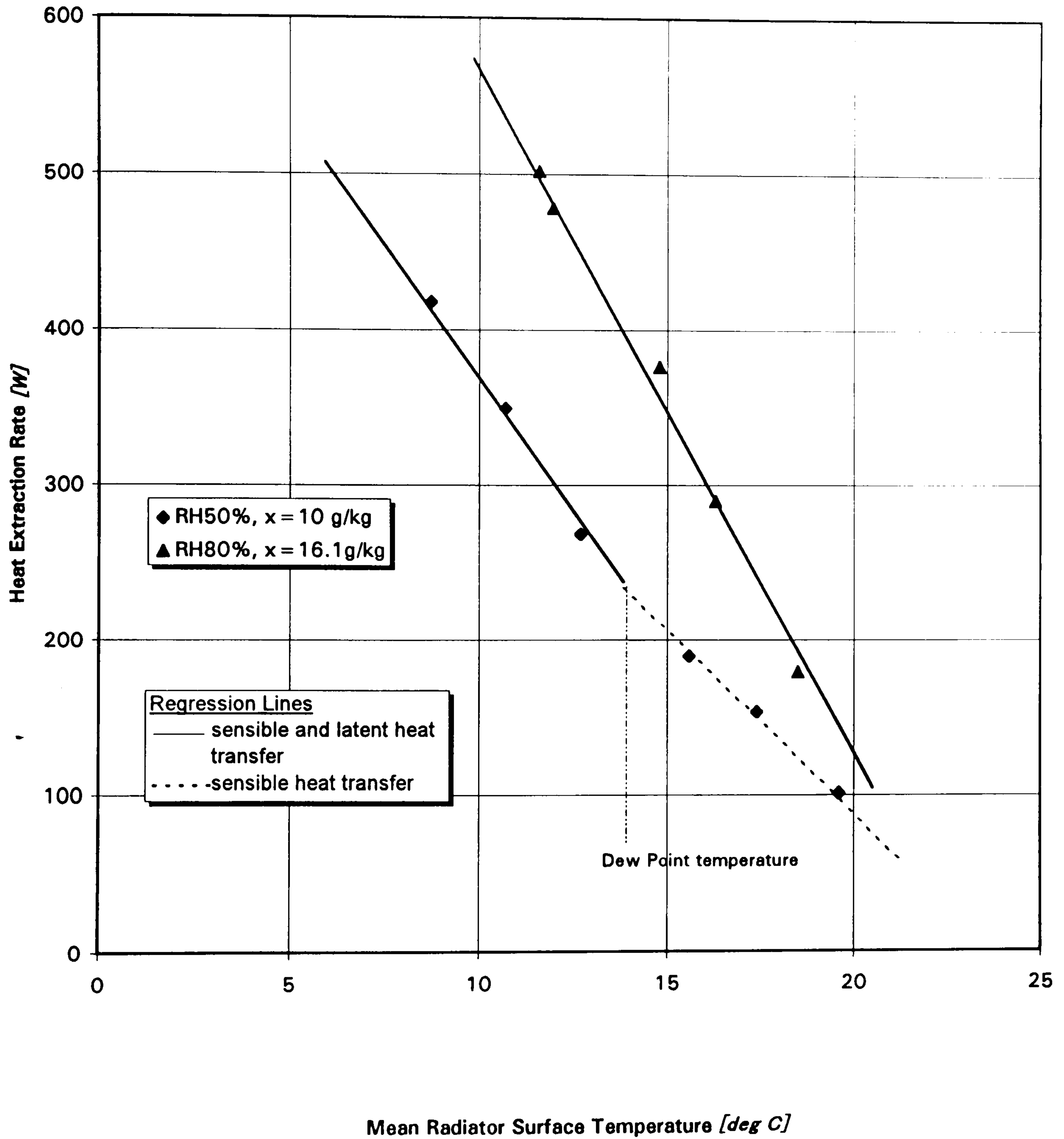

Figure 5.3b

Heat extraction rate of radiator (b) as a function of the mean radiator surface temperature, with $t_{a,ref} = 25 \text{ degC}$

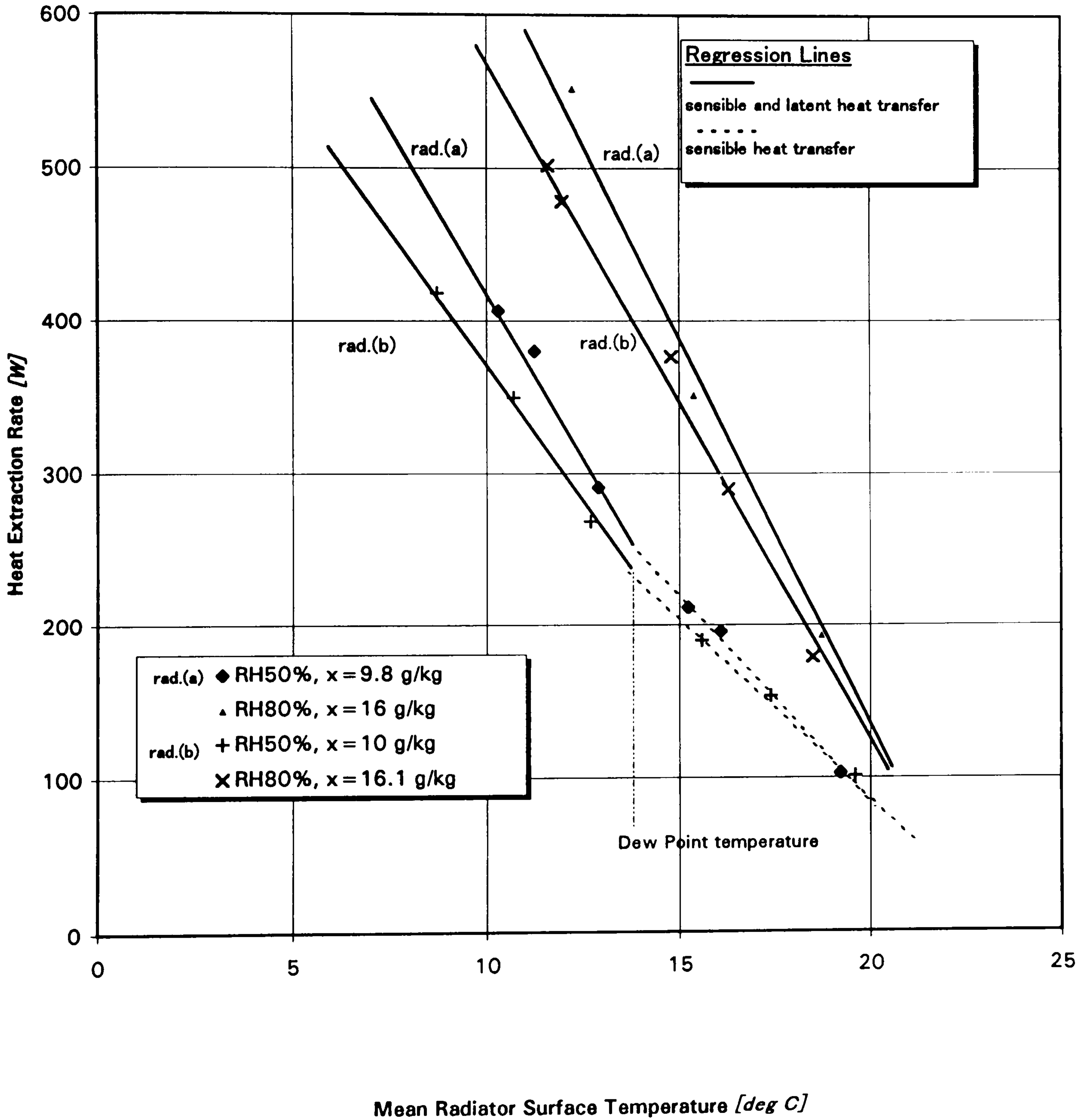

Figure 5.4

Heat extraction rate of radiators (a) and (b) as a function of the mean radiator surface temperature, with $t_{a,ref} = 25 \text{ degC}$

5.3 Comparison between Theoretical and Experimental Results

The total heat extraction rate of the radiator obtained theoretically in Chapter 3 is compared with the experimental results (see Figure 5.5). The theoretically predicted values tend to underestimate the actual heat removal rates at the higher heat transfer rates. The discrepancy widens as the heat transfer rate increases, and the tendency is particularly visible with radiator (b) in the wet regime. The differences may be due to the inaccuracies within any of the heat transfer models whether by radiation, convection or condensation. The individual components of heat transfer are discussed in the following sections in order to obtain a better understanding of the heat transfer characteristics of the radiator in the cooling and dehumidifying mode.

5.3.1 Heat Transfer Components of the Radiator

The proportions of the individual heat transfer components of radiant, convective and latent transfer due to condensation at the radiator surface are shown in Figures 5.6 to 5.8. The radiant component was calculated with the globe temperature data obtained from the experimental measurements and using the modified mean radiant temperature method based on the two-surface approximation method. The latent component was calculated using the measured amount of condensation on the radiator surface. In order to test the radiant and the latent heat transfer models directly from the experimental measurements, the convective component was deduced from the difference between the total measured heat transfer rate and the combination of the radiant and latent heat transfer components.

The results indicate that the radiant component is proportionally higher compared to the convective component when the temperature difference between the air and the mean radiator surface temperature is lower. When there is no condensation occurring on the radiator surface, the radiant proportion is constantly above 50%, reaching close to 70%, for radiator (b) at a temperature difference between the radiator surface and the air of 6

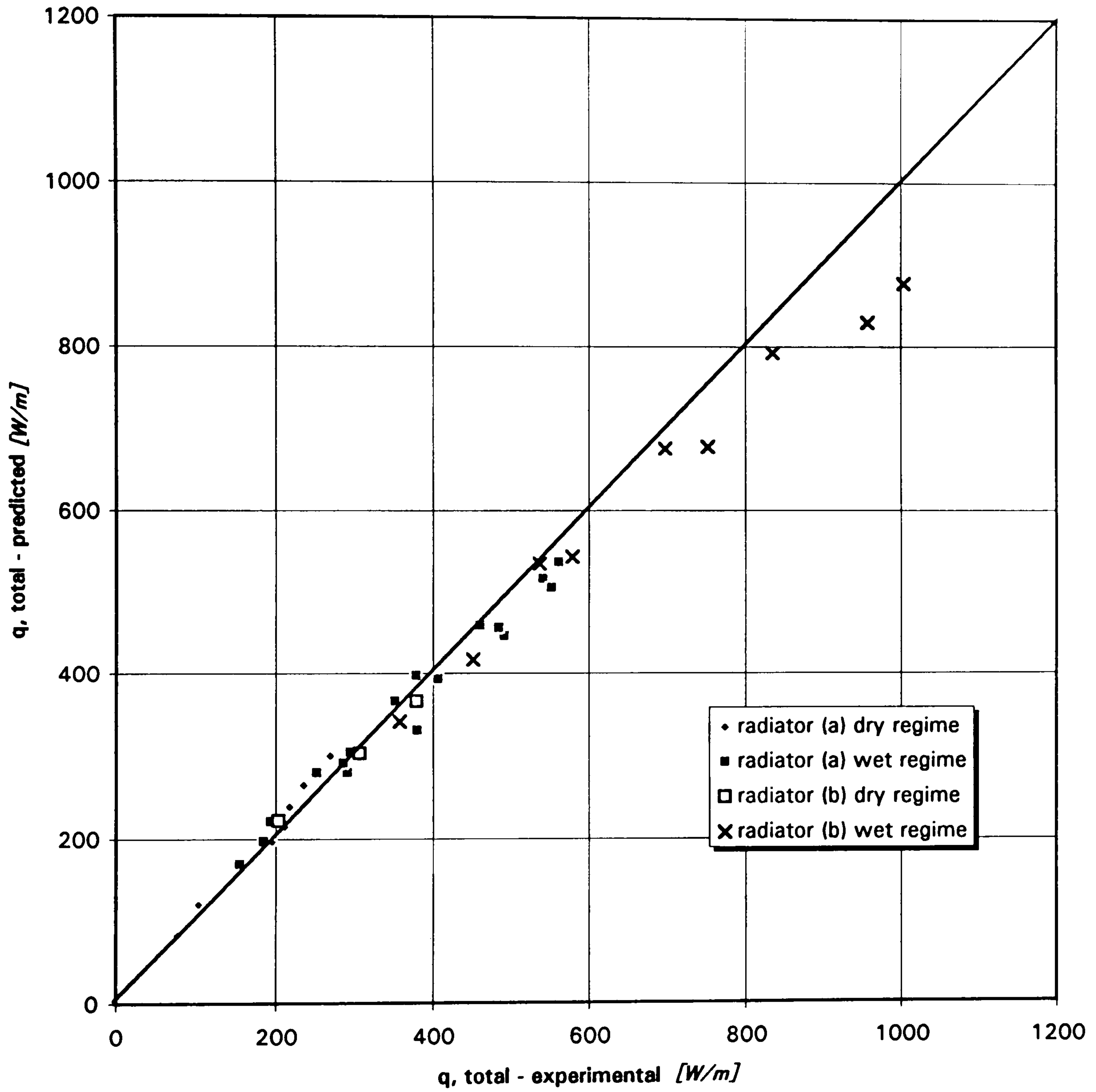

Figure 5.5

Comparison between theoretical and experimental total heat extraction rates

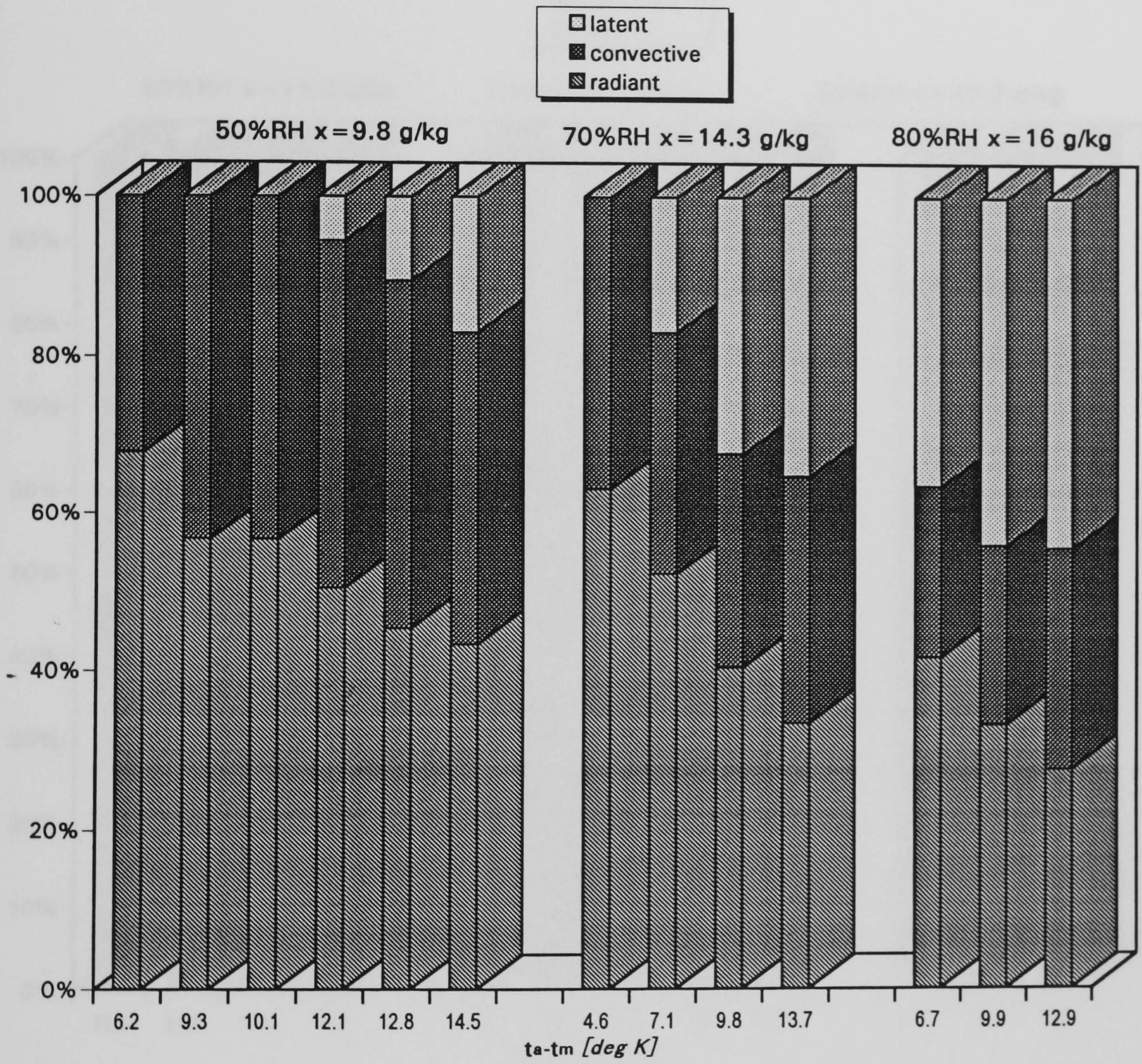

Figure 5.6

Proportion of heat transfer by radiation, convection and condensation, for radiator (a) with $t_{a,ref} = 25 \text{ degC}$

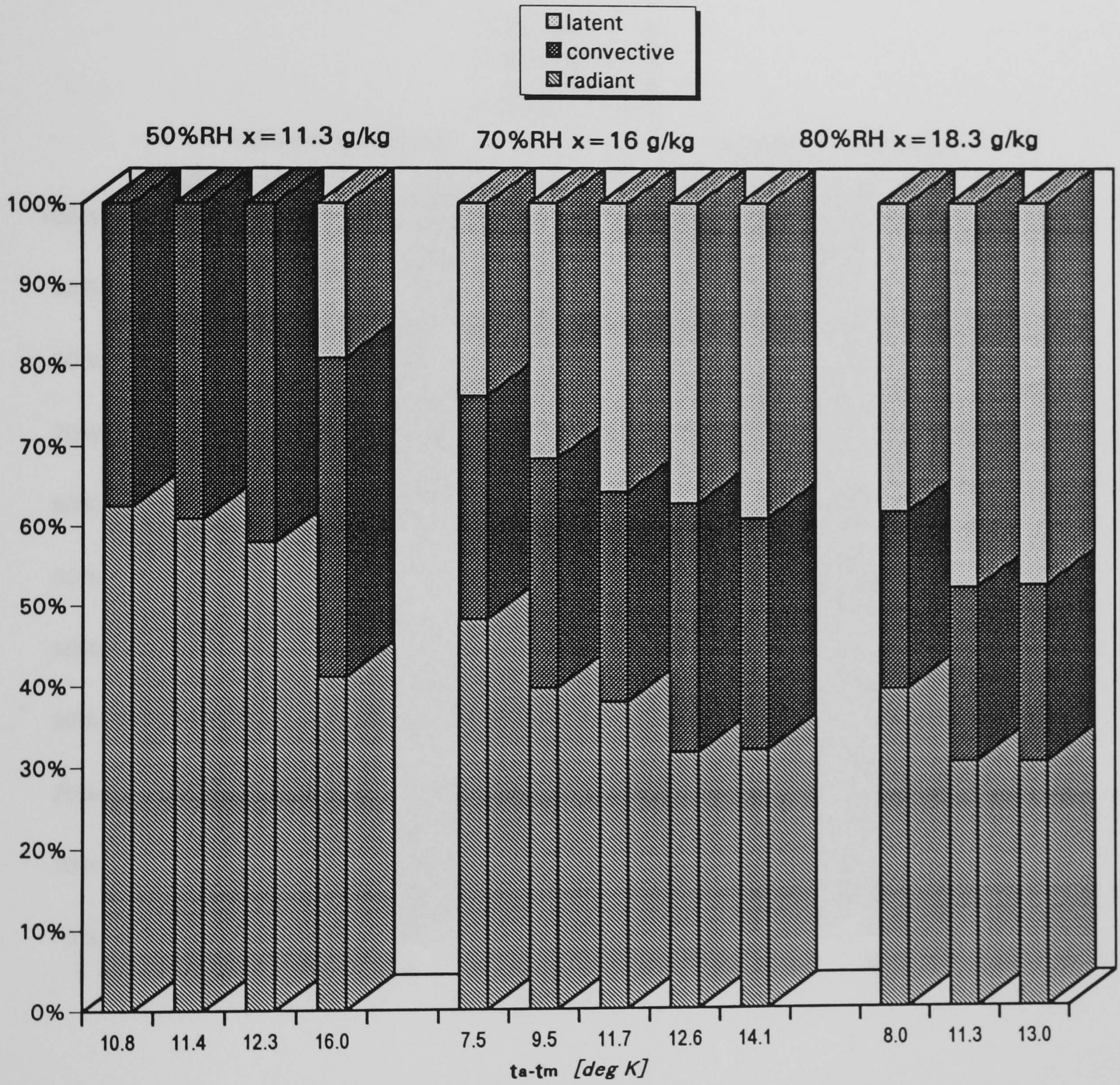

Figure 5.7 Proportion of heat transfer by radiation, convection and condensation, radiator (a)
 $t_{a,ref} = 27$ degC

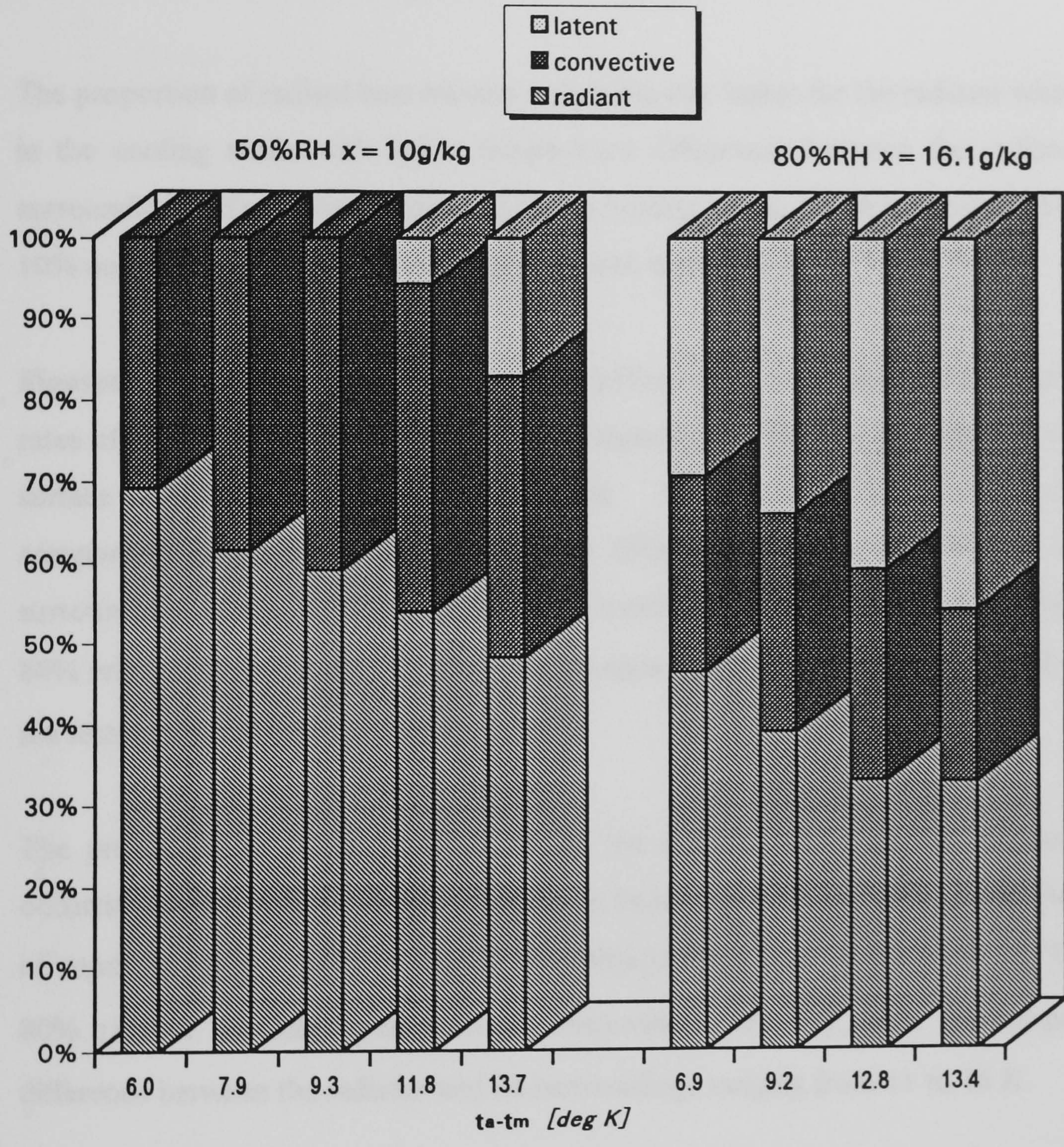

Figure 5.8

Proportion of heat transfer by radiation, convection and condensation, radiator (b)
 $t_{a,ref} = 25 \text{ degC}$

K (see **Figure 5.8**). This clearly indicates that the radiant property is more effective than the convective property of the radiator when the temperature difference between the radiator surface and the surrounding air is low. The temperatures of the surrounding surfaces in the test chamber are discussed in the following section where the globe temperature measurements are presented.

The proportion of radiant heat transfer is significantly higher for the radiator when used in the cooling mode with lower temperature differences between the radiator and surrounding surfaces than when used in the heating mode, which is generally between 10% and 50% of the overall heat exchange (see Section 3.1).

Figures 5.9 to 5.11 show the derived values of the individual component heat extraction rates of the radiators plotted against the temperature difference between the radiator surface and the air at the reference point. The magnitude of all the individual components increases as the temperature difference between the radiator and its surroundings increase. When the ambient conditions become highly humid, reaching 80% relative humidity at 27°C, the latent component significantly rises, especially when the temperature difference is above 10K.

The proportion of latent heat transfer to the radiator when there is condensation occurring on the radiator surface is shown to be between 6% and 48%, under the range of conditions tested, at 50% relative humidity (reference air temperature: 25 °C), and 80% relative humidity (reference air temperature: 27 °C), with the temperature difference between the radiator and its surroundings ranging from 11 to 16 K.

5.3.2 Heat Transfer by Radiation

The radiant heat extraction rate of the radiator derived from the experiments are compared with the predicted values from equation 3-2. Radiant heat transfer occurring

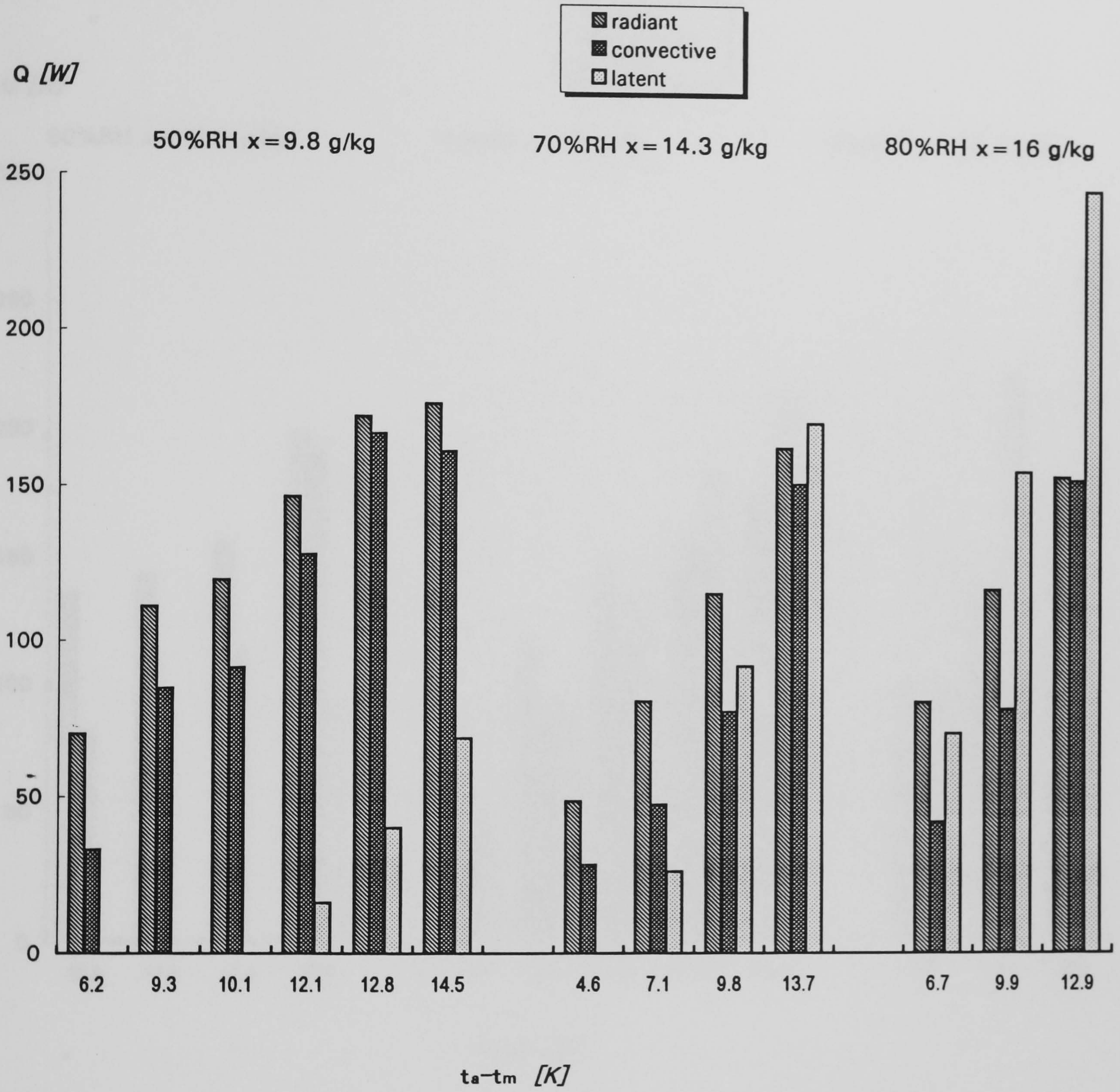

Figure 5.9

Heat extraction rates by radiation, convection and condensation, for radiator (a) with $t_{a,ref} = 25 \text{ degC}$

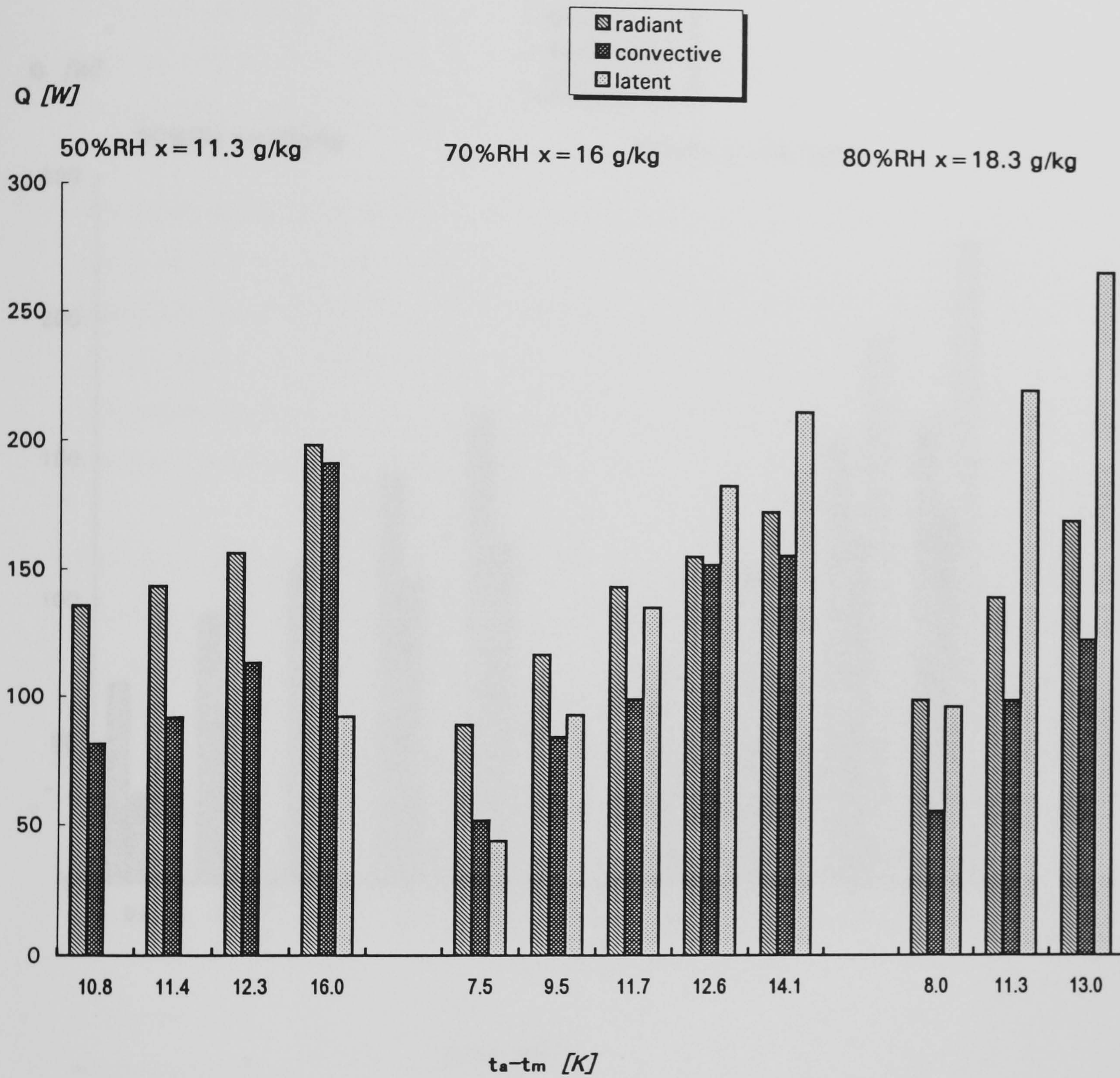

Figure 5.10

Heat extraction rates by radiation, convection and condensation, for radiator (a) with $t_{a,ref} = 27$ degC

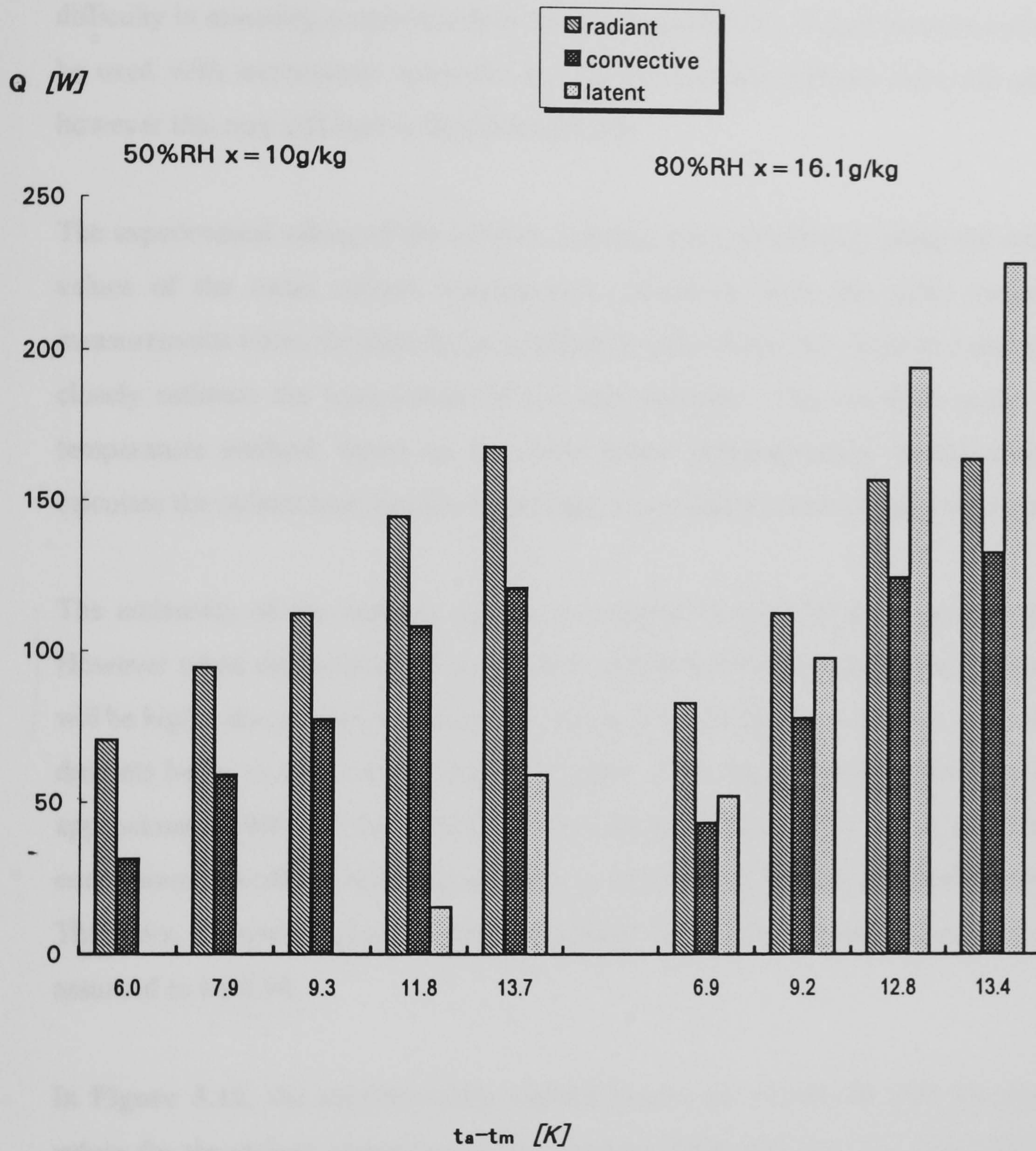

Figure 5.11

Heat extraction rates by radiation, convection and condensation, for radiator (b) with $t_{a,ref} = 25 \text{ degC}$

to the radiator surface is defined as the amount of radiation exchange occurring between the surrounding surfaces and the radiator surface. The difficulty of obtaining the radiant heat transfer values relating the area of floor close to the radiator was due to the difficulty in assessing a representative surface temperature. Representative values may be used with incremental measurements up to a certain distance from the radiator, however this may still lead to significant errors.

The experimental values of the radiant exchange were obtained by using the measured values of the mean radiant temperatures, calculated from the globe temperature measurements taken for each test at a reference point in the test room, in order to more closely estimate the temperature of the surroundings. The modified mean radiant temperature method, based on the 'two-surface approximation' model is used to calculate the radiant heat transfer occurring on the radiator surface using equation 3-13.

The emissivity of the radiator surface is assumed to be 0.92 for a painted surface. However when the surface is covered with condensation droplets, the emissivity value will be higher due to the water droplets, which have an emissivity of 0.96. Initially when droplets begin to form on the radiator surface, it has been visually observed to cover approximately 90% of the surface. When steady-state conditions are achieved, the continuous run-off of larger drops leave a dry surface free of condensing droplets. Therefore, the emissivity of the radiator surface when there is condensation occurring is assumed to be 0.94.

In **Figure 5.12**, the experimentally derived results are compared with the predicted values for the radiant component of heat transfer from equation 3-2. The radiant heat transfer values calculated from the mean radiant temperature measurements are between 4 and 7% higher than the predicted values.

The radiant heat transfer values which were derived from the experimental results depend on the values of the globe temperature measurements, taken at the reference point, which was 0.9 m. from the centre of the test radiator, at a height of 1.2 m. It is

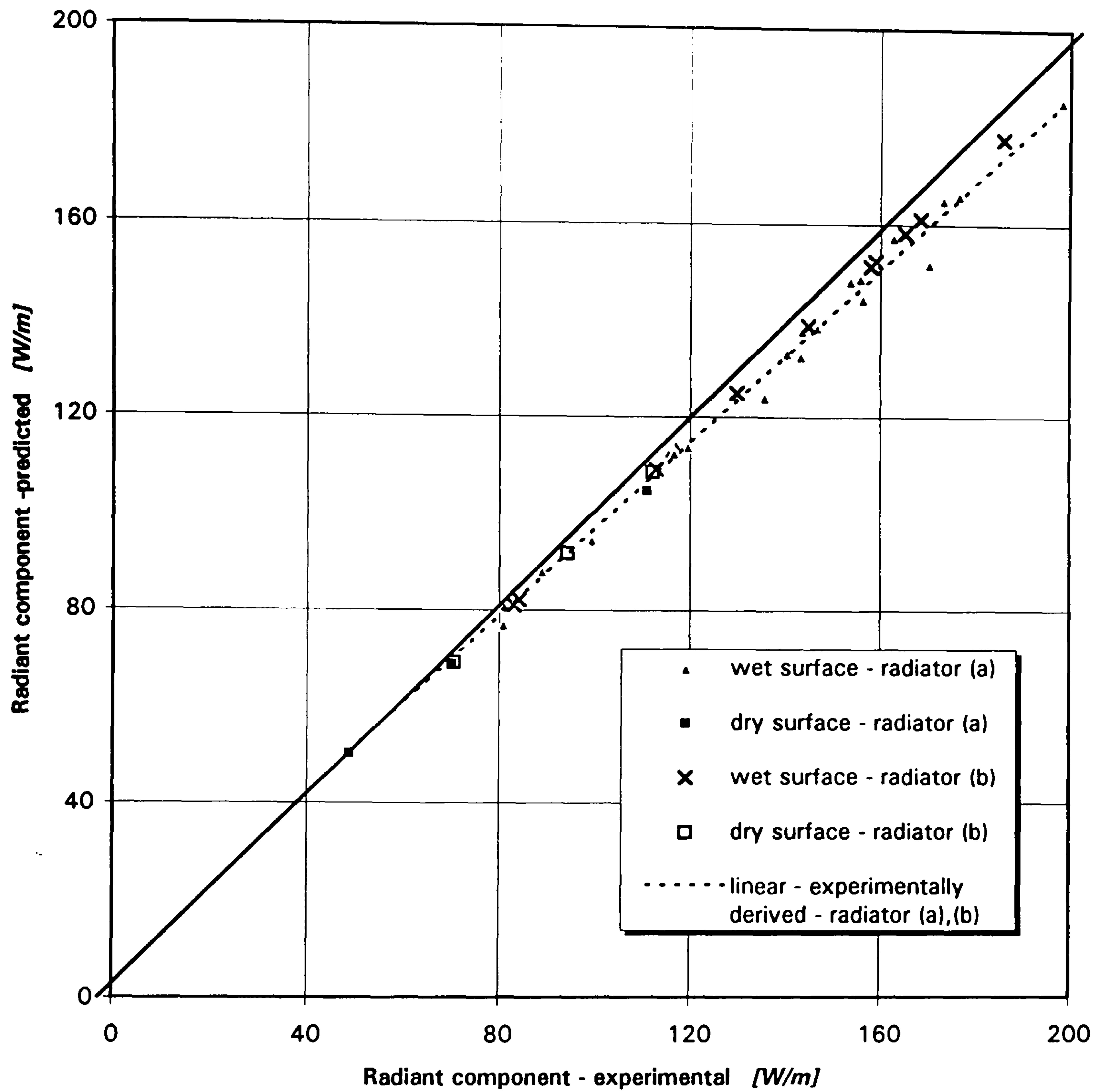

Figure 5.12 Comparison between the theoretical and experimental values of radiant heat transfer of the radiator

assumed that this position of the 'fictitious' surface, used in the two-surface approximation, is appropriate for describing the radiant effect of the radiator heat exchange in the test chamber.

Mean Radiant Temperature Analysis

The globe and air temperatures up to a distance of 1.8 m from the radiator were measured in order to better understand the effects of thermal radiation and how they vary with distance from the radiator (see Figure 4.2). The mean radiant temperatures were calculated using measured values from 45 mm. diffuse black painted globes, taking the local air velocity and air temperatures into account. For a representation of a standing person the average of the mean radiant temperatures at height 0.1, 1.1 and 1.6 m above floor were used [BS 27726, 1993].

The thermal stability and uniformity of conditions in the test chamber are shown in Figures 5.13a. and b., with constant thermal load without the chilled radiator. The mean radiant temperatures along one side of the test room tended to be slightly lower than all other surfaces due to the cold unheated corridor adjacent to this surface.

Figures 5.14a. and b. show the air and mean radiant temperatures within the test room, under steady-state conditions, when the mean radiator surface temperature for both types of radiator were maintained at 10°C. Radiator (a) was placed along the wall at a height of 1.1 m from the floor. Figures 5.14c. and d. show the vertical cross section in the test room along the centre of the radiator for air and mean radiant temperatures. Similarly, Figures 5.15 a. to d. indicate the temperature distribution for radiator (b), which was placed at a height of 0.1 m from the floor.

The measured data in the test room indicate the radiant effect of the radiator, where the mean radiant temperatures are shown to be between 0.5 to 1.2 K lower than the air temperatures in the test room, except in the immediate vicinity of the radiator. Around

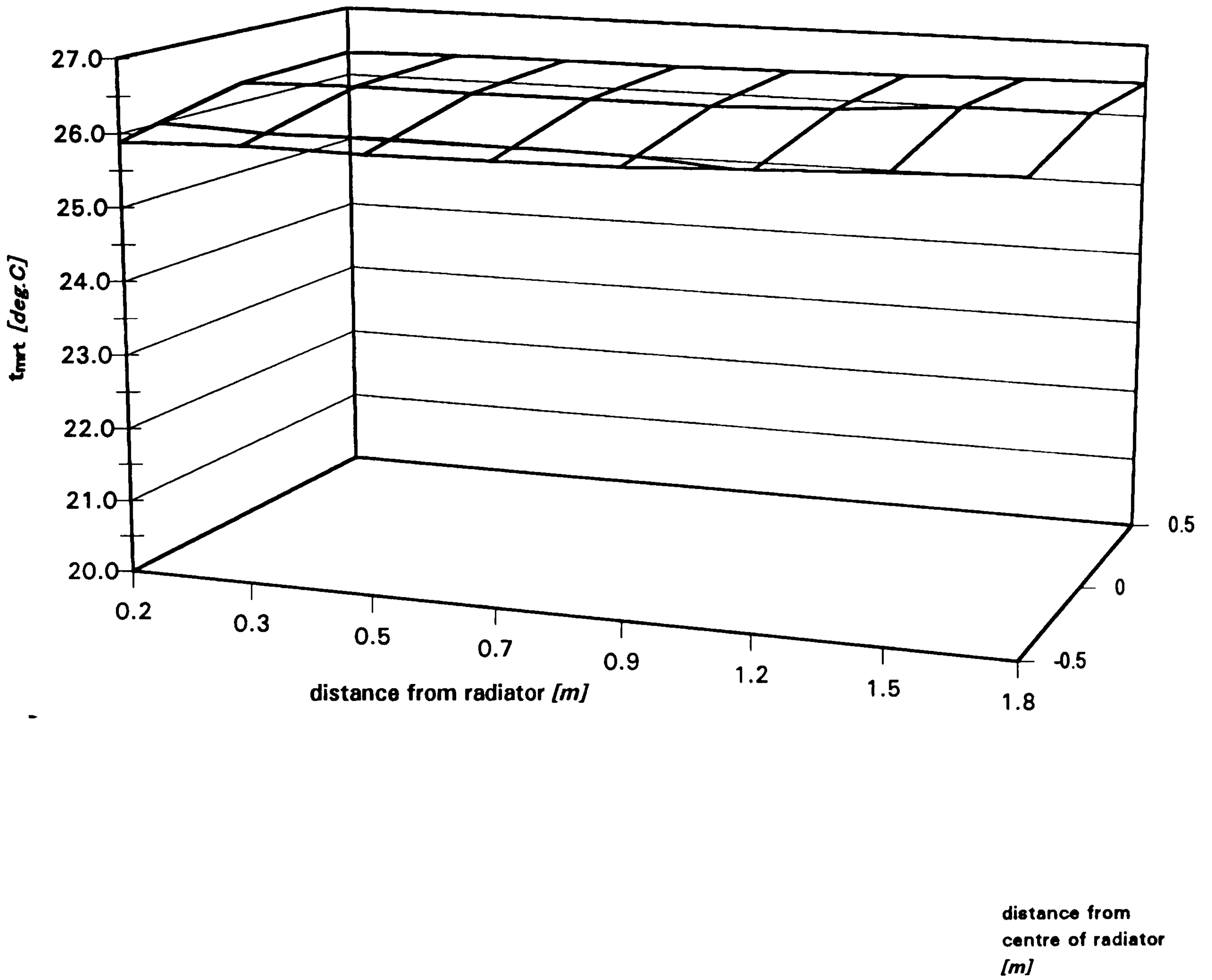

Figure 5.13a Mean radiant temperature distribution (average of measurements at 0.1, 1.1 and 1.6 m above the floor) in the test room without radiator

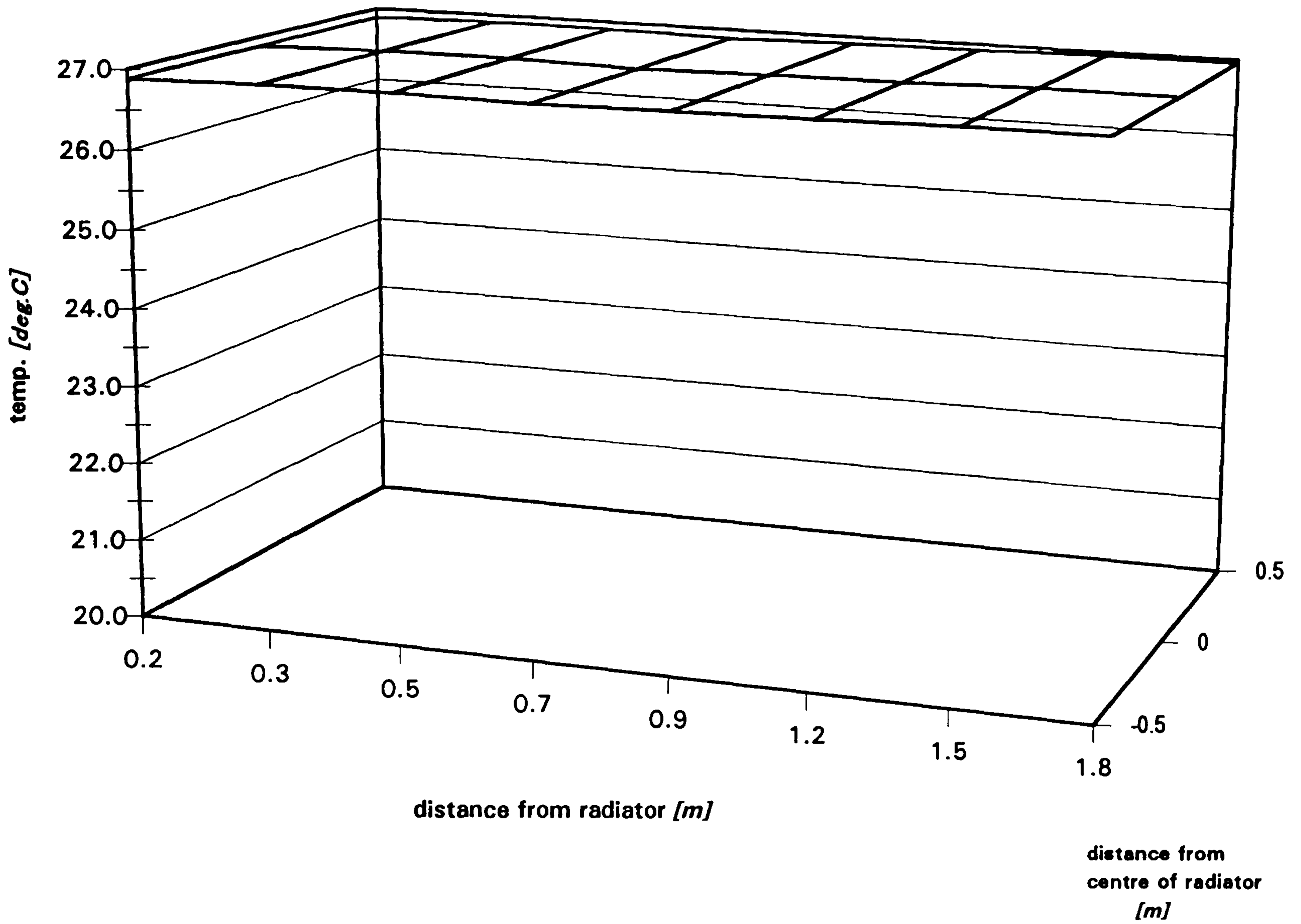

Figure 5.13b *Air temperature distribution at 1.2 m above the floor in the test room without radiator*

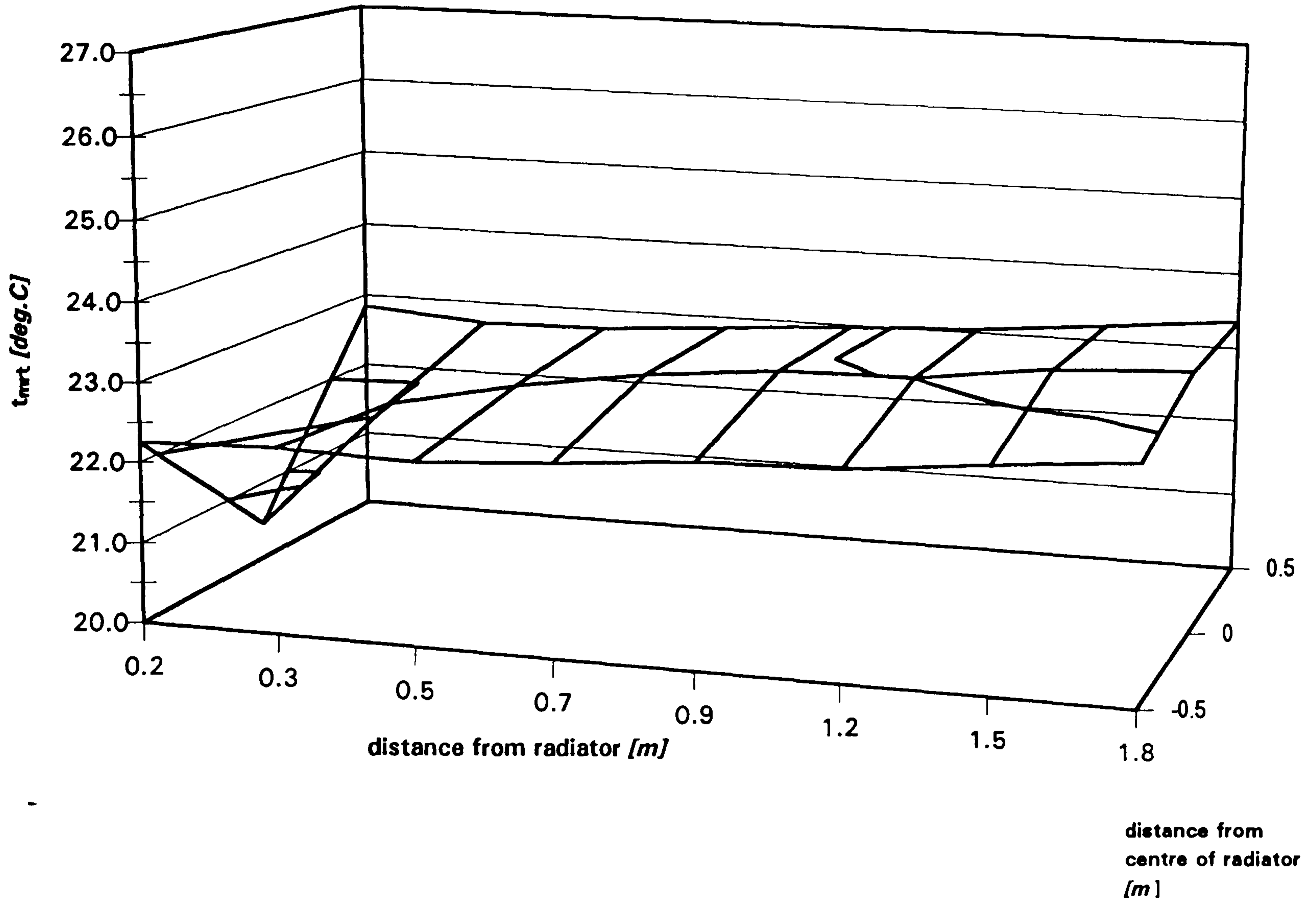

Figure 5.14a

Mean radiant temperature profile (average of measurements taken at 0.1, 1.1 and 1.6 m above the floor) in the test room, with $t_{m,R}=10$ deg C, for radiator (a)

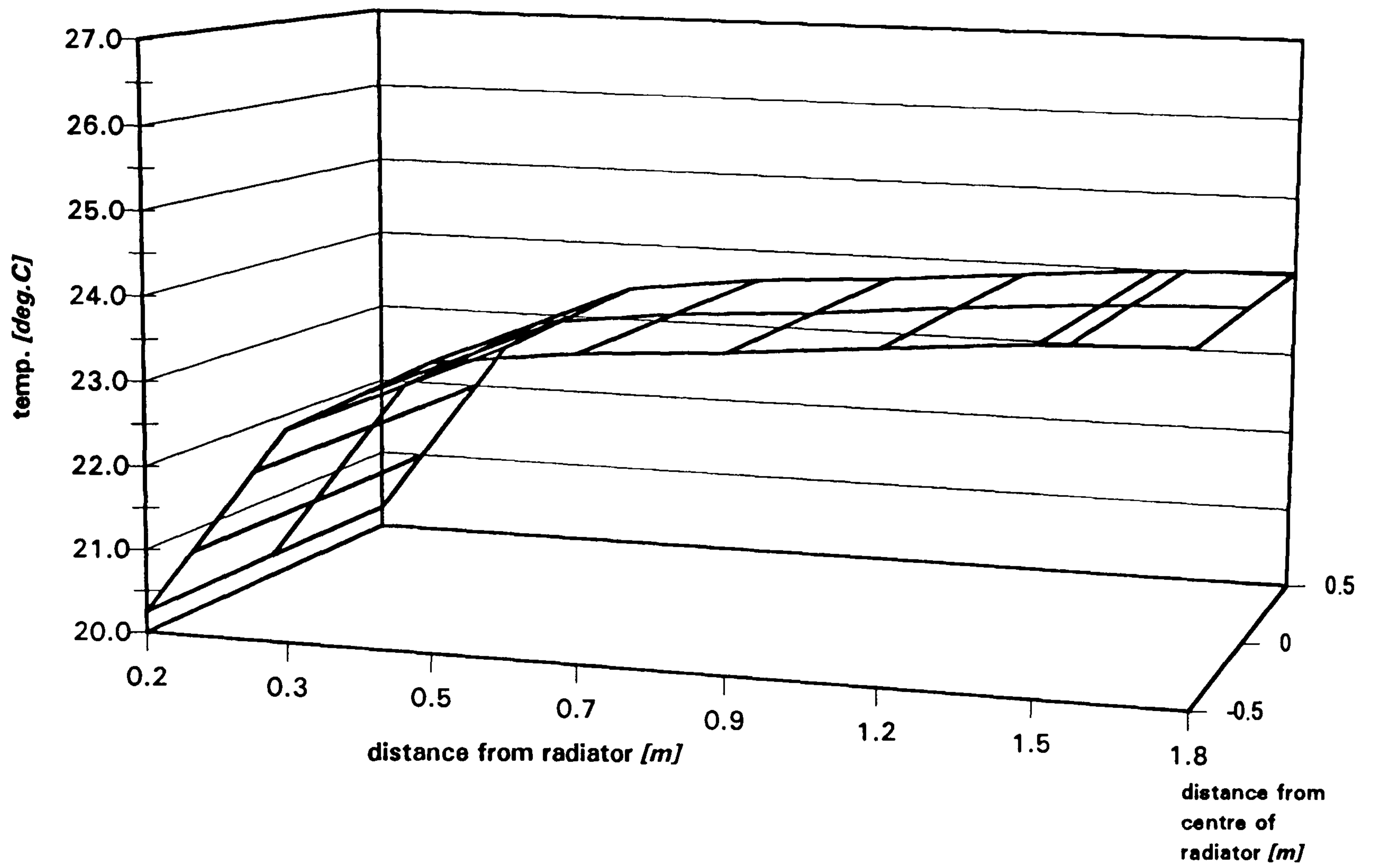

Figure 5.14b

Air temperature profile at a height of 1.2 m above the floor in the test room, with $t_{m,R} = 10$ deg C, for radiator (a)

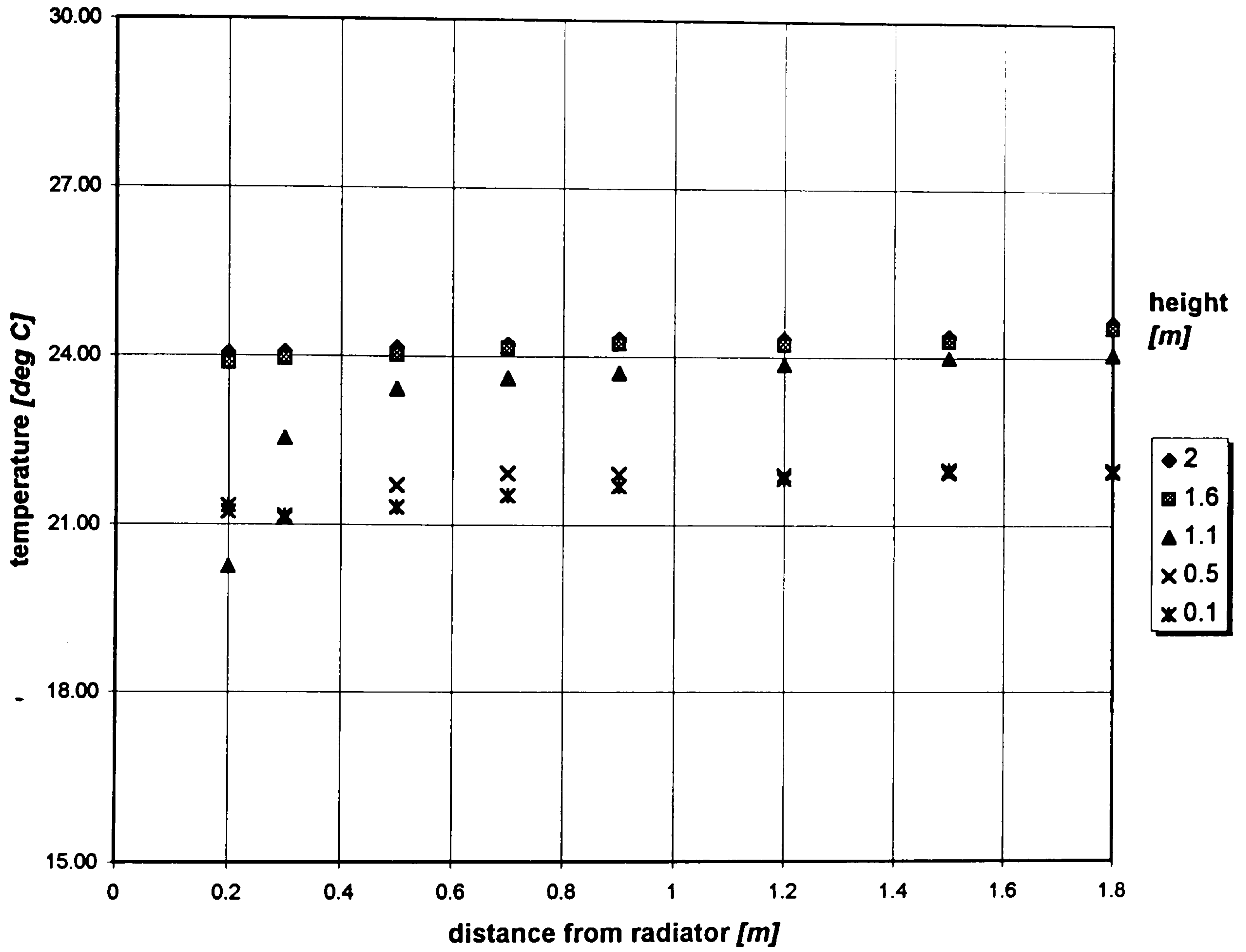

Figure 5.14c *Vertical air temperature profile along the central cross section in the test room, with $t_{m,R} = 10$ degC, for radiator (a)*

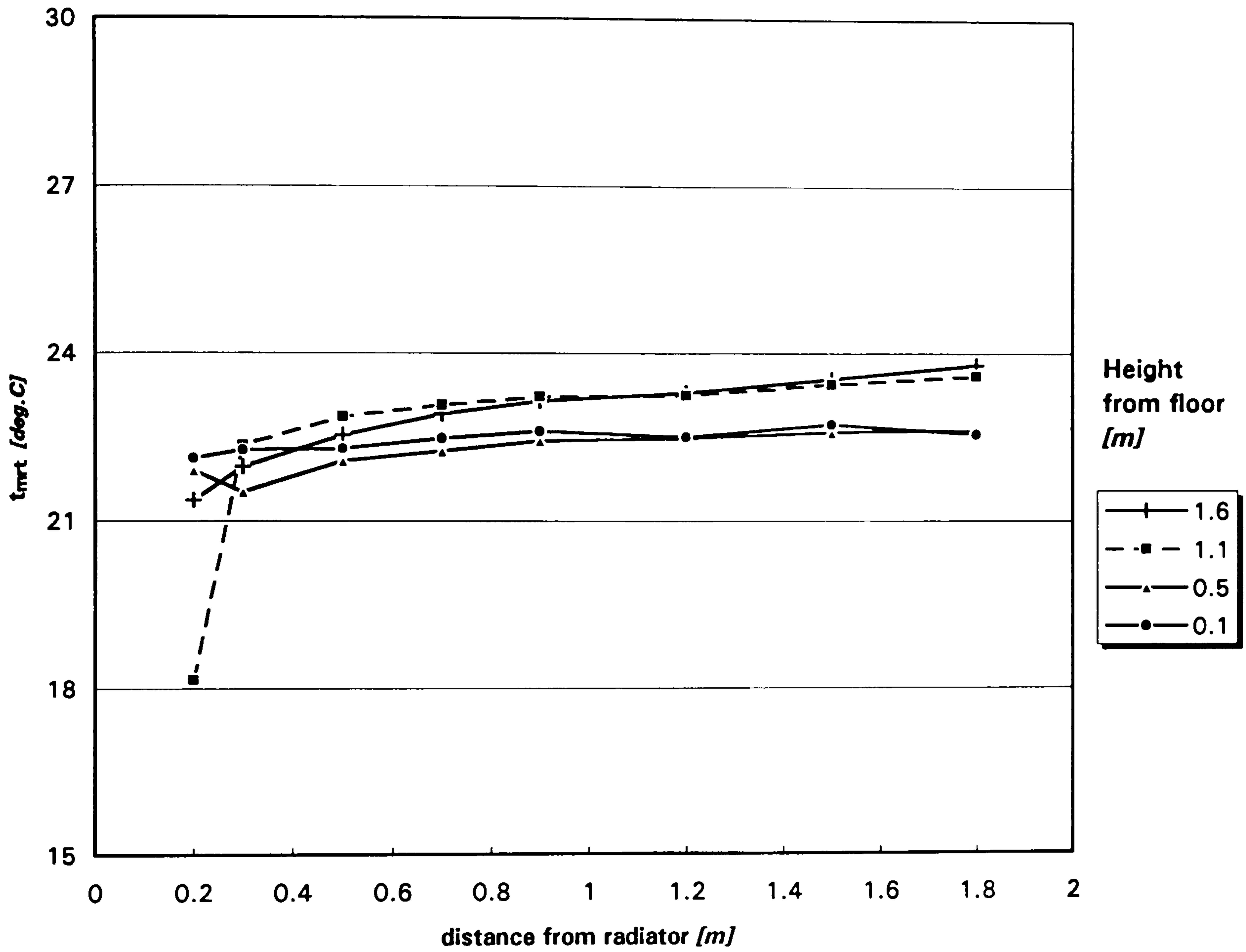

Figure 5.14d *Mean radiant temperature profile along the vertical cross section of the test room, with $t_{m,R} = 10$ deg C, for radiator (a)*

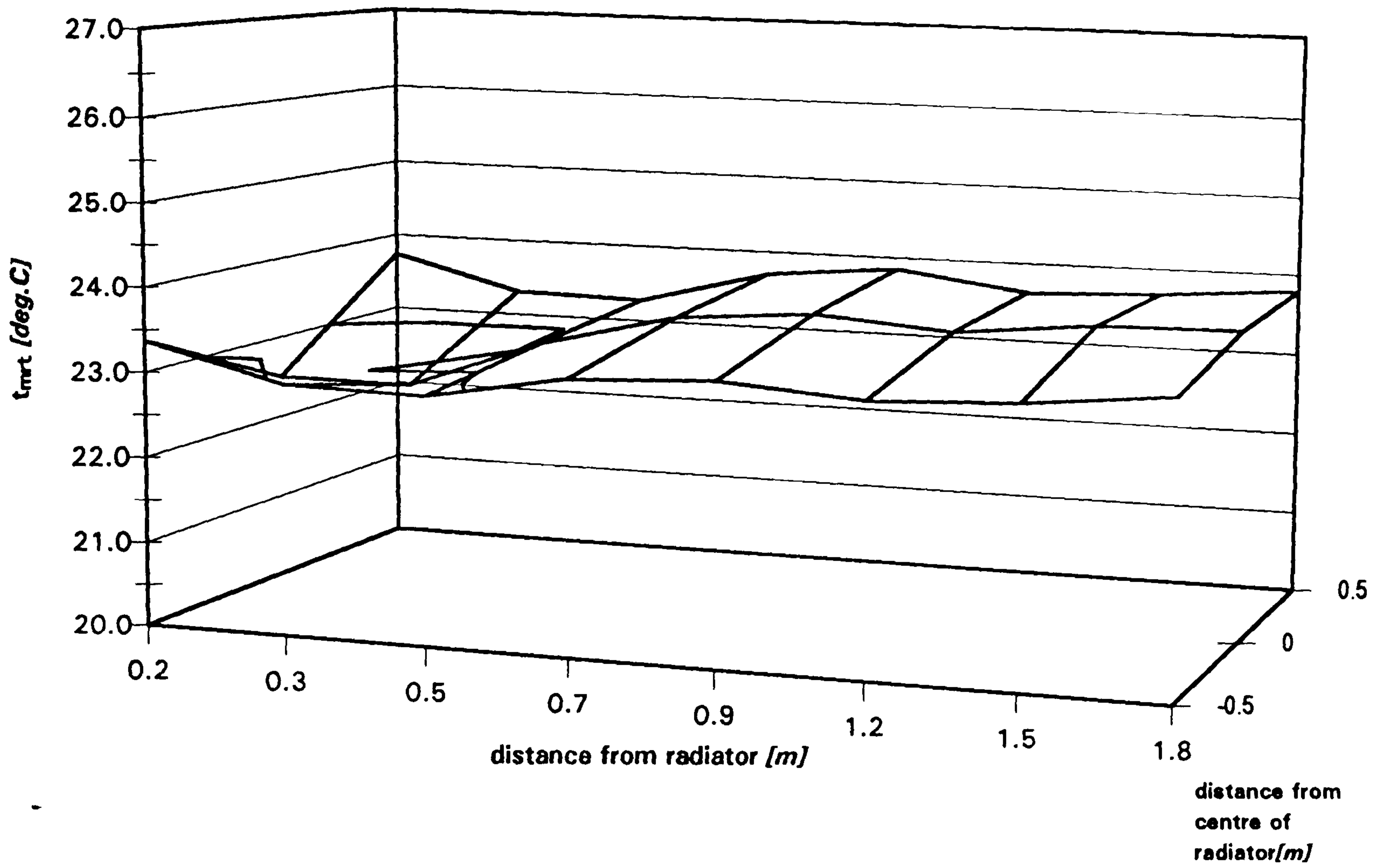

Figure 5.15a

Mean radiant temperature profile (average of measurements at 0.1, 1.2 and 1.6 m above the floor) of the test room, with $t_{m,R} = 10 \text{ deg C}$, for radiator (b)

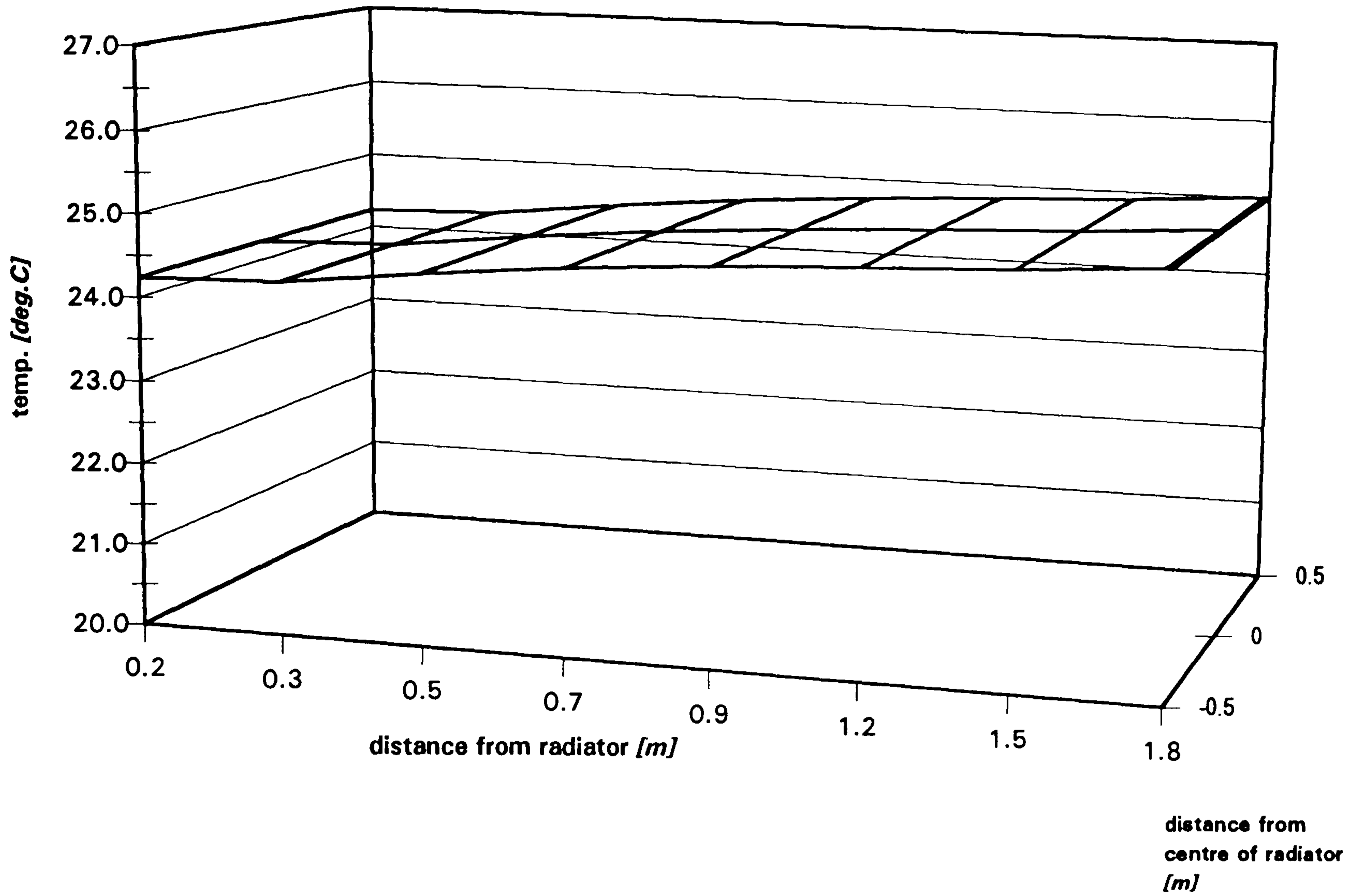

Figure 5.15b

Air temperature profile in the test room at height 1.2 m, with $t_{m,R} = 10$ deg C, for radiator (b)

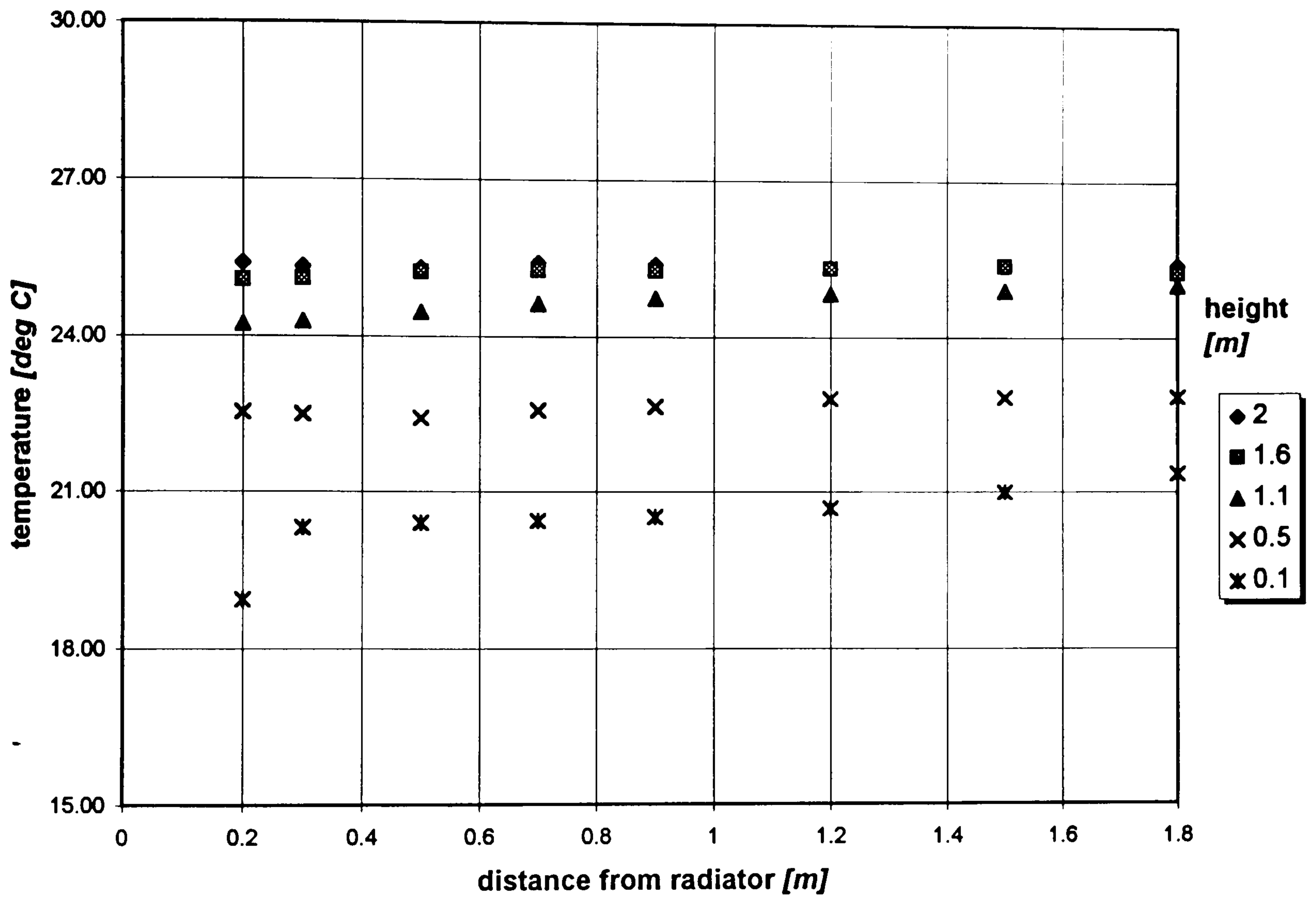

Figure 5.15c

Vertical air temperature profile along the central cross section in the test room, with $t_{m,R} = 10$ deg C, for radiator (b)

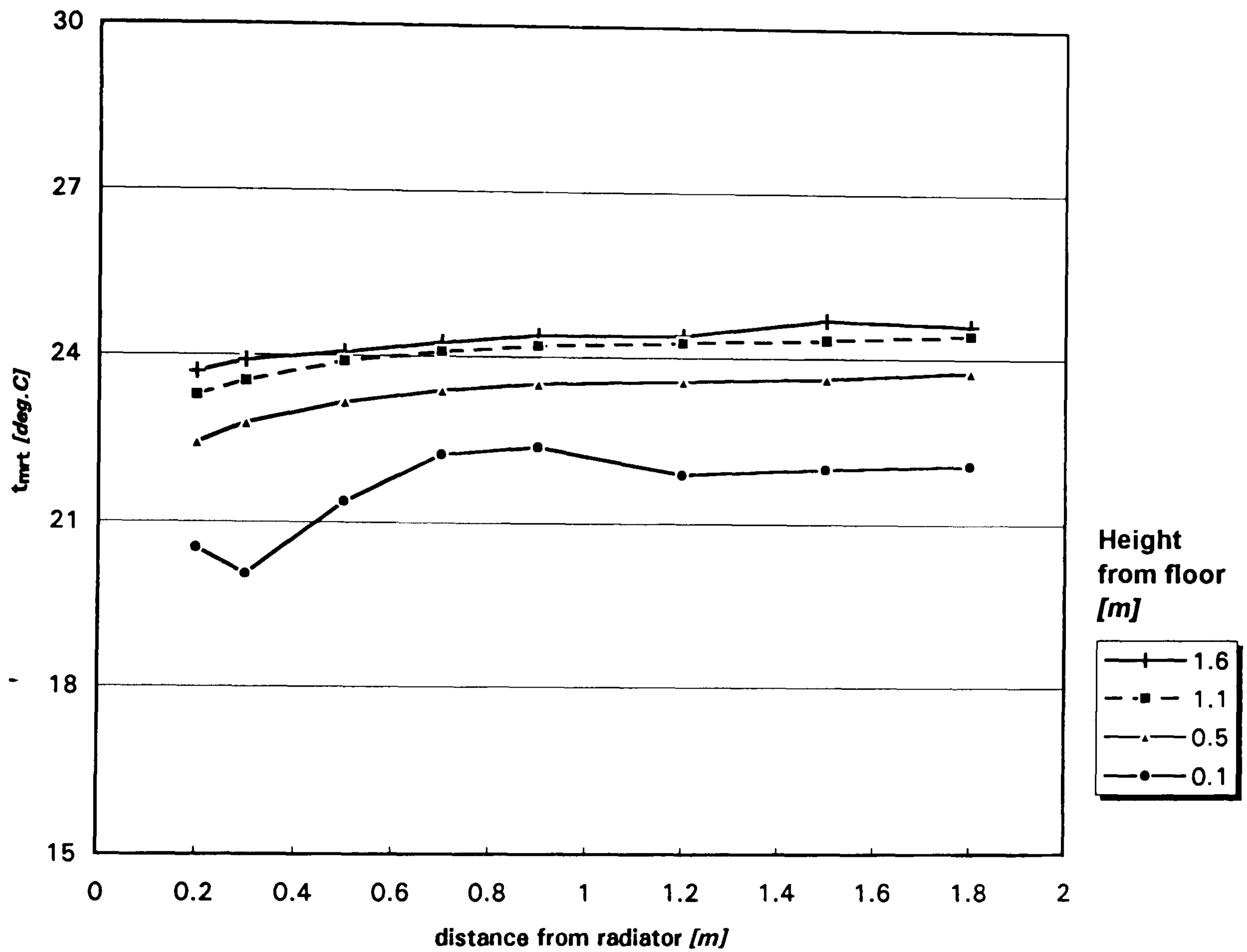

Figure 5.15d

Mean radiant temperature along the vertical cross section of the test room, with $t_{m,R} = 10$ deg C, for radiator (b)

the lower vicinity of the radiator, chilled air currents form downwards along the radiator surface. This creates a slight draught which was measured at a maximum velocity of 0.3 m/s at the base of the radiator. The convective effect of the chilled draught, which would be analogous to the effect of a plume in the heating mode, cools the surfaces near the base of the radiator, resulting in significantly lower temperatures of the air and the surfaces. The vertical temperature differences along the cross section of the test room could be attributed to the chilled air current occurring down the radiator (see Figures 5.14c. and 5.15c.).

Radiator (a), with a length and height of 1 m., placed at a height of 1.1 m off the floor, seems to be more effective in lowering the mean radiant temperatures in the test room than radiator (b), with a length of 0.5 m. and height of 2 m., placed at 0.1 m off the floor. This could be attributed to the radiant effect of the wall surfaces below the bottom of the radiator which were cooled by the convective air current flowing downwards from the radiator. This effectively increased the total surface area in the test room with lowered temperatures. In other words, radiator (a), with higher heat extraction rates than radiator (b) under the same steady-state conditions, would be more effective for lowering the radiant environment if it is placed at a higher position in the test room. The wall area below the radiator would be cooled and so contribute to the reduction of mean radiant temperature. Despite the total radiator surface being approximately equal, the narrower length of radiator (b) did not lower the surrounding temperatures as much as radiator (a).

5.3.3 Heat Transfer by Convection

The theoretical values of the convective heat transfer of the radiator, based on the model for the parallel plate channel described in Sec. 3.3.2, is compared with the values empirically obtained from the experiments. The convective proportion of the heat extraction rate obtained experimentally is defined in terms of the average convective

heat transfer coefficient which is deduced from the latent heat transfer model based on the analogy between heat and mass transfer using the Lewis relation, from the measured amount of condensation on the radiator surface.

The predicted values of the average convective heat transfer coefficient based on the model for the vertical parallel plate channel is plotted against the temperature difference between the ambient air and the mean radiator surface temperatures (see **Figure 5.16**). The predicted average convective heat transfer coefficients for the shorter radiator (a) are higher than those for radiator (b). The experimental results for the two radiators showed that the measured total heat extraction rates of radiator (a) were 10 to 17% higher than those of radiator (b) (see **Figure 5.4**). The tendency of the convective heat transfer model of the two radiators seem to correspond to the differences of the total heat extraction rates measured in the experiments.

Theoretically, the convective heat transfer will be higher for radiator (a) because

- Radiator (a) with double the number of flat tubes than radiator (b) available for convection, would have more air volume passing between the radiator tube channels.
- Longer air channels between the tubes for radiator (b) decrease the temperature difference between the radiator surface and the air, reducing the rate of heat transfer from the air to the radiator surface.

In **Figure 5.17**, the average convective heat transfer coefficient, predicted from the free convection model is compared with the measured values, calculated from the condensation rates on the radiator surface via the Lewis relationship analogy. The predicted heat transfer coefficient for both radiators tend to overestimate the measured values (based on the Lewis relation) at lower heat transfer rates and underestimate the measured values at higher heat transfer rates. The tendency is particularly eminent for radiator (b).

5.3.4 Latent Heat Transfer to the Radiator through Condensation

The latent heat transfer occurring to the radiator due to surface condensation is evaluated by comparing the latent heat transfer rate predicted from the theoretical model based on the analogy between heat and mass transfer using the Lewis relation, and the experimental values calculated from the steady-state condensation rates on the radiator surface. As in the convective model, the predicted values for radiator (b) clearly underestimates the heat transfer rates obtained from the experiments (see **Figure 5.18**). For radiator (a) the results indicate that the model agrees reasonably well with the measured values.

The indication here is that the reliability of the Lewis relationship with the convective heat transfer model diminishes when applied to the taller radiator particularly at higher heat transfer rates.

The steady state condensation rates on the radiator surface are plotted for different dew point temperatures in **Figure 5.19**. The effect of radiator surface temperature on the condensation rate is significant, i.e. the condensation rate increases considerably as the surface temperature of the radiator falls. The condensation rate of the radiator surface is dependent on the difference between the saturated mass ratio of humidity at the condensing surface and the humidity mass ratio of the air. The dominant factor affecting the amount of condensation is the difference between the dew point of the surrounding air and the temperature of the radiator surface.

The condensation rates of radiators (a) and (b) at the same dew point temperature (14°C , 21.2°C) are seen to be identical. This indicates that the difference in height of the radiators between 1 and 2 m. does not affect the condensation rate.

The similar latent heat transfer components of the two radiators imply that the latent heat transfer model using the Lewis relation for heat and mass transfer analogy tend to underestimate the actual values particularly for the taller radiator (b). Furthermore,

since the condensation rates of the two radiators are identical under similar conditions, there may be significant amount of air entrainment along the height of the radiator, which explains the discrepancies between the predicted values of the latent heat transfer rate calculated from the convective heat transfer model.

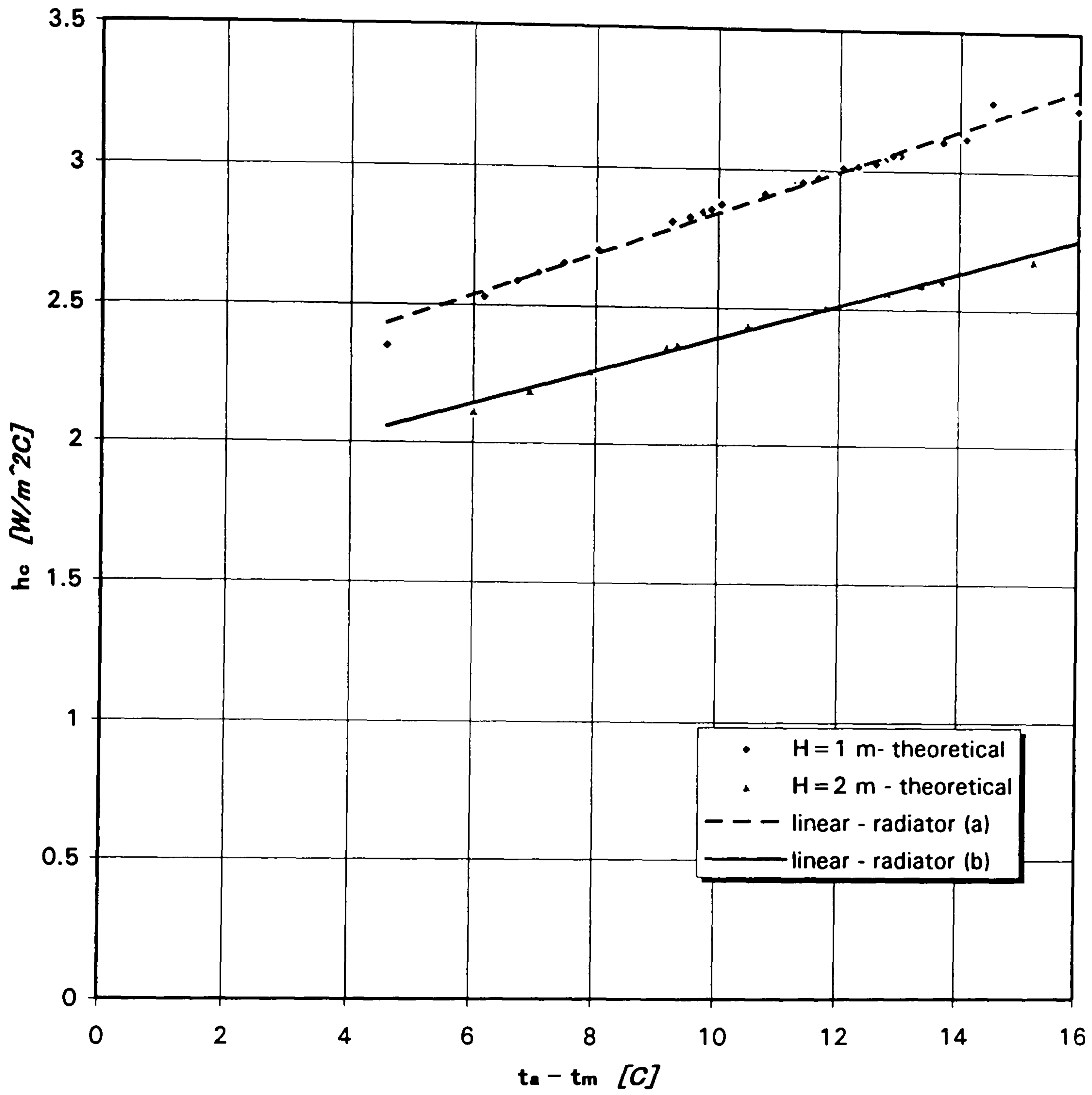

Figure 5.16

Predicted average convective heat transfer coefficient vs mean temperature difference

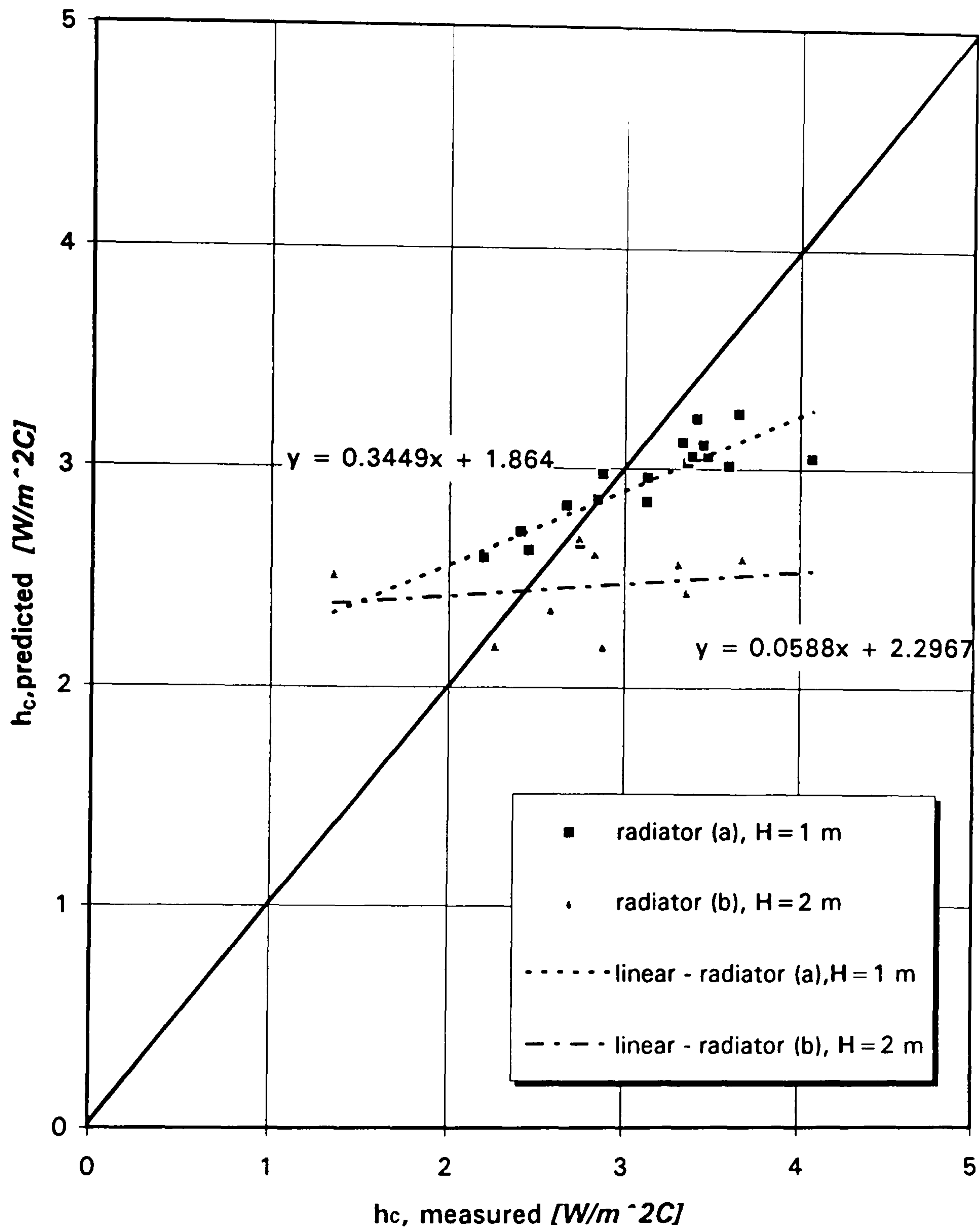

Figure 5.17

Average convective heat transfer coefficient - Predicted vs Measured

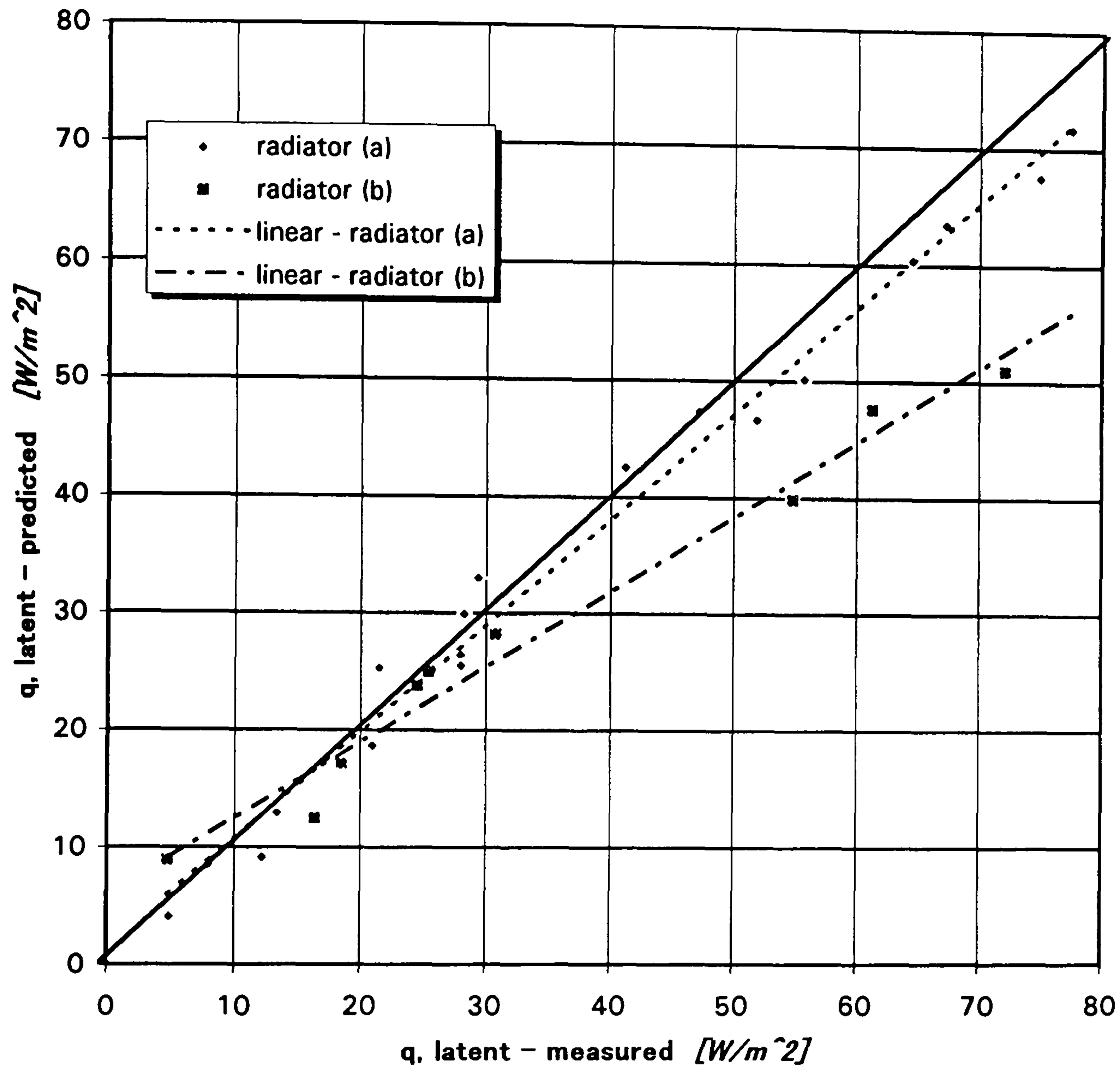

Figure 5.18

Comparison between theoretical and experimental values of the latent heat transfer component

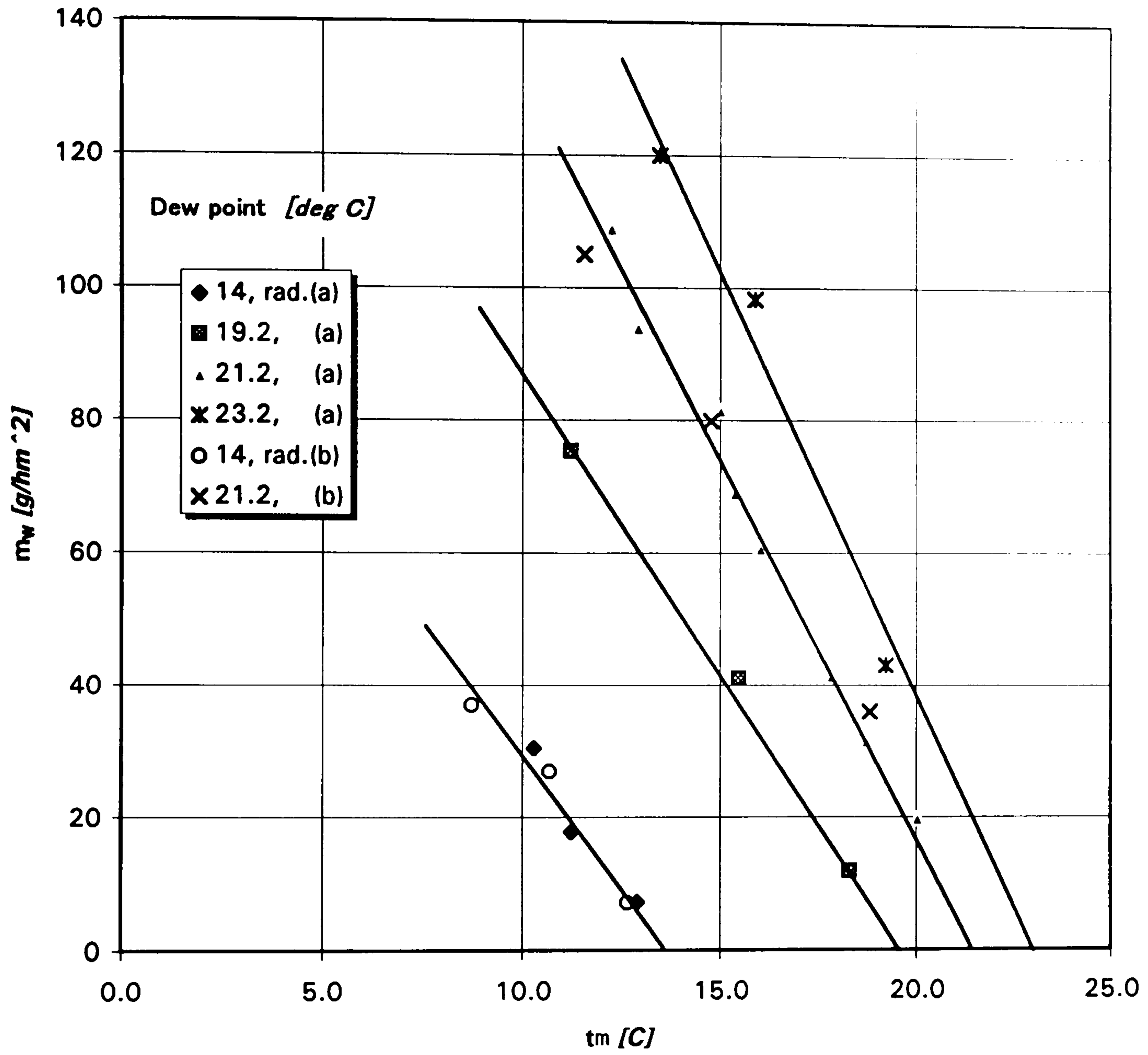

Figure 5.19 Condensation rates on the surfaces of radiator (a) and (b)

5.4 Conclusion

- The heat extraction rates of the two radiators (a) and (b) have been tested. The heat transfer characteristics of the radiator used for cooling and dehumidification by circulating cold water through it involve sensible and latent heat transfer by moisture condensation on the radiator surface. When the radiator surface temperature is below the dew point of the ambient air and condensation droplets are forming on the surface, the overall heat extraction rate increases due to the added component of latent heat transfer.
- The heat extraction rates measured in the experiments have been compared with the sum of individual heat transfer models developed in Chapter 3. The results show a tendency of the predicted values to underestimate the measured values as heat transfer rate increases, particularly with the taller test radiator (b).
- When the surface temperature of the radiator is above the dew point temperature of the room, the radiant proportion of the total heat extraction rate is between 50 and 70%. This is due to the lower temperature differences between the radiator and its surroundings. Theoretically, the radiant component will further increase relative to the convective component if the temperature of the surfaces surrounding the radiator is higher than in the test case, where it was close to the air temperature at steady state conditions.
- The heat transfer characteristics of the radiator used in the cooling and dehumidification mode have been investigated through a comparative study of the individual component models with measured data. The radiant heat extraction rate derived using the modified mean radiant temperature method which was developed to estimate the surface temperatures of the test room without the radiator, has proven to be accurate to within 7% of the theoretical values.

- The discrepancies between the predicted values of the convective heat transfer coefficient and those derived from the measured rates of condensation via the Lewis relation indicate that the convective heat transfer model of isothermal parallel plate channels is difficult to verify using the Lewis relation. It is suggested that the effect of air entrainment along the height of the radiator increased the actual convective effect of radiator (b), compared to the rate of heat transfer described by the convective heat transfer model of the radiator.
- There were no differences between the condensation rates of the two radiators according to the measured rates of condensation on the radiator surfaces at similar conditions. This implies that the convective heat transfer coefficient derived via the Lewis relationship using measured condensation rates will be higher than the values predicted from the convective heat transfer model, since the predicted convective heat transfer coefficients were higher for radiator (a) than for radiator (b).

6 General Discussions

The application of room radiators for the purposes of cooling and dehumidification is a novel idea, which utilises a robust technology developed for winter heating, to deal with the problems of space conditioning in hot and humid climatic regions. The heat transfer mechanism from the radiators is through radiation, natural convection and condensation, and therefore the problems often associated with forced convective systems i.e. air-conditioning systems, such as risks of draughts within occupied spaces are avoided altogether. Furthermore, utilising water as a heat transport medium instead of air has obvious advantages in terms of energy savings.

The implication associated with the use of room radiators for cooling and dehumidification according to the results of this investigation could be summed up as follows.

Heat Extraction Rates of the Radiators

- At a reference ambient temperature of 25°C and 50% relative humidity, the steady state heat extraction rate of radiator (a) with a mean radiator surface temperature of 13°C was measured to be 310 W, of which the proportion of sensible heat transfer was 94% and the proportion of latent heat transfer 6%. When the relative humidity of the ambient air increased to 80%, the total heat extraction rate was 500 W with 55% sensible and 45% latent heat transfer. For radiator (b) at similar conditions, the total heat extraction rate with the mean radiator surface temperature at 12.5°C and relative humidity of 50% was 275 W with 88% sensible heat and 12% latent heat transfer. The total heat extraction rate increased to 450 W with 59% sensible and 41% latent heat transfer when the relative humidity was at 80%.
- The floor space necessary for the installation of radiator (a) in an actual room would be approximately 0.1m² (Length=1 m and Depth=0.1 m including drain-pan for

condensate collection), and that of radiator (b) 0.05 m^2 , indicating the approximate floor space and radiator size necessary to deal with the cooling load in actual buildings.

- In hot and humid climates, the cooling load SHF is in the vicinity of 0.6 (see Section 2.3.3), which is the approximate proportion of sensible heat extraction rate of the radiator measured in the experimental investigation under hot and humid conditions. This indicates a clear advantage in terms of effective load removal since standard air-conditioning systems operate with a SHF of 0.75 to 0.85. Furthermore, because the latent heat transfer rate is dependent on the moisture content of the ambient air, control strategies could be simplified due to the self-adjusting nature of the radiator heat transfer mechanism, as pointed out in Section 2.3.3. In other words, the proportion of sensible and latent heat extraction rates of the radiator will change roughly according to the ambient conditions (cooling load) of the building.

Thermal Comfort

- The importance of the effects of mean radiant temperature on thermal comfort, which has been discussed in Chapter 2, was shown to be a vital characteristic of the radiator in the experimental test chamber. By influencing the mean radiant temperature in the building, comfort requirements could be achieved while enabling higher settings of air temperature. Furthermore, indoor temperature ‘drifts’ which were suggested as potentially advantageous over constant temperatures under the adaptive approach to thermal comfort (see Section 2.2.3), may be more easily realised due to the stable radiant environments created by the proper placement of the radiators.
- Humidity reduction in highly humid climatic regions such as in Japan has important consequences in terms of human perception of comfort as well as for the protection

of building materials. The dehumidification capabilities of the radiator were verified under steady state conditions in the test chamber.

- The risk of local discomfort due to the cold air flow at the base of the radiator was detected. Chilled air at a temperature of 19°C for radiator (a) and 18.7°C for radiator (b) with air velocity of up to 0.3 ms⁻¹ were measured at the distance of 0.2 m from the radiators at a height of 0.1 m. above the floor with the mean radiator surface temperature at 10°C. However, at the distance of 0.5 m from the radiator, the air temperature increased over 1 K and air velocity fell below 0.1 ms⁻¹. Theoretically, there is a risk of local discomfort around the ankles of the occupants in a zone of up to a distance of 0.5 m from the radiators. However, positioning the radiators higher than 0.1 m above floor or as room dividers may prove effective to alleviate such risks of discomfort in the close vicinity of the radiators.
- The possible effects of thermal discomfort caused by radiation asymmetry due to the temperature difference between the radiator and the surrounding walls were considered. Most cases of thermal discomfort due to radiation asymmetry are reported to be from high temperature surfaces above the head of the occupant, or from cold vertical surfaces during the heating season in cold climates [McIntyre, 1980], [Fanger, 1970]. Therefore, the effects of thermal discomfort by radiation asymmetry due to the cold surface of the radiator in hot and humid climates are considered negligible.

Radiator Heat Extraction by Radiation

The process of heat loss by the human body at rest is known to consist of approximately 25% latent and 75% sensible heat, of which radiation and convection are roughly equal (see Chapter 2). The placement of chilled radiators to directly remove the heat produced by the human body, thereby achieving the necessary cooling effect may not be practical in real situations.

The human body, as a heat source in a room, exchanges heat with the surrounding surfaces i.e. walls, the ceiling, floor and any objects within the room. The radiator placed in the room also exchanges heat with the room surfaces, acting as a heat sink. By reducing the temperature of the room surfaces, radiant emission from the human body is enhanced, thereby making radiator cooling effective. This is similar to the effect created by fabric thermal storage in buildings with thermal mass.

A related study on the fundamental benefits of using thermal mass under Japanese (Tohoku region) climatic conditions was performed using the Thermal Analysis Software TAS (see Appendix 1). Chilled radiators were modelled as thin rectangular enclosures using internal walls and setting the temperature of these enclosures so that the external surfaces maintained similar temperatures as chilled radiators in real situations. These simplified models of the radiators were then placed within the building and dynamic simulations were carried out to compare resultant temperatures of the internal space, energy efficiency and operation strategies for low and high mass buildings. This simple study has shown that there are potential benefits of massive buildings in these particular climatic conditions using continuous operation strategy with a reduced plant size.

Strategic Placement of Radiators

One way to maximise the benefits of radiant exchange in rooms using chilled radiators, is to identify the room surfaces with the highest temperatures, usually windows and south facing outer walls, placing radiators to compensate for the high heat source. Possibilities of local discomfort from cold drafts along the base of the radiators and condensation risks to adjacent walls must be carefully addressed for the proper placement of the radiators. Furthermore, careful consideration must be given to the route of the drain pipe for the proper removal of condensate collected at the base of the radiator in order to avoid possible contamination. These are issues that could directly benefit from a close

co-operation between building designers, service engineers and clients during the early stages of the design process.

Growth of Black Mould on Radiator Surfaces

The possibility of mould growth on the wet radiator surface due to condensation is considered minimal due to the following reasons:

- The painted steel surface of the radiator does not absorb moisture.
- The condensation process is continuous, which means condensate droplets that form on the surface are constantly replaced by new droplets which form on the surface cleared by the previous droplets falling to the base of the radiator.

However, possibility of mould growth on the surface of the condensate collection pan at the base of the radiator remains since droplets may not immediately drain off due to the low angle of inclination of the surface. Therefore it would be important for the radiator and its condensate collection pan to be easily accessible for regular cleaning.

In Relation to Passive Buildings

The application of chilled radiators as active measures for the cooling and dehumidification of buildings have distinct similarities to the use of passive measures (see Section 2.3.1.), such as lowering the mean radiant temperatures of the space. The normal operation of conventional air-conditioning systems meant that the buildings had to be sealed, making any use of natural ventilation unfeasible. The use of chilled radiators should enable a more flexible strategy for the operation of the building, including the limited use of natural ventilation due to the high radiant component of the radiator heat extraction rates as shown in this investigation. The potential benefits of the

use of natural ventilation on occupant comfort have been discussed in Chapter 2 (see **Figure 2.6**).

The use of passive features for the reduction of the sensible cooling load of the building in hot and humid climates inevitably raises the **LHF** of the building. The proportion of latent heat removal by the radiator, shown to be as much as 47% of the total heat extraction rate at highly humid conditions, may prove to be an effective supplementary system for passive buildings.

7 Conclusion and Recommendation for Further Work

The heat and mass transfer mechanism of room radiators used in the cooling and dehumidification mode had been studied in order to verify the efficacy of its practical application. Furthermore, a general study on the state of thermal comfort research was undertaken, in order to identify the benefits of operating radiators for cooling and dehumidification.

The theoretical model of the heat transfer mechanism of the radiator with condensation occurring on its surface had been formulated to predict the rate of sensible heat transfer by radiation and convection, and the rate of latent heat transfer by condensation. An experimental rig was set up to test the heat transfer characteristics of the radiator under steady state conditions when chilled water was circulated through it. The individual heat transfer characteristics were derived from experimental data.

The predicted models show good agreement with the experimental results for radiator (a) with a height of 1 m, but not as accurate for radiator (b) with a height of 2 m. The effect of air entrainment along the height of the radiator is attributed to the underestimation of the real values by the convective heat transfer model used for the particular geometric construction of the radiator tested. Through measurements of the globe temperatures in the test room, it was verified that the mean radiant temperature could be directly influenced by the radiator, reducing the temperature 1 K on average below the air temperature in the test chamber.

The heat transfer characteristics of the chilled radiator were shown to be between 30 to 69% of the total heat transfer rate by radiation, 21 to 44% by natural convection and up to 47% by condensation under the test conditions of 25°C and 50% relative humidity to 27°C and 80% relative humidity.

Recommendations for Further Work

Possible topics of research work to follow from this investigation are:

- Optimising the design and construction of the radiators in order to improve heat transfer characteristics
- CFD modelling of internal air movement in buildings with chilled radiators
- Effect of air movement along the radiator on its heat transfer characteristics through flow visualisation
- Design strategies for the optimal use of radiators, both for cooling as well as for heating

A practical study of the chilled radiators in actual operation in buildings will be useful to establish its credibility in the HVAC industry. Some of the areas of general interest would be the following:

- System sizing and operation strategies of chilled radiator cooling and dehumidification system
- Operation strategies under various climatic conditions
- Determination of control strategies of the chilled radiator operation temperatures for buildings with different thermal mass
- Further study on thermal comfort incorporating mean radiant temperature control

Acknowledgements

I would like to thank my supervisor Dr Bill Batty for his tremendous patience, guidance and encouragement throughout the duration, and particularly toward the conclusion of this study.

My grateful appreciation is also due to Mr C Knight of the Applied Energy Department for all his help during the preparation of the experimental rig, Satchwell Controls, for providing the controls for the rig, and Zehnder-Runtal AG of Switzerland for supplying the radiators.

Gratitudes are also due to M Swainson and my colleagues for the bits of support and advice when I most needed them.

Finally, I would like to thank Professor S Aida, my colleagues at PS Company, and my family for making this study possible.

References

Akridge, J. (1982), Investigations of Passive Cooling Techniques for Hot -Humid Climates. Final Report DOE/CS/30238-1, US Department of Energy.

Arnold, D. (1996), Chilled Beams in Naturally Ventilated Buildings, in *Proceedings: CIBSE/ASHRAE Joint National Conference*, pp. 333-338.

Arnold, F. (1980), Dehumidification in Passively Cooled Buildings in *Proceedings 5th National Passive Solar Conference*, Amherst, MA, USA.

ASHRAE, (1992), 'Applied Heat Pump and Heat Recovery Systems', *Systems and Equipment Handbook*, Chap. 8, ASHRAE.

ASHRAE, (1993a), 'Physiological Principles and Thermal Comfort', *Fundamentals Handbook*, Chap. 8, ASHRAE.

ASHRAE, (1993b), 'Residential Cooling and Heating Load Calculations', *Fundamentals Handbook*, Chap. 25, ASHRAE.

ASHRAE, (1995), *HVAC Applications Handbook*, ASHRAE.

Auliciems, A. (1989), in de Dear, R. J. et al. (eds.), (1991), Thermal comfort in the humid tropics - Part II: Climate chamber experiments on thermal acceptability in Singapore, ASHRAE Transactions NY-91-16-3.

Bach, H. (1981), *Niedertemperaturheizung* CFMueller Verlag. (In German)

- **Baillie, A.P., Griffiths, I.D., and Huber, J. W., (1987)**, Thermal Comfort Assessment - A new approach to thermal comfort in buildings, Report to ETSU S-1177, University of Surrey Department of Psychology: Guilford.

Bansal, N. K., Hauser, G., and Minke, G. (1994), *Passive Building Design: A Handbook of Natural Climatic Control*, Elsevier: Amsterdam.

Bar-Cohen and Rohsenow, (1984), in Incropera, F. and Dewitt, D. (1990), *Fundamentals of Heat and Mass Transfer*, Wiley & Sons.

Berglund, L G. (1991), 'Comfort Benefits for Summer Air Conditioning with Ice Storage', *ASHRAE Transactions*, Vol.97 part 1, pp. 843-847.

Bluyssen, P. Fernandes, (1996), New Trends in IAQ and Ventilation in *Proceedings: CIBSE/ASHRAE Joint Conference*, pp. 28-32.

British Standards EN 27726, (1993), *Thermal Environments - Instruments and methods for measuring physical qualities*, BSI.

- Brundrett, G. W. (1987)**, *Handbook of Dehumidification Technology*, Butterworths: London.
- Cena, K. (1994)**, Thermal and Non-thermal Aspects of Comfort Surveys in Homes and Offices in *Conference Proceedings: Thermal Comfort: past, present and future*, BRE Publications.
- Churchill, S. and Usagi, R. (1972)**, 'A General Expression for the Correlation of Rates of Transfer and other Phenomena', *AIChE Journal*, Vol. 18 no. 6, pp 1121-1138.
- CIBSE, (1986)**, *CIBSE Guide Vol. A. Design Data*, The Chartered Institution of Building Services Engineers, London.
- Citakoglu, E. and Rose, J. W. (1968)**, 'Dropwise Condensation - The Effect of Surface Inclination' *International Journal of Heat and Mass Transfer*, Vol. 12, pp 645-651.
- Clark, G. and Blanpied, M. (1982)**, Radiative and Alternative Dehumidification Strategies for Humid Climates, in *Proceedings: International PLEA 1982 Technical Conference*, Pergamon Press, New York.
- Clark, R. P. and Edholm, O. G. (1985)**, *Man and his Thermal Comfort*, E. Arnold: London.
- Collier, J. G. (1972)**, *Connective Boiling and Condensation*, McGraw: London.
- Cook, J. (1989)**, *Passive Cooling*, MIT Press.
- Daniels, K. (1997)**, *The Technology of Ecological Building: Basic Principles, Examples and Ideas*, Birkhaeuser-Verlag für Architektur, Switzerland.
- Davies, M. G. (1987)**, 'Room internal heat exchange: New design method', *Building Services Engineering Research Technology*, Vol. 8, pp 47-60.
- Davies, M. G. (1992)**, 'A review of some methods for calculation internal longwave radiation exchange in buildings', *Building Services Engineering Research Technology*, Vol. 13 no. 2, pp 95-99.
- de Dear, R. J. (1994)**, Outdoor Climatic Influences on Indoor Thermal Comfort Requirements, in *(post-Conference revised version), Proceedings: Thermal Comfort: past present and future*, BRE Publications.
- de Dear, R. J. and Auliciems, A. (1985)**, Validation of the Predicted Mean Vote Model of Thermal Comfort in Six Australian Field Studies, ASHRAE Transactions, pp 452-468.

de Dear, R. J. et al. (1991), Thermal comfort in the humid tropics - Part II: Climate chamber experiments on thermal acceptability in Singapore, ASHRAE Transactions NY-91-16-3.

Elenbaas, W. (1942), 'The Dissipation of Heat by Free Convection from the Inner Surface of Vertical Tubes of Different Shapes of Cross Section', *Physica*, Vol. 9, pp 865-874.

Ellis, E. P. (1953), 'Thermal Comfort in Warm and Humid Atmospheres', *Journal of Hygiene*, Vol. 51, pp 386-403.

EN 442-2. (1997), *Radiatoren und Konvektoren Teil2: Prüfverfahren und Leistungangabe*, European Standards. (In German),

Evans, B. (1995), 'Product Review', *AJ Focus: HVAC*, Sept. pp 43-45.

Fairey, P. et al. (1985), Latent and Sensible Load Distributions in Conventional and Energy Efficient Residences, Final Report FSEC-CR-125-85, Gas Research Institute from Florida Solar Energy Centre.

Fanger, P. O. (1970), *Thermal Comfort*, McGraw-Hill.

Fanger, P. O. (1994), in *Conference Discussions: Thermal Comfort: past, present and future*, BRE Publications.

Frisancho, A. R. (1981), *Human Adaptation*, The University of Michigan Press.

Givoni, B. (1994), *Passive and Low Energy Cooling of Buildings*, Van Nostrand Reinhold.

Gonzalez, R. and Gagge, A. P. (1973), 'Magnitude Estimates of Thermal Discomfort during Transients of Humidity and Operative Temperature and their Relation to the ASHRAE Effective Temperature (ET*)', *ASHRAE Transactions* Vol. 1.

Griffiths, (1983), *Dropwise Condensation: Heat Exchanger Design Handbook*, Vol. 2. Hemisphere Publishing Corp.: New York.

Hannemann, R. J. and Mikic, B. B. (1976), 'An Experimental Investigation into the Effect of Surface Thermal Conductivity on the rate of Heat Transfer in Dropwise Condensation' *International Journal of Heat and Mass Transfer*, Vol. 19. pp 1309-1317.

Hayano, H. et al. (1994), A Development of Radiant Air-Conditioning System, 2nd Report: Evaluation of Thermal Comfort under a Radiant Cooling System by Subjective Experiments. (In Japanese),

Hori et al. (1978), quoted in Tanabe, S. and Kimura, K. (1987), *Thermal Comfort Requirements under Hot and Humid Conditions*, ASHRAE Transactions, Vol. 93, no. 1, pp 564-577.

Horikoshi, T. et al. (1991), Indices of Combined and Independent Effect of Thermal Environmental Variables upon the Human Body, ASHRAE Transactions: 3464.

Humphreys, M. A. (1974), 'Environmental Temperature' and Thermal Comfort, CP 80/74.

Humphreys, M. (1994), Field Studies and Climate Chamber Experiments in Thermal Comfort Research in *Conference Proceedings: Thermal Comfort: past, present and future*, BRE Publications.

Humphreys, M. (1995), 'Thermal Comfort Temperatures and the Habits of Hobbits' in Nicol, F., Humphreys, M. and Sykes, O. (eds.), *Standards for Thermal Comfort, Indoor air temperature standards for the 21st century*, Chapman & Hall: London.

Humphreys, M. and Nicol, F. (1996), Conflicting Criteria for Thermal Sensation within the Fanger Predicted Mean Vote Equation, *CIBSE/ASHRAE Joint National Conference Papers*, pp 153-158.

IEA, (1992), Workshop Report, Future Buildings forum - Innovative Cooling Systems, *IEA - Energy Conservation in Buildings and Community Systems Programme*, 12-14 May 1992.

Khatter, M. (1983), *Moisture control in passive buildings in warm, humid climates*, (source unknown),

Kobayashi, Y. et al. (1995), A survey of comfort conditions and requirements in bedrooms, *SHASE Proceedings*, 10 (In Japanese),

Kurihara, T. et al. (1989), A Study on Panel Air System Part I: Installation and Temperature, Scientific Papers of the Japan Architectural Society, No. 4510 10 (In Japanese).

Kusada, T. (1983), Indoor Humidity Calculations, ASHRAE Transaction: 89(2B),: 728- 40.

Lefevre, E. J. and Rose, J. W. (1965), 'An Experimental Study of Heat Transfer by Dropwise Condensation', *International Journal of Heat Transfer*, Vol. 8, pp 1117-1133.

McIntyre, D.A. (1980), *Indoor Climate*, Applied Science Publishers Ltd.: London

Nicol, F. (1993), *Thermal Comfort - A Handbook for Field Studies Toward an Adaptive Model*, University of East London: London.

Olgvay, V. (1962), *Design with Climate, Bioclimatic Approach to Architectural Regionalism*, Van Nostrand Reinhold: New York.

Oseland, N. (1993), in Raw, G. J. and Oseland N. A. (1994),, Why another thermal comfort conference? *Conference Proceedings; Thermal Comfort: past, present and future*, BRE Publications.

Parsons, K. C. (1993), *Human Thermal Environments*, Taylor & Francis Ltd.: London.

Raw, G. J. and Oseland, N. A. (1994), Why another thermal comfort conference? *Conference Proceedings; Thermal Comfort: past, present and future*, BRE Publications.

Rose, J. W. (1981), 'Dropwise Condensation Theory', *International Journal of Heat and Mass Transfer*, Vol. 24, pp 191-194.

Scheatzle, D. (1992), Use of Thermal Comfort Model to Control Low Energy Systems, Workshop Report, FBF - Innovative Cooling Systems, IEA - Energy Conservation in Buildings and Community Systems Programme, Oscar Faber Applied Research Ltd.

Schiller, G. (1990), in Raw, G. J. and Oseland N. A. (1994), Why another thermal comfort conference? *Conference Proceedings; Thermal Comfort: past, present and future*, BRE Publications.

Senuma, H. et al (1995), Development of Panel Heating & Cooling System, Part 5: Evaluation of Panel Cooling System using Improved Dehumidifier in *SHASE Proceedings*, 10.95 (in Japanese),

Shirey, D. B. (1993), Demonstration of Efficient Humidity control Techniques at an Art Museum, ASHRAE Transactions: Research 3688 (CH-93-18-4),

Stefanizzi, et al. (1990), 'Algorithms: Internal long-wave radiation exchange in buildings: Comparison of calculation methods: II Testing of algorithms', *Building Services Engineering Research Technology*, Vol. 11, no. 3, pp 87-96.

Stokols, D. (1991), quoted in Raw and Oseland, (1994), Why another thermal comfort conference? *Conference Proceedings; Thermal Comfort: past, present and future*, BRE Publications.

Tanabe, S. and Kimura, K. (1987), *Thermal Comfort Requirements under Hot and Humid Conditions*, ASHRAE Transactions, Vol. 93, no. 1, pp 564-577.

Todd, T. R. and Pate, M. E. (1987), *Passive Humidity Control: A Comparison of Air-Conditioning Capacity Control Methods for the Humid Climate*, (source unknown).

Vadon, M. (1992), Advances in Classical Systems, workshop Report, FBF - Innovative Cooling Systems, IEA - Energy Conservation in Buildings and Community Systems Programme, Oscar Faber Applied Research Ltd.

Wada, T. et al. (1994), A study on the differences of the thermal votes in case of radiative and convective cooling in short periods, Scientific Papers of the Japan Architectural Society, No. 41729. (in Japanese),

Walton, G. N. (1980), A New Algorithm for Radiant Interchange in Room Loads Calculation, ASHRAE Transactions: 86 2 190-208.

Weber, J. (1993), 'Problemfeld Sick-Building Syndrom - Eine Herausforderung an die interdisziplinäre Zusammenarbeit in der Gebäudetechnik' *HLH*, 44, p 9. (In German),

Williamson, T. J. et al, (1995), 'Comfort, Preferences, or Design Data?', in Nicol, F., Humphreys, M. and Sykes, O. (eds.), *Standards for Thermal Comfort, Indoor air temperature standards for the 21st century*, Chapman & Hall: London.

Yoshino, H. et al. (1994), Indoor Environment and Energy Consumption in Well-insulated and Airtight Houses in Tohoku District in *Proceedings: 18th Symposium on Human-Environment System, Society of Human-Environment System*. (In Japanese).

Yoshino, H., Ishikawa, Y., Nagatomo, M. and Sasaki, K., (1996), 'Measurement on the Amount of Thermal Radiation of Hot Water', *AIJ Journal*, no. 2, pp. 140-143.

Bibliography

Al-Hinai,(1992), *Natural Cooling Techniques for Buildings in Hot Climates* PhD Thesis, Cranfield Institute of Technology. (Unpublished).

Appleby, (1992), 'Building Services', *The CIBSE Journal* June p.36.

ASHRAE, (1985), 'Physiological Principles for comfort and health' *Fundamental Handbook* Chap.8 ASHRAE

Bartholomew, D. M. L., Parand, F., and Bloomfield, D. P. (1993), The Treatment of Occupancy in the Thermal Modelling of Dwelling, *CIBSE National Conference 1993*.

Behne, M. (1993), 'Einfluss der Kuehlfleckenanordnung auf die thermische Behaglichkeit' *HLH 44*, Nr.7-July. (In German)

Berglund, L. G. and Gonzalez, R. (1978), 'Application of acceptable temperature drifts to built environment as a mode of enrgy conservation'. *ASHRAE Transaction* Vol. 84, part 1.

Brothers, P. and Cooney, K. (1989), 'A knowledge-based system for comfort diagnostics', *ASHRAE Journal*, September.

BSI8207, (1985), *British Standard Code of practice for Energy efficiency in buildings*,
British Standard Institution.

- **Citakoglu, E. (1966),** *Heat Transfer by Dropwise Condensation*, PhD Thesis- London University. (Unpublished),

Cohen, R. R., Munro D. K. and Ruyssevelt, P. A. (1993), 'Overheating Criteria for Non-Air-Conditioned Buildings', *CIBSE National Conference*.

CIBSE, (1986), *CIBSE Guide Vol.A Design Data*, The Chartered Institution of Building Services Engineers:London.

DIN 4704, (1988), *Pruefung von Raumheizkoerpern*, DIN Deutsches Institut fuer Normung. (In German)

Ernest, D. R., Baumann, F. S. and Arens, E. A. (1991), 'The Prediction of Indoor Air Motion for Occupant Cooling in Naturally Ventilated Buildings', *ASHRAE Transactions*, Vol.97 no. 1.

Fanger, P. O., Thorstensen, E. et al. (1990), 'Air Pollution Sources and Indoor Air Quality in Schools', *Proceedings of Indoor Air '90* , July 1990.

- Gagge, A. P. and Nishi, Y. (1976)**, 'Physical Indices of the Thermal Environment', *ASHRAE Journal*, Jan.
- Glueck, B. (1992)**, 'Kuehldecken/Leistung - Raumseitige Waermestromdichte Geschlossenen Kuehldecken', *HLH 43*, Nr.12-December. (In German)
- Glueck, B. (1992)**, 'Raulufttechnik / Waermeuebergang - Waermetechnische Kopplung von Masiv- und Kuehldecke', *HLH 43*, Nr. 7-July. (In German)
- Hirayama, Y. and Batty, W. J. (1995)**, 'An Investigation of Wet Cooling Systems Utilising Room Radiators', *Proceedings of the CIBSE National Conference*, 1-3 October, Eastbourne, Vol. 1. pp246-253.
- Incropera, F. and DeWitt, D. (1990)**, *Fundamentals of Heat and Mass Transfer*, Wiley & Sons.
- Inouye, U. (1982)**, *Airconditioning Handbook (KuukiChowa Handbook)*, Maruzen. (In Japanese),
- Kast, W. (1993)**, 'Simulation der Temperatur- und Geschwindigkeitsfelder in deckengekuehlten Raeumen' *HLH 44*, Nr.7-July. (In German)
- Kimura, K. (1977)**, *Scientific Basis of Air Conditioning*, Applied Science Publishers.
- Kohler et al, (1986)**, *Haustechnik in der Integralen Planung, Band A and B*, Bundesamt fuer Konjunkturfragen: Bern. (In German)
- Kotake, S. (1978)**, *Survey of flows with Nucleation and Condensation*, University of Toronto.
- Kruehne, H. (1993)**, 'Einfluss konvektiver Wandstroemungen auf die Luftqualitaet bei Quellueftung', *HLH 44*, Nr.7-July. (In German)
- Leaman, A. (1993)**, 'Window Design for Natural Ventilation', *Notes for BRE Seminar*, 17 May .
- Markus, T. A. and Morris, E. N. (1980)**, *Buildings, Climate and Energy*, Pitman Publishing: London.
- Recknagel, Sprenger, and Hoenmann, (1989)**, *Taschenbuch fuer Heizung & Klimatechnik 88/89*, Oldenbourg Verlag. (In German)
- Simmonds, P. and Van Heugten, R. T. B. (1993)**, 'Experience with Naturally Ventilated Atria', *CIBSE National Conference*.
- Simmonds, P. and Van Heugten, R. T. B. (1993)**, 'Dynamic Comfort Control', *CIBSE National Conference*.

Soller, B. (1983), 'Strahlplattenheizung-Waermeabgabe von Strahlplatten', *Heizung Klima Heft* v.4, no. 5, p6. (In German)

Thiel, D. (1992), 'Raumluftechnik / Simulation RLT-Anlagenkonzept mit natuerlicher nachtkuehlung', *HLH 43*, Nr.7-July. (In German)

VDI 2078, (1990), *Berechnung der Kuehllast klimatisierter Raeume (VDI Kuehllastregeln)*, Verein Deutscher Ingenieure. (In German)

Wilkins, D. G. and Bromley, L. A. (1973), 'Dropwise Condensation Phenomena', *JAICHE*, Vol 19, pp839-845.

Yannas and Fernandes, (1988), 'Energy and Buildings for Temperate Climates', *Proceedings of the 6th Int'l PLEA Conference Portugal*, 27 - 31 July 1988.

Yoshino, (1993), Illustrated Investigation Results on Indoor Climate of IDIC-PS Onishimizu Factory, Department of Architecture, Tohoku University. (In Japanese)

Zimmer, J. (1992), 'Heizflaechen / Auslegung - Betriebsoptimierung von Raumheizkoerper in Beharrungszustaenden', *HLH 43*, NR.8-August. (In German)

**Proceedings, MEGASTOCK '97, 7th International Conference on Thermal Energy Storage, 18-21 June 1997, Sapporo Japan*

**INVESTIGATION OF THERMAL ENERGY STORAGE WITHIN BUILDING
THERMAL MASS IN NORTHERN JAPAN THROUGH DYNAMIC BUILDING
AND BUILDING SERVICES SIMULATION**

Y. Hirayama*, S. Jolly** and Dr. W J Batty
Department of Applied Energy, Cranfield University
Cranfield, Bedford MK43 0AL England
Fax:+44-1234 750728
*PS Company Ltd., Japan
**Ove Arup & Partners, UK.

ABSTRACT

The application of building mass for thermal storage for cooling and heating within the context of the climatic conditions found in the Tohoku Region of Japan has been investigated. Fully dynamic building and building systems thermal analysis computer software, using local climate data, has been used to compare and analyse the thermal performance of a building with different thermal capacities. This has been achieved by adjusting the structural components in the computer model of the building which was originally of light-weight construction. The results show that the use of massive construction attenuates variations in the internal load, contributing to a more stable internal environment providing thermally comfortable conditions during all seasons of the climate in the Tohoku Region of Japan. The stable internal thermal environment with massive construction provides a good platform for reducing plant size for heating and cooling resulting in less primary energy consumed, but only if the operation strategies are properly defined.

1. INTRODUCTION

Traditional Japanese architecture developed to provide as much ventilation and air movement through a building as possible during the hot and humid summer months. Consequently, a tradition of lightweight structures developed, and the use of thermal mass to ameliorate the effects of the diurnal or seasonal climate has not been considered as relevant to Japanese buildings.

In their study, Kimura and Tanabe¹ compared a massive structure with a lightweight reinforced concrete structure in Kawagoe, near Tokyo during the summer season, both without any mechanical cooling. They found more comfortable conditions of relative humidity and resultant or operative temperatures in the massive structure, but deliberate use of building mass for thermal storage in such structures remains uncommon.

The climate experienced in Japan is not uniform with regard to location. The more northerly latitudes experience shorter hot and humid summers and suffer longer severe winters due to the cold Siberian high pressure area than those in the south and western regions. Building forms that are more suitable to the climates of Tokyo, for example do not necessarily provide good conditions for winter comfort in northern regions such as Hokkaido and Tohoku, the northern regions of Japan.

The use of building mass for thermal storage in the northern regions in Japan should have the same potential benefits as those experienced in the temperate climates of Europe. Some of these benefits include:

- the use of cheap rate, night time electricity to offset the cost of daytime heating or cooling,
- the reduction of plant output rates required to satisfy heating and cooling loads,
- the use of "free cooling" provided by cool night-time ambient air temperatures resulting from diurnal temperature swings and so removing the need for air conditioning, and
- improved thermal comfort conditions due to a more stable radiant temperature environment

The effectiveness of a building element in storing thermal energy depends upon its:

- heat storage capacity and where it occurs within a structural building element;
- building orientation for the location
- the extent of thermal insulation and its position in building
- ventilation rate
- climatic conditions and
- use of mechanical heating or cooling systems

The heat storage capacity of thermally massive materials on the inner surface of walls, floors or ceilings can cause a delay in room temperature changes to corresponding external temperature changes and attenuate the internal temperature fluctuation.

All building elements such as walls, roof and floor can be used for thermal storage. There are techniques to increase the efficiency of storing heat by creating flow of fluids, such as air or water, through or over massive components of the building's structure. Additional storage can be provided by placing additional masonry stone, water or pebble stones in the wall or roof. For the purpose of simple comparison and applicability to conventional buildings, this investigation is carried out by modelling an existing building and analysing its thermal performance whilst varying the thermal storage capacity of the wall construction.

2. BUILDING AND CLIMATE MODEL

The Tas°, Thermal Analysis Software, used for this study comprises several component programs which combine together to provide a dynamic simulation of the heat transfer processes taking place in the building under test.

The building chosen as the basis for this study is an actual building located in Iwate Prefecture in the Tohoku Region. Climate data from recorded and estimated climate data sources for the city of Morioka was used for the estimation of the external load pattern applied to the model in the thermal simulations.

Two types of buildings were modelled for comparison. Timber construction, which corresponds to the actual plan of the building, was used to model the lightweight type and reinforced concrete was chosen for the massive construction. Otherwise the buildings are identical in plan and orientation. The plan dimensions are 27.3m by 7.28m and the height is 8.7m at the pitch of the roof. The U-values for both wall types were set to be identical at $0.18 \text{ Wm}^{-2}\text{K}^{-1}$ by adjusting the material thickness of insulation for the massive building. The different values for the thermal mass of the building element are expressed as $\text{kJm}^{-2}\text{K}^{-1}$ and comparisons for the massive and lightweight construction are shown below:

	<u>Massive</u>	<u>Light Construction</u>	
External Walls	185	10.4	
Internal Walls	92	10.4	[$\text{kJm}^{-2}\text{K}^{-1}$]
Ground Floor	285	25	

The position of the high mass component of the wall in the massive building is immediately adjacent to the internal space with external insulation. The east side of the building will receive significant solar radiation in the morning. The west side of the building is mostly shaded by dense vegetation in the actual building and therefore receive very little afternoon sun. Shading has been incorporated in the model. The outside air infiltration rate was set at 0.3 ach^{-1} during the heating season and 2.3 ach^{-1} otherwise. The internal thermal loads are set as according to the intended use of the building, which is a residential guest house. The building is fitted with a free-standing heating and cooling radiator system.

3. SIMULATION RESULTS

The model of the two construction types is subjected to internal and external load conditions as defined by the occupancy patterns and the weather data. Simulations are carried out for the following conditions.

- Free running, with ventilation rate at 2.3 ach^{-1}
- Intermittent operation: Heating or cooling system turned on between 6-24 h.
- Continuous operation: Heating or cooling system turned on 24 hours at base load, which is calculated from overall energy emitted or removed in order to maintain comfort temperatures during intermittent operation, in kWh per day.

For simplicity, the analysis of the results concentrates on the internal conditions of the lounge, situated on the ground floor facing east, in terms of its resultant or operative temperatures. The lounge has a total floor surface area of 92.3m^2 and room volume of 325m^3 . The thermal response of the building without mechanical services is represented by the resultant temperatures of the lounge shown in Figure 1.

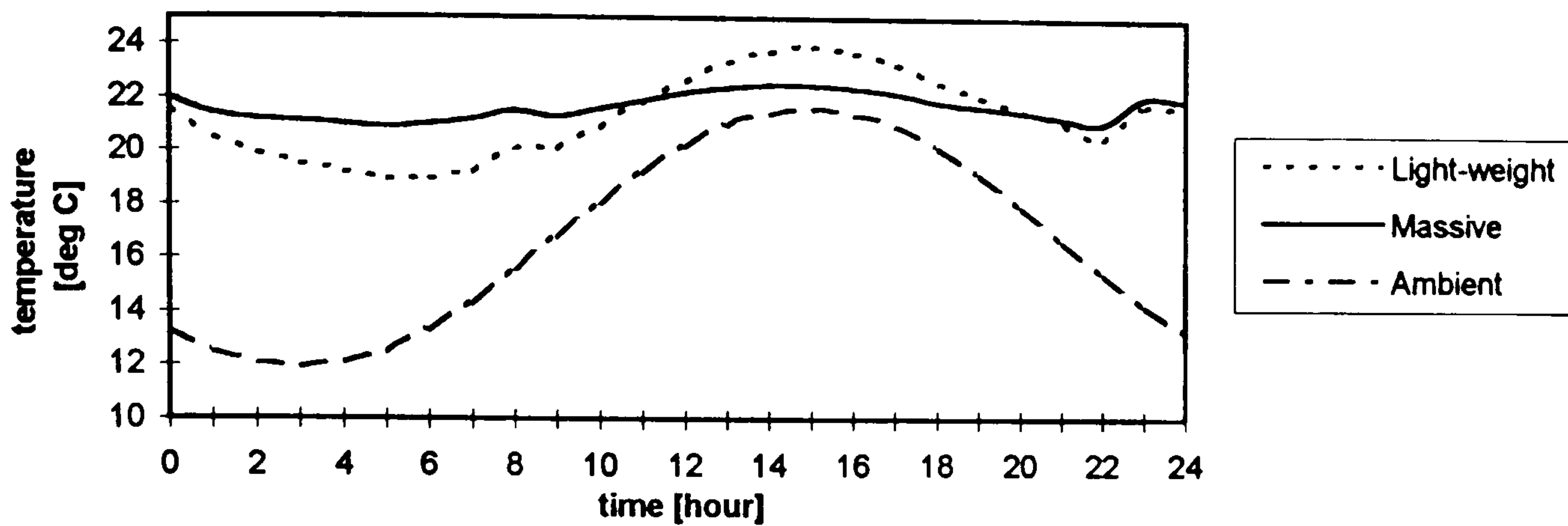

Figure 1. Resultant temperatures of the lounge for the light-weight and massive construction at a free-running mode for a typical day during the transition period (September 23).

In general, the massive building provides a more stable internal environment. The attenuation effect of the thermal mass indicates that the period when mechanical heating is not required may be extended.

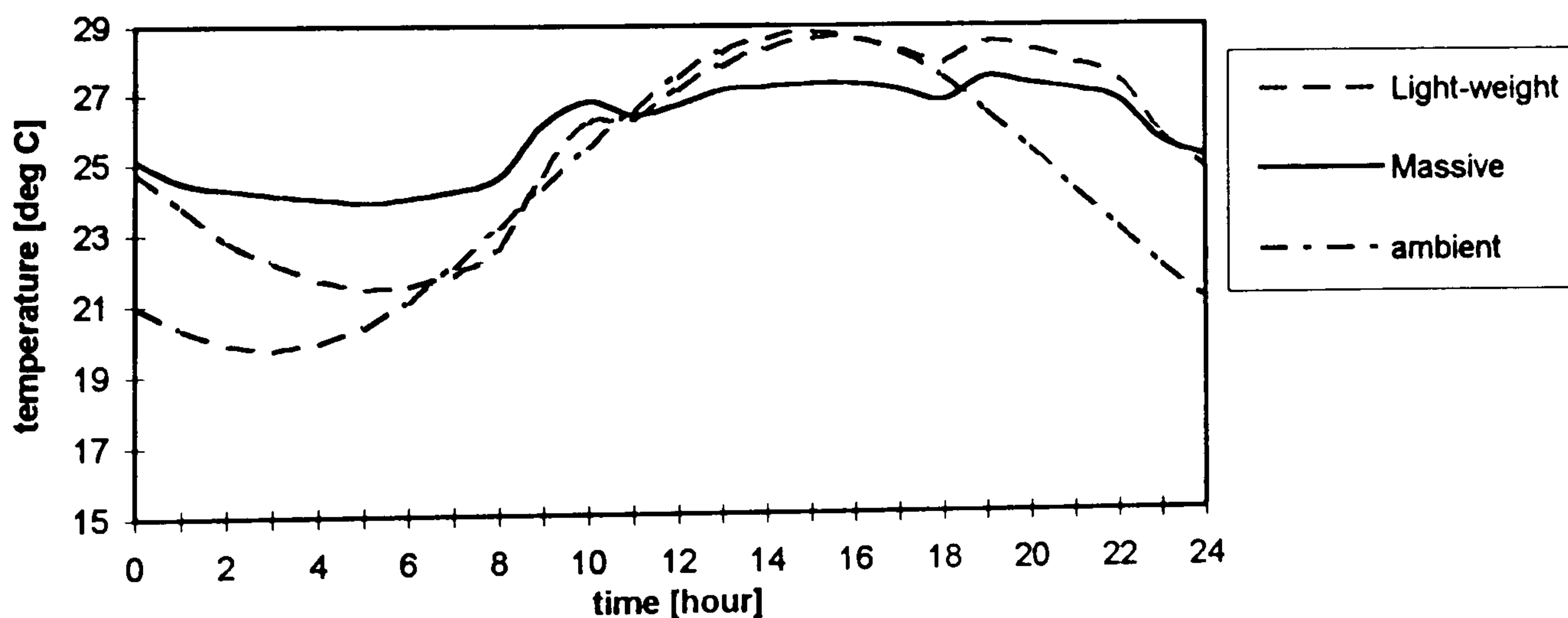

Figure 2. Resultant temperatures of the lounge for the light-weight and massive construction with cooling at 1.2 kW constant at continuous operation for a typical peak cooling period (August 1).

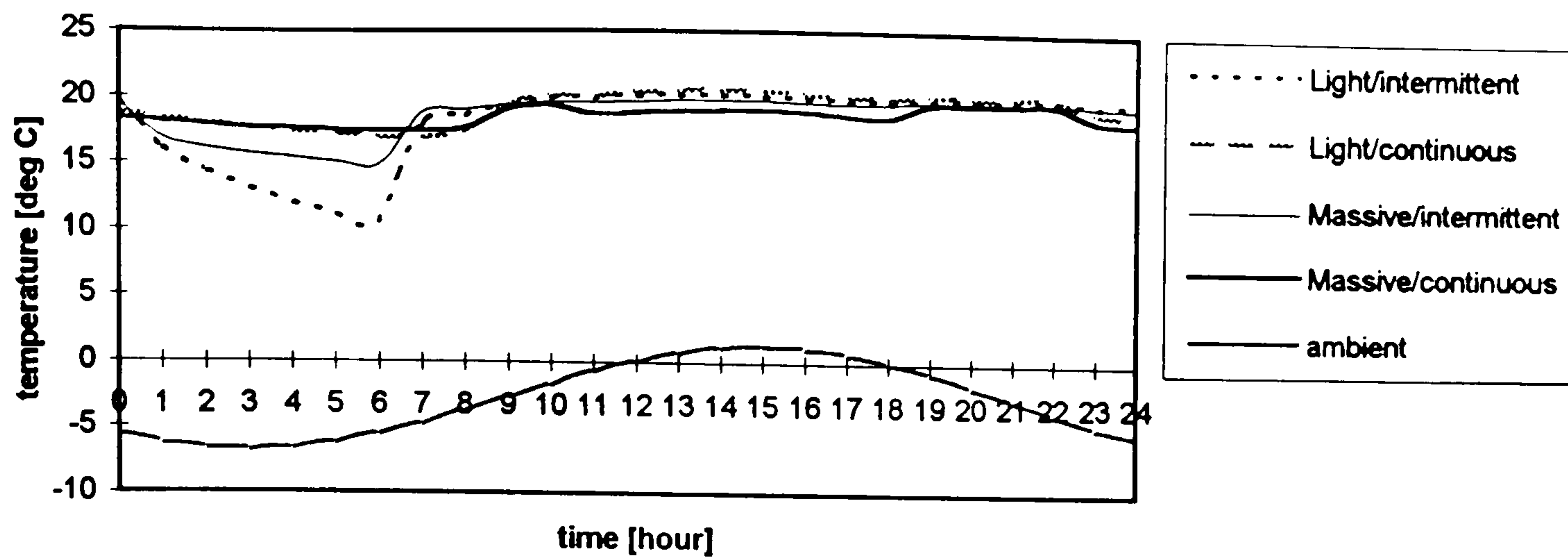
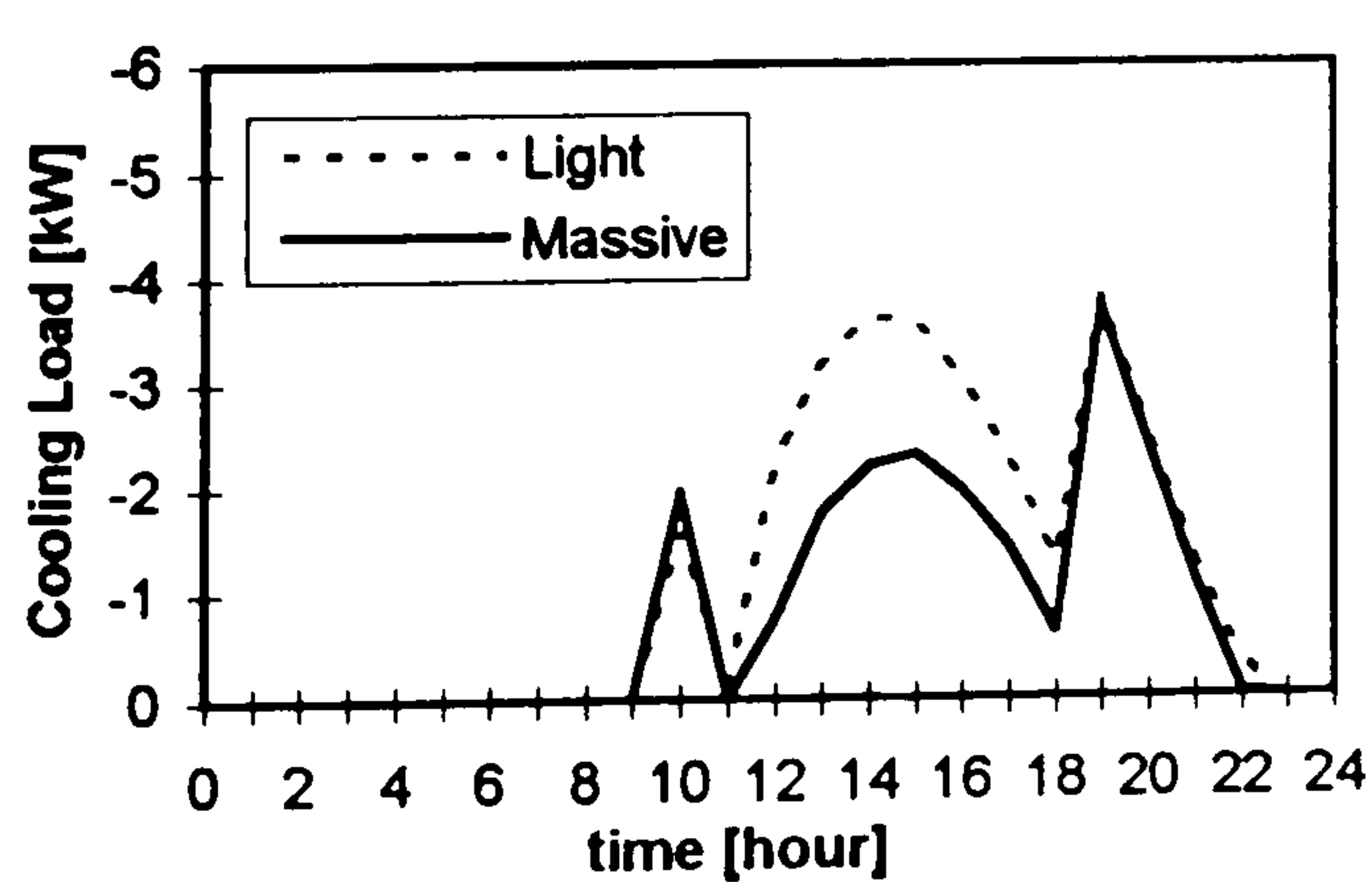
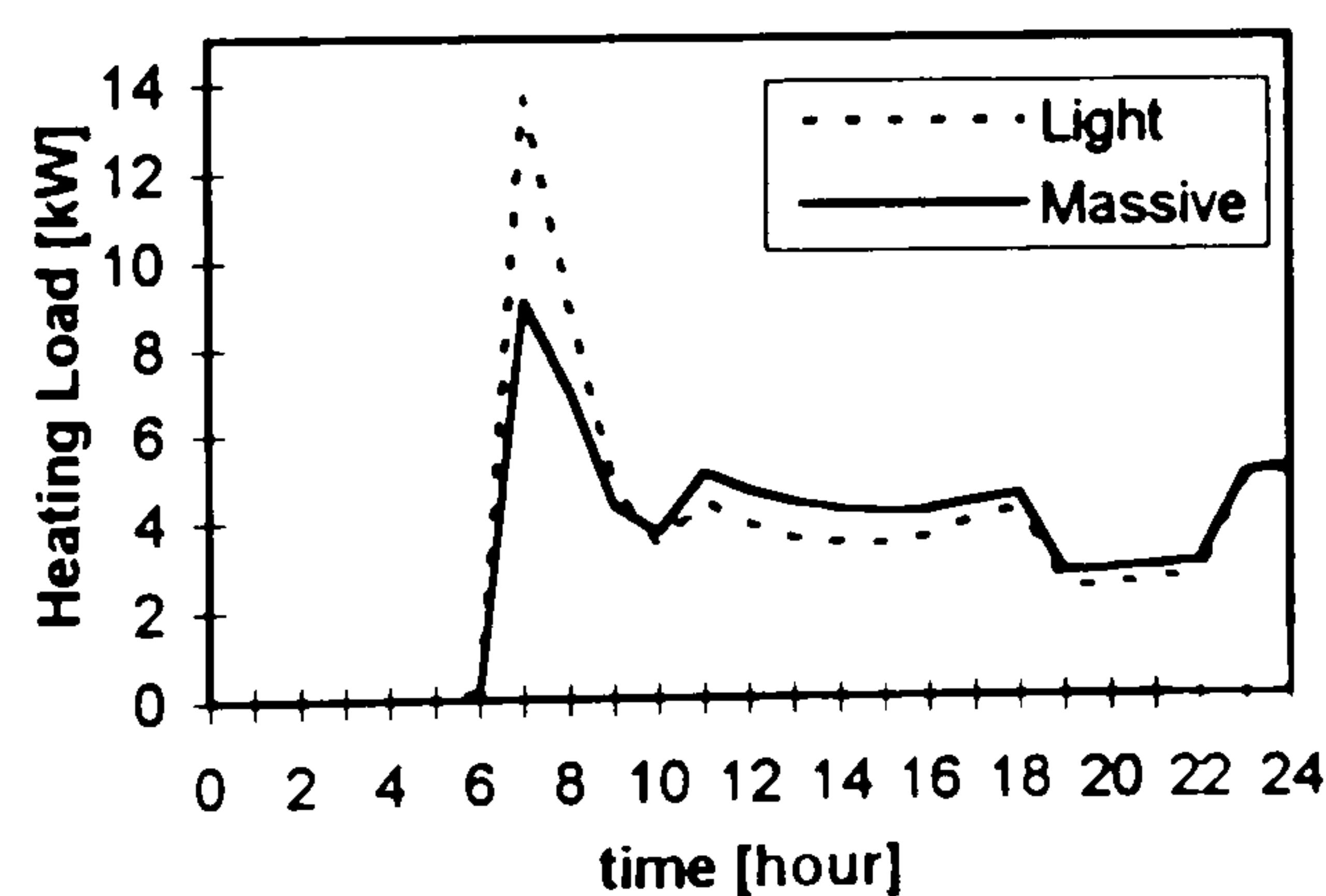

Figure 3. Resultant temperatures of the lounge for the light-weight and massive construction with intermittent heating and continuous heating at 3.4 kW constant for a typical peak heating period (January 23).

Figures 2. and 3. show the internal conditions during the cooling and heating periods. The massive structure show a greater advantage in the internal condition particularly during the cooling season. During the heating season, the resultant temperature for the light-weight construction with intermittent heating falls significantly during the night requiring a higher start-up load in order to achieve comfortable conditions during the day. This would mean a much larger heating system as a consequence. The daily cooling and heating loads required to achieve comfortable resultant temperatures during occupied periods (8 to 24h.) are shown in Figures 4a. and b, respectively. The thermal storage effect of the massive structure is most evident during the cooling period. The massive construction shows a significant advantage in energy efficiency over the light-weight construction as can be seen in Figure 5. The benefit of incorporating thermal mass is also evident in the sizing of the cooling system, particularly with continuous operation, as shown in Figure 6.



(a)



(b)

Figure 4a. and b. Cooling and heating loads of the lounge for a typical summer and winter day.

**PAGE
NUMBERING
AS ORIGINAL**

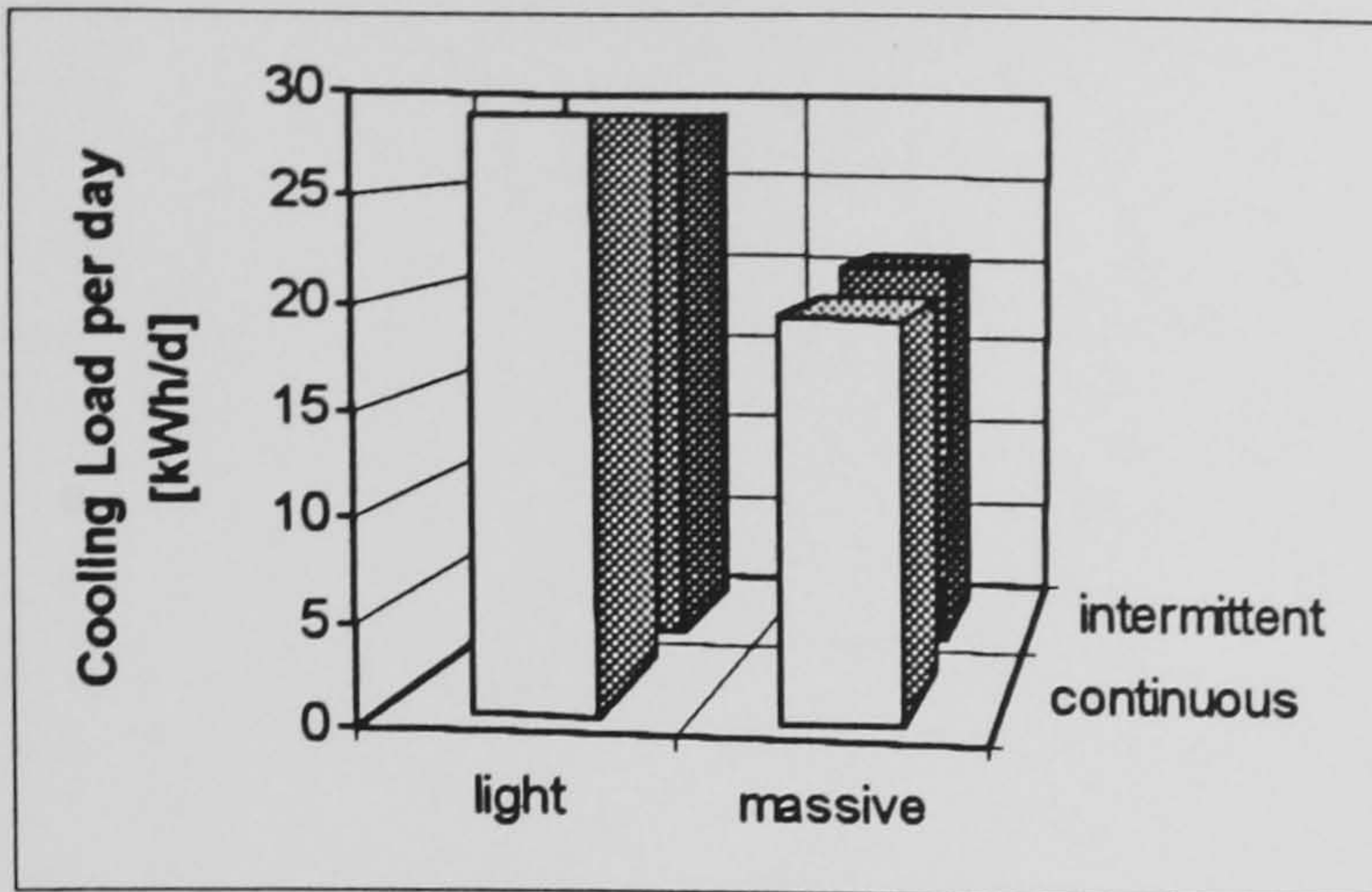

Figure 5. Cooling load for the lounge on a typical summer day, with light and massive construction, intermittent and continuous cooling.

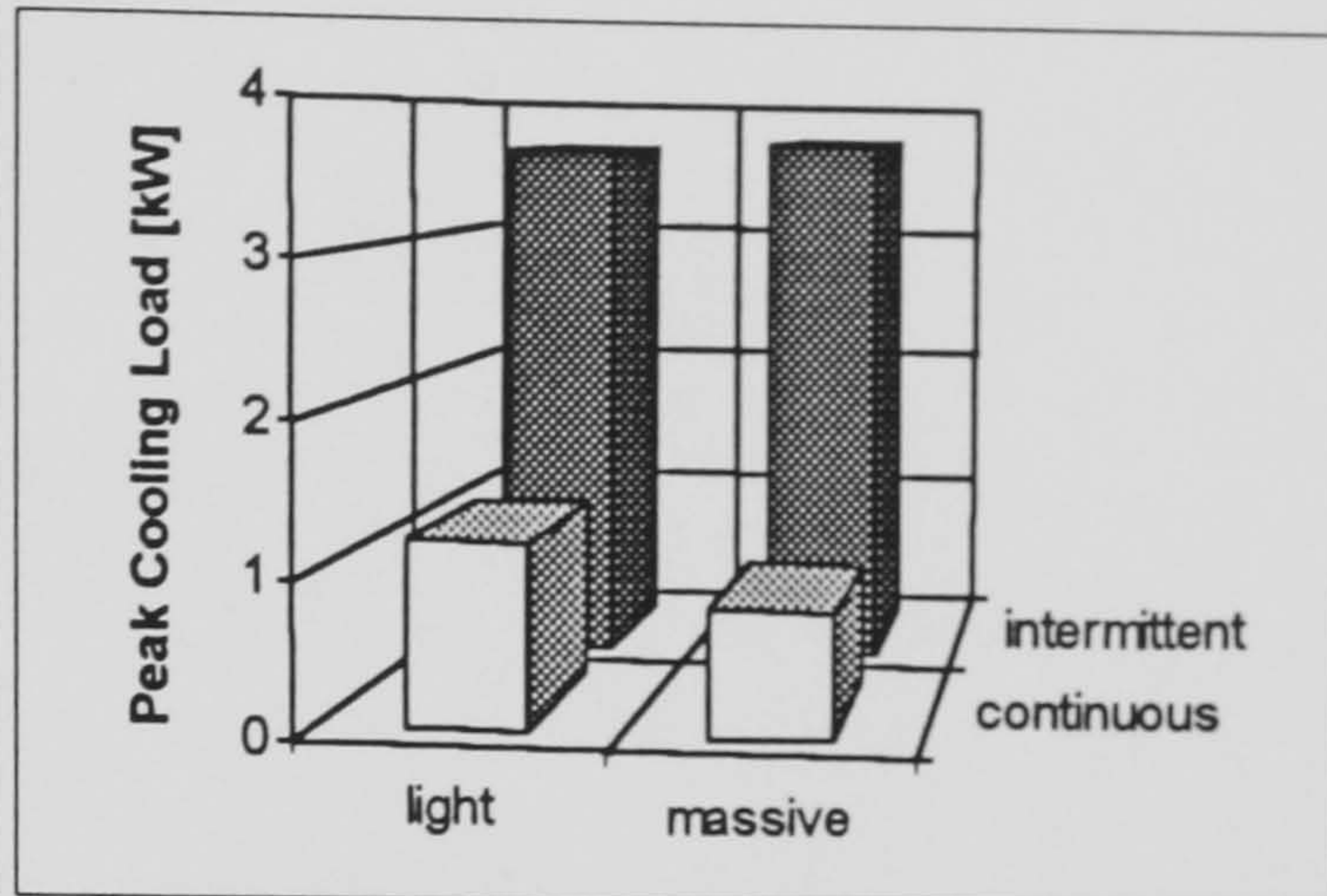

Figure 6. Ideal cooling plant size for the light and massive construction and different operation strategies.

4. CONCLUSIONS

Thermal simulation of a building in the Tohoku Region of Japan using local climatic data has shown that massive construction could be effectively utilised for thermal storage purposes in order to reduce plant size and enhance energy efficiency, without penalties on thermal comfort. It is shown that the operation strategies of the cooling and heating systems are important factors in achieving the aims of utilising building mass effectively. Other factors studied during this investigation have been the effects of surface area of exposed mass to volume ratio of a room and humidity control. Due to the limited space available, these results are not presented. Another vital factor affecting the results would be ventilation rates but they were not thoroughly investigated in this study.

REFERENCES

- ¹ Passive Cooling Effect of a Massive Vernacular House Examined by Field Measurements under Summer Conditions in Japan, Prof. K. Kimura, S. Tanabe, Department of Architecture, Waseda University, Tokyo