

The Fourth International Through-life Engineering Services Conference

## Security aspects in Cloud based condition monitoring of machine tools

Stefano Tedeschi<sup>a\*</sup>, Jörn Mehnert<sup>a</sup>, Nikolaos Tapoglou<sup>a</sup>, Roy Rajkumar<sup>a</sup>

<sup>a</sup>EPSRC Centre for Innovative Manufacturing in Through-life Engineering Services  
Manufacturing Department, Cranfield University, MK43 0AL, UK

\* Corresponding author. E-mail address: {s.tedeschi, j.mehnen, n.tapoglou, r.roy } @cranfield.ac.uk

### Abstract

In the modern competitive environments companies must have rapid production systems that are able to deliver parts that satisfy highest quality standards. Companies have also an increased need for advanced machines equipped with the latest technologies in maintenance to avoid any reduction or interruption of production. Eminent therefore is the need to monitor the health status of the manufacturing equipment in real time and thus try to develop diagnostic technologies for machine tools. This paper lays the foundation for the creation of a safe remote monitoring system for machine tools using a Cloud environment for communication between the customer and the maintenance service company. Cloud technology provides a convenient means for accessing maintenance data anywhere in the world accessible through simple devices such as PC, tablets or smartphones. In this context the safety aspects of a Cloud system for remote monitoring of machine tools becomes crucial and is, thus the focus of this paper.

© 2015 The Authors. Published by Elsevier B.V. This is an open access article under the CC BY-NC-ND license (<http://creativecommons.org/licenses/by-nc-nd/4.0/>).

Peer-review under responsibility of the Programme Chair of the Fourth International Conference on Through-life Engineering Services.

*Keywords:* Cloud; Remote Maintenance; Machine Tool; Secure Communications; Remote Monitoring

### 1. Introduction

This paper describes the development of a secure system for real-time monitoring for machine tools at a distance through the use of a platform for Cloud storage and data communication between the machine user and the service center. Currently with the continued growth of precision mechanics in various industrial sectors and the continued demand for customized products, the use of machine tools is getting stronger. Manufacturing enterprises are being asked to combine high quality products in short time and low number of defects. It also demands that the machine tool can maintain a high overall equipment efficiency (OEE), avoiding prolonged shutdowns that would damage the company's profit. The work is focused on the continuous research of efficiency of machine tools in order to improve the health status of the machines themselves and leave to work as long as possible without stopping. To date old machine tools often do not use the right technology to monitor the health of the machine. When a failure occurs in production, a technician must visit the plant of the customer and fix the problem manually. The

faults that may occur are not always of the same type and therefore the time of intervention will vary. To prevent failure, a system of condition monitoring should be implemented since a well-developed maintenance system allows a company to have a better margin on its direct competitors. The first step required for developing such a system is to optimize product quality and minimize calls to the service centre and increase the efficiency of the service. All this is possible today thanks to current communications technology, such as the Internet that provides full support in connecting the manufacturer of the machine tool with the customer. Through the creation of a safe and secure Cloud system users can exchange information and analyze data. That data may be collected through a data acquisition unit placed on the machine and connected to the network. In this way the service center firstly identifies whether the fault is caused by hardware or software errors and then defines the countermeasures to be taken.

## 2. Research problem

This research is focused on the development of a unit for self-learning data acquisition that transmits real-time information through the internet to a Cloud system. The machine tool system is usually divided into many subsystems and thus different signals are acquired. The tool subsystem includes the tools used in the cutting process. The subsystem plant includes the electrical, hydraulic and pneumatic plants. The software subsystem is composed of the software for the operation. Finally the control subsystem includes the numerical control (NC) drives and reading parameters [1]. The first task is to understand whether to scan all signals of which the machine is equipped or focus attention on the main aspects related to the various subsystems. Given that acquiring vibration signals of overstressing, torsion stress or heat and wear, would be a lengthy and laborious. What is needed instead is an intuitive and easy to use approach that interfaces easily with the user or customer. It is necessary to identify the common causes of degradation of the functional parts. This helps in understanding what signals are required and to what quality. Even after having decomposed the machine tool into subsystems, at the time when damage is detected, the analysis of data may need to recognize further subsystems to better understand the error appearing in the corresponding functional subsystem groups.

## 3. Related work

Today much research has been proposed to develop remote monitoring and maintenance systems (RMMS). Yang et al. [2] developed an Internet-based remote maintenance system for process control. Feldmann and Göhringer [3] have developed Internet-based diagnosis of the mounting system for the maintenance. Lung et al. [4] developed a maintenance tool for decision making. Cunha et al. [5] developed service module production as input for production planning. Mori et al. [1] proposed a practical way to improve the efficiency of maintenance by monitoring and analyzing the state of operation of 8000 machine tools worldwide. Currently in the technical field there are few scientific articles that propose approaches related to the use of data acquisition units that are connected remotely to the service company [6, 7]. The main reason is related to the difficulty of securing communication between the company and the customer service [6]. Despite everything, however, some progress has been made regarding secure communications [8]. With the continued growth of the Internet, many companies open their computer system to partners and suppliers [10]. Thus it becomes important to know the company's resources to safeguard the access controls and authorizations management and users of the computer system.

## 4. Cloud Computing

The term Cloud Computing refers to a series of new technologies that offer the user an innovative management system, with storage and sharing of computing resources that are provided based on demand, through the formula of the

pay-as-you-go using broadband networks. It is a general purpose technology that allows you to replace the hardware and software with online connection to remote data centers, saving costs. The innovation of this technology is the fact that the physical component of the server computer disappear and all data are stored in a easily expandable center made accessible to the customer through the Internet from any device PC, tablet or smartphone [8, 9]. The architecture of a Cloud system can be divided into three categories:

Software as a Service (SaaS): it is the top layer of the infrastructure that contains the applications formed by members of the deeper levels, including programming languages, operating systems, networks, servers and storage systems [8].

Platform as a service (PaaS): placed at the intermediate level of the infrastructure it is a runtime system or software that provides a number of useful services for the execution of a program.

Infrastructure as a Service (IaaS): it is the deepest layer of Cloud infrastructure within which the user, regardless of frontiers of the programming interface and application platform, is responsible for processing, storage, and network management and other IT resources, including which operating systems, storage and distribution of data applications. Cloud Computing can also be used to grow many other aspects of manufacturing business by moving a traditional process to the cloud for improved operational efficiency.

### 4.1. Cloud Manufacturing

Cloud Manufacturing refers to the integration of distributed manufacturing services via the Internet to undertake production activities in a more adaptive and agile way [11, 12]. Cloud computing is seen as the evolution and convergence of several trends of independent calculation, such as Internet delivery "pay-as-you-go" utility computing, elasticity, virtualization, distributed computing, outsourcing content [13]. Similarly Cloud Manufacturing is also considered as a new multidisciplinary domain which includes technologies such as networked production, grid production, virtual production, agile manufacturing, internet of things, and of course, Cloud Computing. Cloud Manufacturing reflects both, the concept of integration of distributed resources and the concept of distribution of integrated resources. The National Institute of Standards and Technology, USA (NIST) defines Cloud Manufacturing as "a model for enabling ubiquitous, convenient, on-demand network access to a shared pool of configurable productive resources (for example, tools software production, production equipment and production capacity) that can be quickly released with minimal management effort or iteration of the service providers" [24]. In Cloud manufacturing distributed resources are contained in Cloud services and managed centrally. Cloud users may require services ranging from product design, manufacturing, testing, and management of all the other stages of the life cycle of the product. A service platform in Cloud Manufacturing performs research, intelligent mapping, the recommendation or the execution of a service.

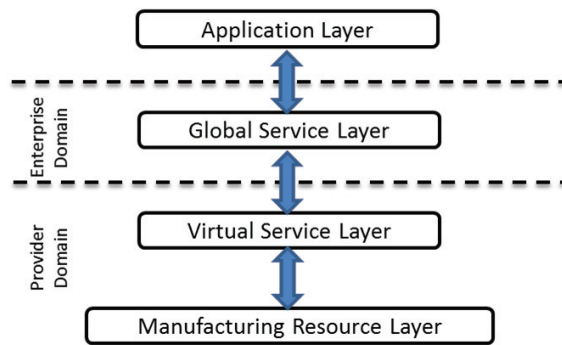

Figure 1: Layer architecture of a Cloud Manufacturing system

Figure 1 show an overview of the system Cloud Manufacturing, which consists of four layers:

- The Manufacturing Resource Layer, which encompasses the resources that are required during the product development life cycle. Can take two forms, manufacturing physical resources and manufacturing capabilities. The manufacturing physical resources include equipment, computers, server, and raw materials. The manufacturing capabilities are dynamic recourses representing the capability of an organization undertaking a particular tasks, includes product design capability, simulation capability, experimentation, production capability, management capability and maintenance capability.

- The Virtual Service Layer, where the key functions are to: identify manufacturing resources, virtualized them, and package them as Cloud Manufacturing services. A different technology can be used for identifying manufacturing resources [14, 15], Radio Frequency Identification (RFID), wireless sensor network (WSN), Cyber Physical Systems, GPS, sensor data classification, clustering and analysis, and adapter technologies. Different manufacturing resources are virtualized in different ways. Manufacturing hardware is usually mapped to become virtual machines that are system independent. Agents can be effective tools for virtualization. For example MT Connect [16] is a standard based on an open protocol for data integration.

- The Global Service Layer relies on a suite of Cloud deployment technologies. It is based on the nature of the provided Cloud resources and the user's specific requirements, two types of Cloud Manufacturing operation modes can take place at the Global Service Layer, complete service mode and partial service mode.

- The Application Layer server as an interface between the user and manufacturing Cloud resources. This layer provides client terminals and computer terminals. The user can define and construct a manufacturing application through the virtualized resources. Very important in Cloud Manufacturing is the issue of privacy. The primary concern of users is related to the storage of sensitive personal or business data. This includes information related not only to products but also on production flows, product specifications, procurement. There are some technologies that can improve data integrity, and

confidentiality and security of Cloud Manufacturing [17]. They are:

- Data compressing and encrypting at the storage level
- Virtual LANs, that can offer secure remote communications
- Network middle-boxes (e.g., firewalls, packet filters), for failsafe communication

Cloud Computing is changing the way companies do their business. With the wider adoption of Cloud, access to business-critical data and analyzes become available that help companies to stay ahead of the technology. In addition, Cloud Computing is emerging as one of the key enabling factors for the manufacturing industry, transforming its business models, helping to align product innovation with the business strategy, and the creation of intelligent enterprise networks that encourage collaboration effectively.

## 5. Remote maintenance

In recent years, many control systems have been installed in process plants [24]. The challenge is to maintain the optimum performance of existing systems. The motivation for the construction of such systems of remote maintenance is to provide an efficient support for these control systems, which are characterized by being present both within the process plant, and in some cases geographically distant. Remote maintenance systems enable companies with multiple sites in different locations to access, analyze and react to information quickly and efficiently than ever before. It also allows companies to delegate the maintenance of a service company or software vendors in remote, without the need for in-house experts. In reality this is seen as the best means to control various software components of the control system from a remote location [6].

### 5.1. Remote monitoring and maintenance system for machine tools

RMMS is a system for manufacturers of machine tools to monitor and keep under control machine tools of their customers remotely. The developed system is able to reduce downtime and reduce the customer's service time. To create an RMMS it is necessary to determine specific requirements.

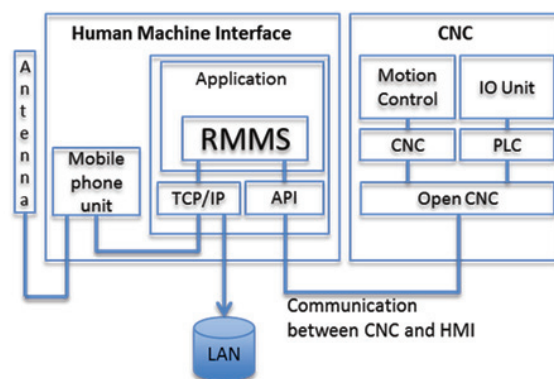

Figure 2: The connection the communication device and HMI of CNC

When a problem occurs with a machine tool, the maintenance manager must be able to warn the manufacturer. The manufacturer must be able to have the details of the situation from a remote location. It must be allowed access security to the system RMMS, as they are not allowed malicious attacks on the Internet that may in any way damage the maintenance system. Furthermore RMMS must be able to perform the analysis of the quality of the operating state of the machine tool. For example, the historical data collected should be available for the companies so that they can use this data in production management [6]. The communication between the machine, the tool builders and their customers is the key to establishing a successful RMMS. Figure 2 presents the RMMS architecture; the operator of CNC on each machine tool controls the communication between itself and the remote manufacturer's server via TCP/IP protocol. The server of the remote assistance service processes thousands of requests for communication of machine tools customer. RMMS is the main method to transfer the operating status of the machine tool by sending email notifications. The information is stored in a buffer zone of the CNC. The CNC sends email when: the buffer reaches a certain level or when spent a lot of time the last transmission, or because there is an emergency situation. For the data on the security of communications will be encrypted before being transmitted as an e-mail. After receiving the e-mail, the server of the machine tool manufacturer decodes and stores the records in the database [6].

### 5.2. Condition Based Maintenance

The goal of Condition Based Maintenance (CBM) is to assess and predict the state of the health of the components of a machine so as to prevent or minimize the impact of any failure in the machine. Its purpose is to reduce the number of unexpected errors maximizing intervals repair and minimizing costs [6]. CBM Systems can be used by handheld devices where an operator physically controls specific components of a machine or acquisition and signal processing system. However, data collection could overwhelm the database and cause difficulty to extract the necessary information. The goal of a computerized monitoring system should be to collect data important and useful, easy to manage for the benefit of the customers [18]. A typical computerized monitoring system usually consists of four main components: sensors, a microprocessor system or data acquisition (DAQ), a host computer, and software programs [19]. The different sensors capture the characteristic signals (vibration, temperature). These signals can be sent to the computer on-board the machine, or to an acquisition unit that converts these signals into data. These data are then sent to a central server and made available to all authorized devices. Data can also be transmitted to the DAQ via wireless sensors [20]. A scheme of the system including many of these components discussed is shown in Figure 3.

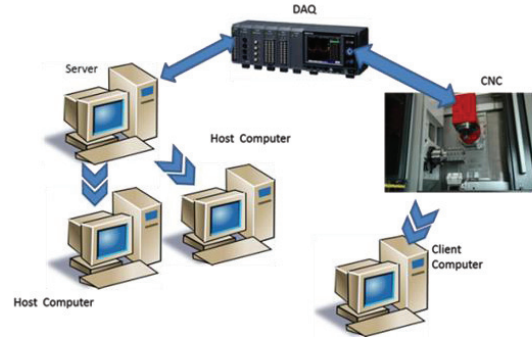

Figure 3: A typical CBM system architecture

### 5.3. Reconfigurable Prognostics Platform (RPP)

In literature several proposes to suppose CBM through data acquisition unit have been made. To illustrate the current developments in this field the work by [21] shall serve here as a good example. This DAQ can be installed on the equipment and has the ability to convert data into information of performance. The information of the service can be integrated into the system of enterprise asset management decisions for future maintenance [21]. The RPP is a platform that integrates hardware and software and is used to convert data into information of performance through a toolbox called Watchdog Agent® [22].

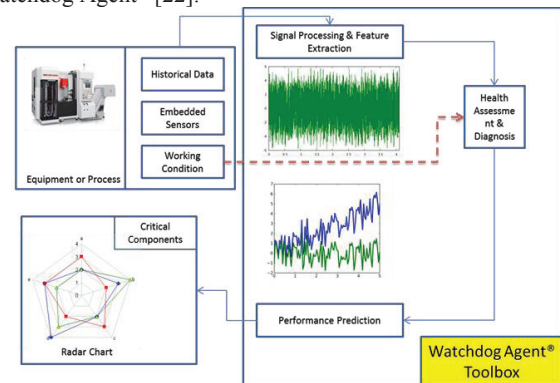

Figure 4: Flowchart of Watchdog Agent® [7]

The platform uses information technology, communications and data analysis to evaluate and predict the performance of the equipment. The toolbox Watchdog Agent® is able to convert the data on the machines in health functions related to performance and quantitatively evaluate the performance of the machine.

In Figure 4, the data can be obtained from sensors integrated on the machine tool. These data are processed in multiple selecting appropriate algorithms for signal processing. In this way you can compare real-time data with historical ones, evaluate data and information of machine health and define the optimization plans [7].

## 6. Idea proposed

The goal is to develop a monitoring system for the retrofit of machine tools to support remote maintenance. New information technologies revolutionizing manufacturing are Cloud Computing and the Internet of Things. Obviously the basis of this new philosophy is the concept of sharing information and the possibility to access information from a variety of devices. This new technology greatly influences the IT scenario worldwide, from resource that can create a competitive advantage or essential asset for business. However, with the use of this new information technology, companies are subject to different threats from the IT world. It is therefore extremely important for companies to use safe channels, to protect sensitive data, which could in some way damage the business profit. This is the reason for the development of a data acquisition unit for collecting information from the machine tool which must be fast and efficient and can be used for various machine tools.

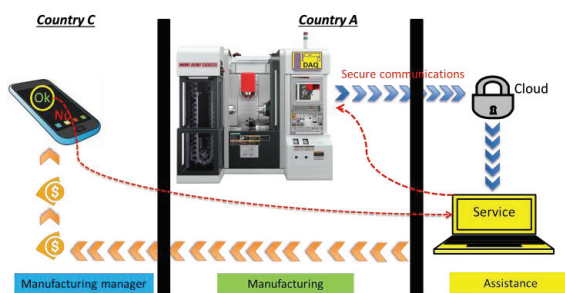

Figure 5: Overview of cyber secure cloud based remote maintenance

Figure 5 presents an overview of the idea proposed in this research. In particular, the scenario is divided for illustration purposes of the power of this approach into three geographical areas: the production company present in country A with the data acquisition unit (DAQ) mounted on the machine tool collecting data during production. This production company is in contact with the service company located in country B communicating through a secure Cloud. Once the company has collected operations data, the service performs checks of the state of health of the machine tool. When or even before the service company finds or predicts a malfunction in the machine tool, it informs the production company manager in country C and suggests instantaneously useful services to reduce cost and time for repair. The production company manager also receives the information necessary to understand the cause of the disruptions and how the services would mitigate these. Once the manager accepted the service, the service company can initiate the remote service and re-establish or secure a continuously running process.

### 6.1 Design of a secure cloud computing based remote maintenance tool

The practical proposed system incorporates both, a part of software and hardware. The platform uses computer technology, communication and data analysis to evaluate and

predict the performance of the equipment. Treatment and methods of self-diagnosis advanced data are developed to facilitate the approach to this architecture, so that it can be adjusted easily and quickly with minimal human intervention.

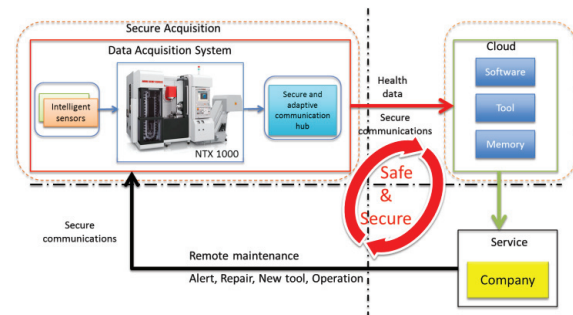

Figure 6: First model with data analysis within the DAQ

As shown in Figure 6, the architecture is divided into four blocks. The first block is the toolbox of units of data acquisition (DAQ). The data are captured by intelligent sensors on machine tools, evaluating those that are the working conditions. Inside the DAQ through secure communication channels like HTTPS that combines iteration of the HTTP protocol through a mechanism of encryption such as Secure Sockets Layer (SSL), the acquired data are transferred to the Cloud system. The SSL protocol provides connection security guarantees [23]:

- Authentication (security identity of the subjects that communicate)
- Data confidentiality (protection of data from unauthorized observers)
- Data integrity (security that the data received is equal to the datum sent)

Inside the DAQ we find a system for the conversion of the acquired signals from intelligent sensors into numerical values, for the analysis and evaluation of the data compared to those which are usually the common values of operation of the machine. In the Cloud platform there are a tool of data protection recognition software yet for unauthorized users to control the privacy as the access management system, anti-virus, firewall, authentication, access protocol or network keys, and, finally, a memory for temporary storage of data. The next stage provides access of the service company to the Cloud to be able to recover data related to the machine tool. Important for the security of the information is that the company's service has a single and secure access to the Cloud system once they are sent to the machine data. Once the data is collected, the service will execute what is an assessment of the health status of the machine tool under consideration, through a comparison between those who are the real data and those initials relating to the initial commissioning of the machine. After evaluating the data the service company will communicate the report to the production company, and if there were some incongruities with what is the normal operation of the machine, execute them where possible of repair work, calibration of the machine. The service company can also in real time provide the production company with

information for planning of the maintenance that should be performed.

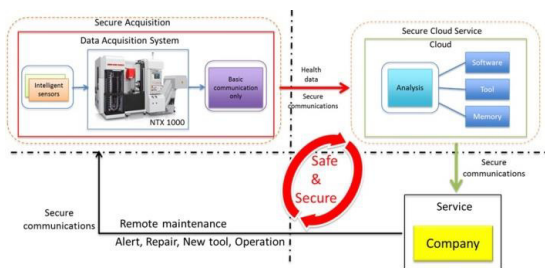

Figure 7: Second model with data analysis within the cloud

The system shown in Figure 7 is very similar to the version shown in Figure 6. However, this solution is different in the way where the data is analyzed. In this case analysis is carried out inside the Cloud itself rather than at the machine; this solution avoids the sending large amounts of raw signals to the Cloud. This also avoids sending potentially vast amounts of sensitive data around the globe to the Cloud, thus decreasing the risk of any eavesdropping along the way between Cloud and DAQ.

## 7. Conclusion

This paper lays the foundation for the realization of a methodical approach for preventive maintenance with the realization of a data acquisition unit capable of self-learning during the run-time of a machine tool. The data acquisition unit will make any measurement data available through a ubiquitous secure Cloud system in all parts of the world to authorized users. Being in the initial phase of this research we propose a methodical approach to acquire signals from the machine tool in the plant so as to evaluate aspects of measurement reliability and repeatability. In future developments we will elaborate further on the safety aspects of the DAQ software as well as building a secure hardware unit for physical securing communication to the Cloud.

## Acknowledgements

This work is being undertaken with the EPSRC, grant number EP/I033246/1 and collaboration with the group Kennametal and will be conducted in the EPSRC Centre for Innovative Manufacturing in Through-life Engineering Services. Many thanks also to DMG Mori who made the CNC turn-mill centre NT1000/W available for this research.

## References

[1] G. Malagola, G. Morandi (2006) "Qualification of maintenance personnel in small businesses specialized" *Maintenance Technical and Management*, Year XIII, No. 9  
 [2] S.H. Yang, Ch. Dai, and R.P. Knott (2007) "Remote Maintenance of Control System Performance over the Internet" *Control Engineering Practice*, Vol. 15(5): 533-544.  
 [3] K. Feldmann, J. Gohringer (2001) "Internet based Diagnosis of Assembly Systems" *Annals of the CIRP*, 50(1):5-8.

[4] B. Lung, M. Veron, M.C. Suhner, A. Muller (2006) "Integration of Maintenance Strategies into Prognosis Process to Decision-Making Aid on System Operation" *Annals of the CIRP*, 54(1):5-8.  
 [5] P.F. Cunha, J.A. Caldeira Duarte, L. Altling (2004) "Development of a Productive Service Module Based on a Life Cycle Perspective of Maintenance Issues" *Annals of the CIRP*, 53(1):13-21.  
 [6] M. Mori, M. Fujishima, M. Komatsu, B. Zhao, Y. Liu (2008) "Development of remote monitoring and maintenance system for machine tools" *Annals of the CIRP*, 57:433-436  
 [7] L. Liao, J. Lee (2010). "Design of a reconfigurable prognostics platform for machine tools" *NSF I/UCR Center for Intelligent Maintenance Systems Department of Mechanical, Virginia, US*. Vol. 37: 240-252  
 [8] B. Wang, Y. Zheng, W. Lou, Y. Th. Hou (2015) "DDoS attack protection in the era of cloud computing and Software-Defined Networking" *Computer Networks*, 81: 308-319  
 [9] L.M. Vaquero, L. Rodero-Merino, J. Caceres, M. Lindner (2009) "A Break in the Clouds: Towards a Cloud Definition" *Telefonica Investigacion y Desarrollo and 2 SAP Research*, 39 (1):50-55  
 [10] G. Phalguni, P. Surya, J. Umarani (2010) "It Infrastructure & Its Management" *Tata McGraw Hill*: 114-144  
 [11] B.-H. Li, L. Zhang, S.-L. Wang, F. Tao, J.W. Cao, X.-D. Jiang, X. Song, X.-D. Chai (2010) "Cloud manufacturing: a new service-oriented networked manufacturing model" *Computer Integrated Manufacturing Systems, CIMS*, 16(1):1-7.  
 [12] F. Tao, Y. Hu, L. Zhang (2010) "Theory and practice: optimal resource service Allocation in manufacturing grid" *China Machine Press*. ed.1<sup>st</sup>: 1-18  
 [13] G. Pallis (2010) "Cloud computing: the new frontier of internet computing" *IEEE Internet Computing*, 14 (5):70-73.  
 [14] G. Huang, Y. Zhang, P. Jiang (2007) "RFID-based wireless manufacturing for walking worker assembly islands with fixed-position layouts" *International Journal of Robotics and Computer Integrated Manufacture*, 23(4):469- 477.  
 [15] G. Huang, P. Wright, S. Newman (2009) "Wireless manufacturing: a literature review, recent developments and case studies" *International Journal of Computer Integrated Manufacturing*, 22(7):1-16.  
 [16] J. Michaloski, B. Lee, F. Proctor, S. Venkatesh, S. Ly (2010) "Quantifying the performance of MTConnect in a distributed manufacturing environment" *Proceedings of the ASME International design engineering technical conferences and computers and information in engineering conference*, Vol. 2 (PART A): 533-9  
 [17] B. Rimal, A. Jukan, D. Katsaros, Y. Goeleven (2011) "Architectural requirements for cloud computing systems: an enterprise cloud approach" *Journal of Grid Computing*, 9: 3-26  
 [18] S. D. Lund (2003) "Monitoring Machines and Processes to Improve Manufacturing Operations" in *SAE Aerospace Automated Fastening Conference and Exhibition*, Montreal, Canada: 1-3  
 [19] A. Werner, P. Mehta, L. Mears (2011) "Development of a condition based maintenance program for a CNC machine: Part 1 -Signal acquisition, processing, and network communication" *ASME 2011 International Manufacturing Science and Engineering Conference*: 243-251  
 [20] I. P. S. Ahuja, and J. S. Khamba, (2008) "Total productive maintenance: literature review and directions" *International Journal of Quality & Reliability Management*, 25(7): 709-756  
 [21] L. Liao, J. Lee (2010) "Design of a reconfigurable prognostics platform for machine tools" *Expert Systems with Applications*, 37:240-252  
 [22] D. Djurdjanovic, J. Lee (2003) "Watchdog agent - An infotonics-based prognostics approach for product performance degradation assessment and prediction" *Advanced Engineering Informatics*, Vol. 17 (3-4): 109-125.  
 [23] C. Parshotam, C. Rupinder, G. Aayush (2012) "Improving the Secure Socket Layer by Modifying the RSA Algorithm" *International Journal of Computer Science, Engineering and Applications (IJCSA)* vol. 2(3): 79-86  
 [24] Xun Xun (2012) "From cloud computing to cloud manufacturing" *International Journal of Robotics and Computer-Integrated Manufacturing*, Vol. 28: 75-86

2015-10-27

# Security aspects in cloud based condition monitoring of machine tools

Tedeschi, Stefano

Elsevier

---

Stefano Tedeschi, Jörn Mehnen, Nikolaos Tapoglou and Roy Rajkumar. Security aspects in cloud based condition monitoring of machine tools. *Procedia CIRP*, Volume 38, 2015, pp47-52.

Proceedings of the 4th International Conference on Through-life Engineering Services

<http://dx.doi.org/10.1016/j.procir.2015.07.046>

*Downloaded from Cranfield Library Services E-Repository*