

Restart time correlation for core annular flow in pipeline lubrication of high-viscous oil

Aniefiok Livinus¹ · Hoi Yeung¹ · Liyun Lao¹

Received: 10 September 2015 / Accepted: 13 March 2016 / Published online: 28 March 2016
© The Author(s) 2016. This article is published with open access at Springerlink.com

Abstract One of the fundamental questions that must be addressed in the effective design and operation of pipeline lubrication of heavy oil is; “how much time will be needed to restart a blocked core annular flow (CAF) line after shutdown due to fouling or pump failures”, if the pipe is to be cleaned using water only. In this work, laboratory results of shutdown and restart experiments of high-viscous oil conducted in a 5.5-m-long PVC horizontal pipe with internal diameter of 26 mm are first presented. A new correlation for the prediction of the restart time of a shutdown core annular flow line is then formulated. The predictive capabilities of the correlation are checked against measured restart time and pressure drop evolution data. Somewhat high but still reasonable predictions are obtained. The restart time correlation, together with the associated correlations formulated as well, can be of practical importance during the engineering design of high-viscous oil pipeline transportation facility for predicting restart process.

Keywords CAF · Heavy oil · Restart · Water assist flow · Pipeline transport

Abbreviation

C_w Water input fraction

✉ Aniefiok Livinus
anique009@yahoo.com; a.livinus@cranfield.ac.uk

Hoi Yeung
h.yeung@cranfield.ac.uk

Liyun Lao
l.lao@cranfield.ac.uk

¹ Flow Process Assurance, School of Energy, Environment and Agrifood, Cranfield University, Cranfield, UK

| | |
|---------------|---|
| ρ_w | Water density, kg/m ³ |
| ρ_o | Oil density, kg/m ³ |
| μ_w | Water viscosity, kg m ⁻¹ s ⁻¹ |
| μ_o | Oil viscosity, kg m ⁻¹ s ⁻¹ |
| U_{sw} | Superficial velocity of water |
| U_{so} | Superficial velocity of oil |
| h_o | Oil holdup |
| ΔP_i | Initial pressure drop at inception of restart process, Pa |
| $\Delta P(t)$ | Pressure drop evolution at time, t , during restart process, Pa |
| ΔP_w | Pressure drop of a single-phase water flow, Pa |
| L | Length of blocked pipeline, m |
| Δt | Restart time, s |
| t | Time during the restart process, s |
| t^* | Time when pressure drop evolution trend deviates from part a to part b, s |
| V_D | Volume of fluid in blocked pipeline to be displaced, m ³ |
| V | Volume of water used during the restart process, m ³ |
| f_w | Frictional factor for single-phase water flow |
| Re | Reynolds number |
| τ_w | Shear stress of water, Pa |
| τ_o | Shear stress of oil, Pa |
| τ_i | Interfacial shear stress, Pa |
| S_i | Wall-wetted perimeter of interface of oil and water, m |
| S_o | Wall-wetted perimeter of water, m |
| S_w | Wall-wetted perimeter of oil, m |
| A_o | Area of oil phase in pipe, m ² |
| A_w | Area of water phase in pipe, m ² |
| CAF | Core annular flow |
| WAF | Water assist flow |
| PVC | Polyvinyl chloride |

- Z a-part of slope of transient pressure drop of the restart process, constant
- Y b-part of slope of transient pressure drop of the restart process, constant

Introduction

The world's oil resources are majorly heavy and extra heavy viscous hydrocarbons; they make about 70 % of the world's total oil resources of 9–13 trillion barrels. Considering the enormous world energy demand and the continuous decline of conventional oils, heavy oil promises to play a greater role in the future of the oil industry. Many countries are moving now to increase production, test new technologies and invest in pipeline facilities to ensure that these resources are being produced, transported and processed. Due to their very high viscosity, heavy crude oils cannot be transported with conventional pipelines and thus require additional treatments. Research articles by Saniere et al. 2004, Ghosh et al. 2008, Adewusi and Ogunsola 1993, Ngan et al. 2007 show that various methods, as presented in Fig. 1, of reducing the pressure drop have been studied; these include thermal method, addition of diluent, chemical and water assist. Of these, water assist flow (WAF), or core annular flow (CAF) as it is commonly called, seems to be the most environmentally friendly approach.

The operation of oil production or transportation line in the core flow mode consists in injecting small amounts of water to create a lubrication layer around the viscous oil and avoid oil–wall contact. The resulting annular flow pattern reduces drastically the friction pressure gradient, allowing the oil to be pumped up to the surface at a flow rate similar to single-phase water flow (Vanegas and Jose 1999). However, there are some fundamental questions that must be addressed in the effective design and operation of pipeline lubrication of heavy oil as pointed out by

Oliemans and Ooms (1986) and Strazza and Poesio (2012): “What is the velocity range for the co-injection of the oil and water into the pipeline?”, “What pressure gradient has to be applied in order to restart the core annular?” and “What is the restart time needed after shut down?”

Since the first successful recorded large-scale industrial pipeline lubrication of heavy oil, several studies have been dedicated to the CAF science and technology. A good number of experimental and theoretical studies have been carried out, models formulated to describe the flow pattern, and the specific range of velocity where this interesting flow regime is stable (Joseph et al. 1997). The pressure drop reduction for this flow regime has also been pointed out (Joseph et al. 1997; Brauner 2004; Bensakhria et al. 2004; Peysson et al. 2005). Stability of CAF has also been studied showing the interface between the annulus and the core (see Joseph and Rennardy 1993). The long-term stability of this technique requires minimization of fouling (i.e. oil adhesion) of the pipe wall, which causes a reduction in the useful diameter of the pipe (Ramos and Antonio 2001).

With the vast studies on CAF, only very little attention has been paid to answering the questions pertaining to shutdown and restart of a CAF line.

For transportation of large volumes of heavy crude oil, pipeline is known to be the most economic and feasible means. For efficient operation of a CAF line, it is expedient to maintain an uninterrupted steady and continuous flow. However, due to shutdown which may occur as a result of operational or emergency reasons, the CAF regime cannot be maintained. The water settles down on the bottom of the pipe while the oil floats to the upper part stratifying the flow pattern due to difference in density. Even after the initiation of a CAF, there are mechanisms that may be responsible for the transition back to a stratified flow, e.g. the fouling of the pipe wall; as this continues to prevail, a layer of oil grows at the wall reducing the internal diameter of the pipe and eventually blocks the line. A high pressure drop will occur. This has been experienced in the San Tomé 1-km test loop (see Fig. 2 as reported by Arney et al. 1996). The pressure drop increases from 25 to 175 psi.

Fig. 1 Heavy oil transportation method

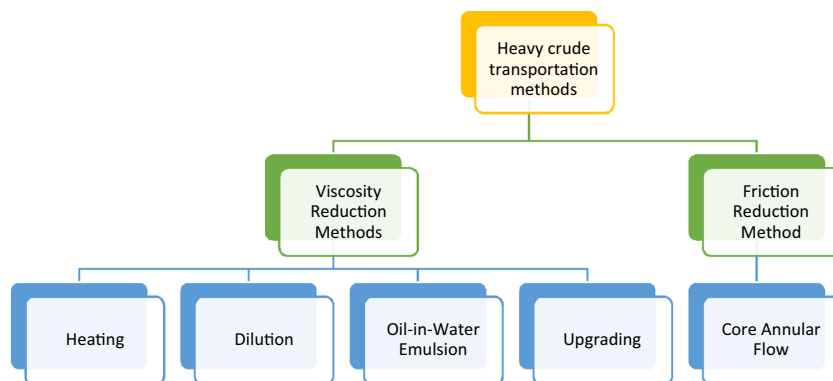

Arney et al. (1996) investigated the fouling mechanism on various pipe materials and reported that the steel normally used for oil pipeline transportation is highly susceptible to fouling because of its lipophilic nature. Fouling can be reduced by acting on the oil chemical properties as reported by Santos dos et al. (2006) and also through the modification or treating of the pipe surfaces (Silva da et al. 2006). Even when additives or pipe surface treatment are adopted, fouling may occur causing huge economical loss if not properly dealt with. Pigging operation offers a solution to solve fouling problems; however, quantification of its effectiveness is impossible.

Shutdown and restart studies of CAF

A simpler approach for solving and studying the restart is the method suggested by Zagustin et al. 1988, where water is used to completely clean up the pipe. The main advantage is the possibility to estimate the effectiveness of the procedure and the influence of parameters. When this approach is adopted, the pressure drop evolution shows a particular relationship with time; this relationship has been described as exponential by Arney et al. (1996), Barbosa et al. (2005), Poesio and Strazza (2007), and Strazza and Poesio (2012).

Another method is to restart the oil and water pumps at the same time at reliable pressure gradient. To restart, a high pressure is needed to shear the oil at the wall. The deformation of the viscous core, which tends to stratify the flow, is very slow compared to the up flow of the oil core in the water. Peysson et al. 2005 have performed an experimental study about the entire restart problem using this sequence. They measured the pressure drop; they also investigated the effects of chemicals (e.g. brines) on pressure drop development during start-up.

Only a very small quantity of data on the pressure drop evolution with time concerning the restart of CAF is available in the open literature (Barbosa et al. 2005; Poesio

and Strazza 2007; Bannwart et al. 2007; Strazza and Poesio 2012). The interest, therefore, in the restarting of a core annular flow from a probably stratified configuration, emanating after shutdown operations for maintenance or due to pump failure, will continue to get more attention in recent times to improve CAF technology.

In this work, the experimental results of the pressure drop trends as a function of time to find when the pipe surface is nearly without oil layer, or at least, when the pressure drops are low enough to restart the oil core annular flow line by flowing water only are first presented. The results are used to develop a realistic correlation of the restart process. Results of the comparisons between experimental data and the new correlations are provided.

Experimental setup and procedure

The section of the 1-inch multiphase flow test rig facility as shown in the schematic of Fig. 3, located at PSE laboratory in Cranfield University, was used to perform the experiments. The test section setup consists of a flow loop with tanks for water and oil storage, a 5.5-m-long PVC pipe with 26 mm internal diameter, transducers for pressure, temperature and differential pressure measurements, Lab View data acquisition system, Pumps and a Chiller to achieve the desired oil viscosity. Pressure measurements were made through two pressure transducers, 2.21 m apart, located before and after the observation section. The experimental conditions for the shutdown and restart experiments are provided in Table 1.

The experiment procedures consist of first establishing a stable oil–water core flow in the horizontal test section of the facility by introducing into the pipe, through a ‘T-Junction’ inlet, oil and water with superficial oil and water velocities of 0.4–0.5 m/s and 0.2 m/s, respectively. Both oil and water pumps are turned off and, at the same time, the valves are closed to capture the oil and water in the line. After a certain standstill period, the valves are opened

Fig. 2 Fouling of the INTEVEP test loop with Zuata crude. Water input fraction = 4 %, superficial oil velocity = 1.5 m/s. Monotonical pressure increase as pipeline fouds. High blockage was experienced after 2.5 days of operation

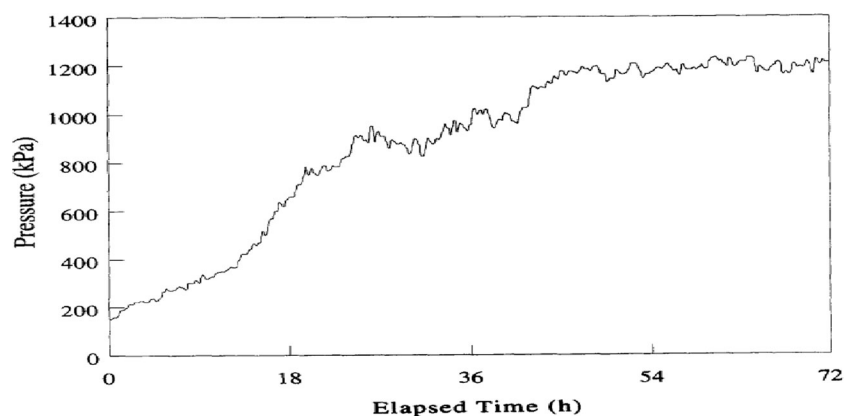

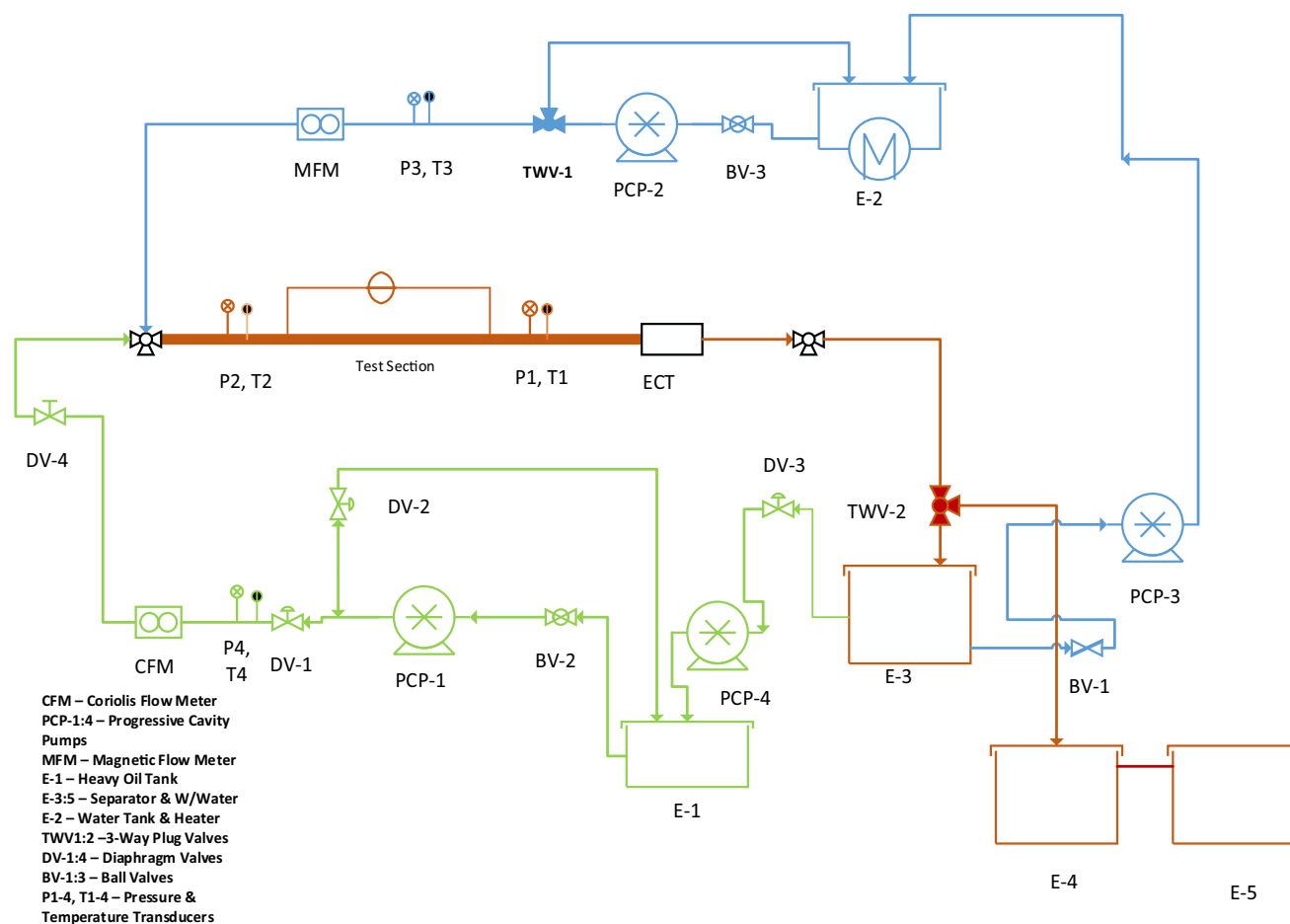

Fig. 3 Schematic of the Experimental section of the 1-inch Test Rig

Table 1 Experimental conditions for the shutdown and restart experiments

| Parameters/conditions | Values |
|-------------------------------------|--|
| Water density, ρ_w | 998 kg/m ³ |
| Oil density, ρ_o | 903–915 kg/m ³ |
| Water viscosity, μ_w | 0.001 kg m ⁻¹ s ⁻¹ |
| Oil viscosity, μ_o | 1.9–3.883 kg m ⁻¹ s ⁻¹ |
| Oil holdup | 0.62 and 0.66 |
| Water cleaning superficial velocity | 0.2 and 0.6 m/s |
| Standstill periods | 1, 3, 20 h |
| Pipe angle | 0° |
| Oil–water surface tension | 0.02 N/m |

and the water pump turned on at the same time with water flowing at the desired superficial velocity. Data measurements are made for the core annular flow mode, immediately after shutdown and prior to restart for 30 s at sampling rate of 250 Hz. While during the cleaning process, data measurements are collected at sampling rate of 50 Hz until the pressure drop value is almost equal to

single-phase water flow. The oil holdup is computed using Oliemans and Ooms (1986) correlation.

$$C_w = C_w \left(1 + (1 - C_w)^5 \right) \quad (1)$$

Experimental results analyses

A summary of the experimental results is presented in Table 2. Figures 4, 5, 6, 7, 8 and 9 show some of the results of the transient pressure drops for different standstill periods, viscosities, oil holdups and water cleaning superficial velocities.

As can be seen, the drop starts around 5.2–18.4 kPa and decreases to a value near the steady-state pressure drop of single-phase water flow. The pipe was not completely clean, very thin oil film still remains at the top section of the pipe. This is perhaps due to the superficial water velocity used which was insufficient to provide the momentum needed to shear the oil from that section of the pipe. In all cases, the transient behaviour of the pressure drop exhibits a particular trend. It seems to have two major

Table 2 Summary of experimental results

| Test S/no | CAF | | | μ_o , Kg/m/s | Standstill periods (h) | Oil holdup | ΔP_i , kPa | Restart time, Δt , s | Cleaning Water superficial velocities, m/s |
|-----------|----------------|----------------|------------------|------------------|------------------------|------------|--------------------|------------------------------|--|
| | U_{so} , m/s | U_{sw} , m/s | ΔP , kPa | | | | | | |
| 1 | 0.5 | 0.2 | 1.93 | 1.936 | 1 | 0.66 | 6.8 | ≈ 3300 | 0.2 |
| 2 | 0.5 | 0.2 | 1.93 | 1.936 | 3 | 0.66 | 5.6 | ≈ 3300 | 0.2 |
| 3 | 0.5 | 0.2 | 1.93 | 1.936 | 20 | 0.66 | 5.2 | ≈ 3300 | 0.2 |
| 4 | 0.4 | 0.2 | 1.79 | 3.236 | 1 | 0.62 | 6.4 | ≈ 3300 | 0.2 |
| 5 | 0.4 | 0.2 | 1.79 | 1.936 | 1 | 0.62 | 10.6 | ≈ 1650 | 0.6 |
| 6 | 0.4 | 0.2 | 1.79 | 1.936 | 3 | 0.62 | 11 | ≈ 1650 | 0.6 |
| 7 | 0.4 | 0.2 | 1.79 | 1.936 | 20 | 0.62 | 12.9 | ≈ 1650 | 0.6 |
| 8 | 0.4 | 0.2 | 3.6 | 3.883 | 1 | 0.62 | 18.4 | ≈ 1800 | 0.66 |
| 9 | 0.4 | 0.2 | 2.25 | 3.8 | 3 | 0.62 | 17.1 | ≈ 1800 | 0.62 |
| 10 | 0.4 | 0.2 | 2.02 | 3.721 | 20 | 0.62 | 14.8 | ≈ 1800 | 0.63 |
| 11 | 0.5 | 0.2 | 3.43 | 3.030 | 1 | 0.66 | 16.5 | ≈ 1800 | 0.62 |
| 12 | 0.5 | 0.2 | 3.3 | 2.854 | 3 | 0.66 | 16.8 | ≈ 1800 | 0.62 |
| 13 | 0.5 | 0.2 | 3.12 | 2.847 | 20 | 0.66 | 13.7 | ≈ 1800 | 0.579 |

Fig. 4 Pressure drop profile during cleanup with $U_{sw} = 0.2$ m/s for standstill period of 3 h

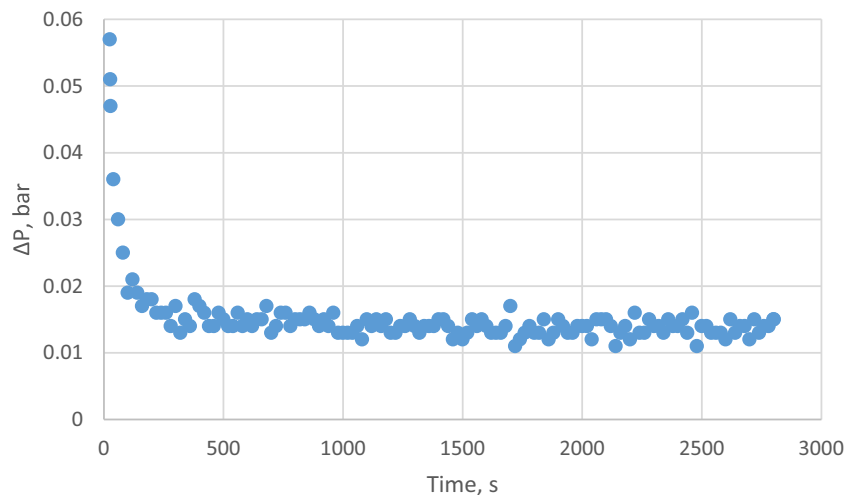
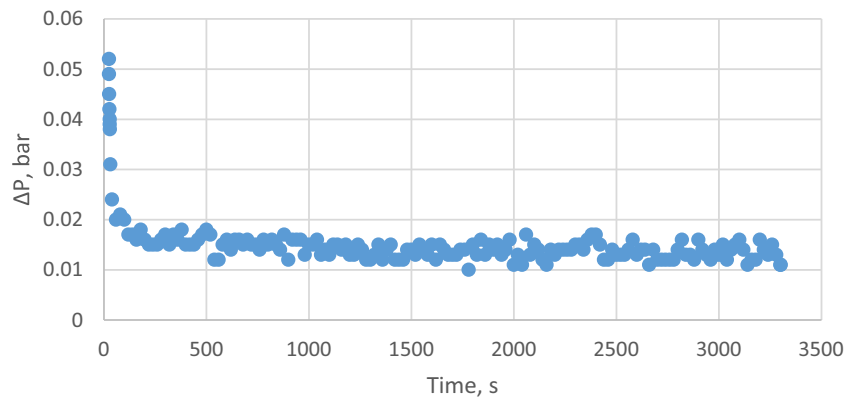

Fig. 5 Pressure drop profile during cleanup with $U_{sw} = 0.2$ m/s for standstill period of 20 h



parts: the first, which happens rapidly is due to the bulk shearing of the oil by the water. This occurs in less than a minute and the pressure drops to about 90 % of the initial

recorded pressure drop during the restart process. The second part which occurs for a longer time accounts for the pressure drop during the gradual removal of the thin layer

Fig. 6 Pressure drop profile during cleanup with $U_{sw} = 0.62$ m/s for standstill period of 1 h (Test No. 4)

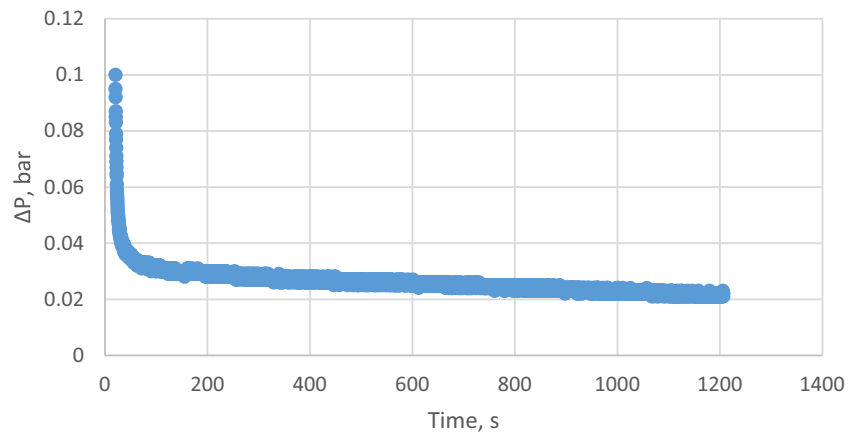

Fig. 7 Pressure drop profile during cleanup with $U_{sw} = 0.6$ m/s for standstill period of 3 h (Test No.6)

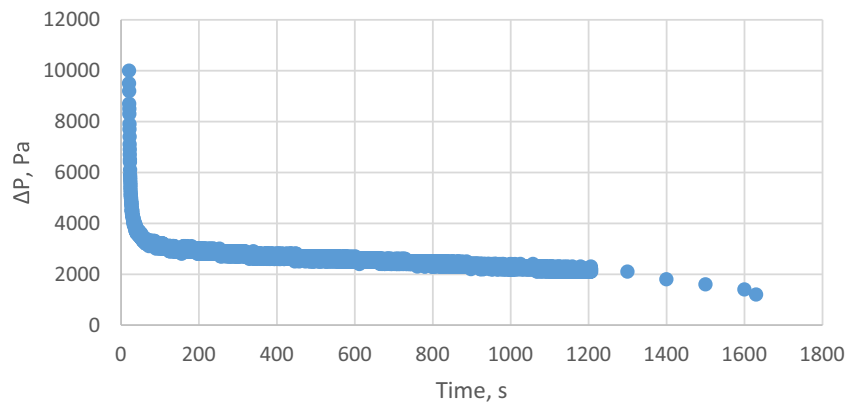
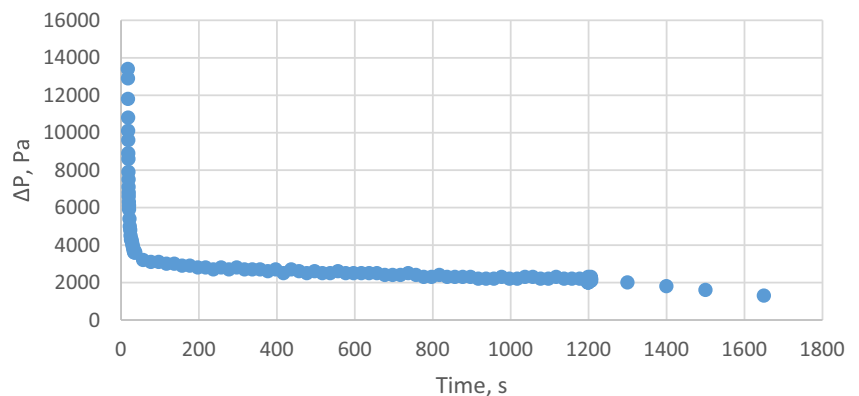

Fig. 8 Pressure drop profile during cleanup with $U_{sw} = 0.6$ m/s for standstill period of 20 h (Test No. 7)



of oil at the top section of the pipe; the shear velocity of the oil drops gradually. For cases with water cleaning velocity of 0.2 m/s, fluctuations of pressure drop evolution were observed at the latter stage.

The oil holdups and standstill periods do not appear to have a great influence on the pressure drop evolution. However, the oil viscosities and superficial velocities of the cleaning water seem to significantly affect the pressure drops at the inception of the cleaning process. This may be as a result of the high resistance offered by the trapped oil in the pipe and also the high initial impact between the

trapped fluid and the cleaning water with high superficial velocities.

It was really difficult to measure the restart time, however, data recording during the cleaning process were set to be recorded for 1 h, and by monitoring the recording chart of the inlet and outlet pressure signals, the recording process was stopped when the pressure signals were virtually close to pumping water only. As given in Table 2, restart time, which is the cleaning time required to reach an oil-free pipe condition when only water is introduced in the pipe, ranges from 1650 to 3300 s.

Fig. 9 Pressure drop profile during cleanup with $U_{sw} = 0.6$ m/s for standstill period of 1 h (Test No. 5)

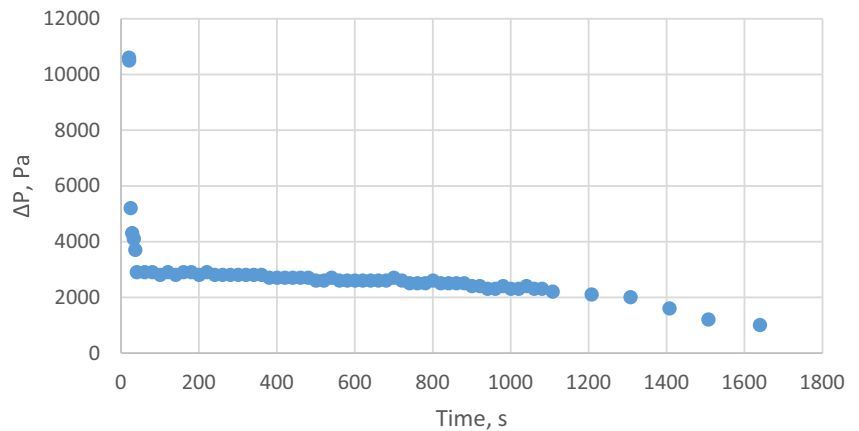
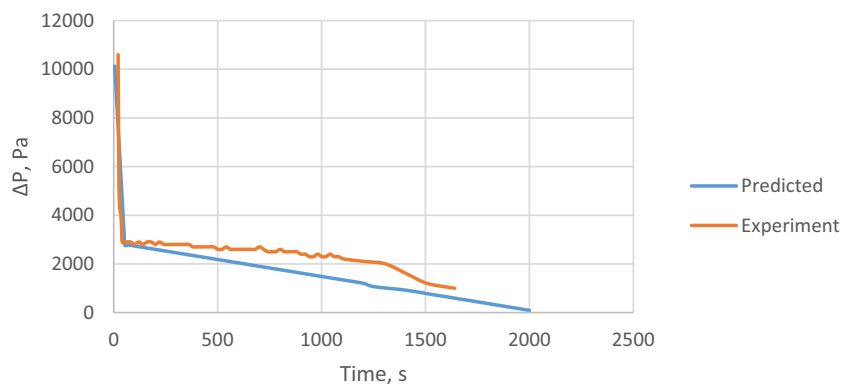

Table 3 Results summary of restart time predictions with input data

| Test | D (m) | L (m) | h_o | U_{sw} (m/s) | μ_w ($\text{kg m}^{-1} \text{s}^{-1}$) | μ_o ($\text{kg m}^{-1} \text{s}^{-1}$) | ΔP_i (Pa) | Δt Exp. (s) | Δt Pred. (s) | APE (%) |
|------|---------|---------|-------|----------------|--|--|-------------------|---------------------|----------------------|-----------|
| 1 | 0.026 | 5.5 | 0.66 | 0.2 | 0.001 | 1.936 | 6800 | ≈ 3300 | 5586.134 | 69.27 |
| 2 | 0.026 | 5.5 | 0.66 | 0.2 | 0.001 | 1.936 | 5600 | ≈ 3301 | 5586.134 | 69.2 |
| 3 | 0.026 | 5.5 | 0.66 | 0.2 | 0.001 | 1.936 | 5200 | ≈ 3302 | 5586.134 | 69.27 |
| 4 | 0.026 | 5.5 | 0.62 | 0.2 | 0.001 | 3.236 | 6400 | ≈ 3303 | 5247.581 | 59.0 |
| 5 | 0.026 | 5.5 | 0.62 | 0.6 | 0.001 | 1.936 | 10600 | ≈ 1650 | 1749.194 | 6.01 |
| 6 | 0.026 | 5.5 | 0.62 | 0.6 | 0.001 | 1.936 | 11000 | ≈ 1650 | 1749.194 | 6.0 |
| 7 | 0.026 | 5.5 | 0.62 | 0.6 | 0.001 | 1.936 | 12900 | ≈ 1650 | 1749.194 | 6.0 |
| 8 | 0.026 | 5.5 | 0.62 | 0.66 | 0.001 | 3.883 | 18400 | ≈ 1800 | 1590 | 11 |
| 9 | 0.026 | 5.5 | 0.62 | 0.6 | 0.001 | 3.8 | 17100 | ≈ 1800 | 1749 | 2.82 |
| 10 | 0.026 | 5.5 | 0.62 | 0.6 | 0.001 | 3.721 | 14800 | ≈ 1800 | 1749 | 2.82 |
| 11 | 0.026 | 5.5 | 0.66 | 0.62 | 0.001 | 3.030 | 16500 | ≈ 1800 | 1801 | 0.10 |
| 12 | 0.026 | 5.5 | 0.66 | 0.597 | 0.001 | 2.854 | 16800 | ≈ 1800 | 1871 | 3.96 |
| 13 | 0.026 | 5.5 | 0.66 | 0.579 | 0.001 | 2.847 | 13700 | ≈ 1800 | 1929 | 7.19 |

Fig. 10 Transient pressure drops comparison between experiment and correlations for Test No. 5



Correlation formulation

The development of a realistic correlation which can be of practical importance during the engineering design of high-viscous oil pipeline transportation facility for predicting restart process is presented as follows.

The correlation is based primarily on the assumption that the pressure drop evolution decreases with incremental volume of water used to completely clean the pipe. This decrease is in two parts (a and b) as earlier observed in the experiments conducted. A dimensional analysis method was adopted to normalize the pressure drop trend considering that

Fig. 11 Transient pressure drops comparison between experiment and correlations for Test No. 6

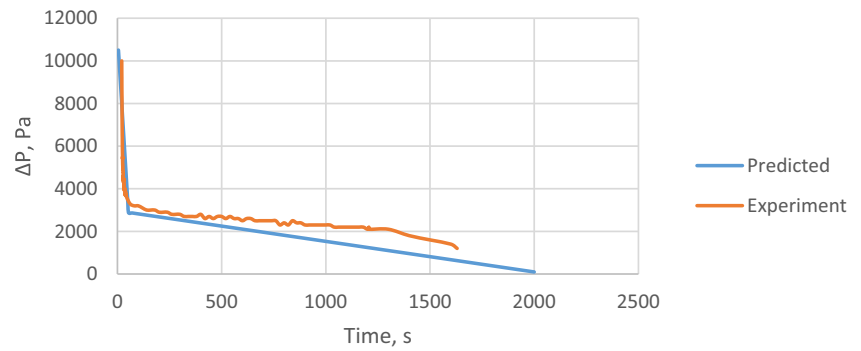

the dynamic properties and the flow behaviour can be different for any CAF line, and the concept can be described by the following functional relation:

$$f(\Delta P(t), (\Delta P_i), (\Delta P_w), \mu_o, \mu_w, h_o, U_{sw}, L, t, t^*, \Delta t, V_D, V) = 0 \tag{2}$$

Then, a generalized correlation among the dimensionless groups has been formulated by multiple regression analysis using the data from the present experimental results. The details of the dimensional analyses are not described here.

The slopes of the two parts of the pressure drop trends are expressed as follows:

$$Z = \left(\frac{\Delta P(t^*) - \Delta P(t)}{\Delta P_i - \Delta P_w} \right) \frac{V_D}{V(t^*)} \tag{3}$$

$$Y = \frac{\frac{\Delta P(\Delta t) - \Delta P_w}{\Delta P_i - \Delta P_w} - \frac{\Delta P(t^*) - \Delta P_w}{\Delta P_i - \Delta P_w}}{\frac{V(\Delta t)}{V_D} - \frac{V(t^*)}{V_D}} \tag{4}$$

From the analysis we have estimated the values of, Z, Y, t*, and ΔP(t*), and solving for the restart time, Δt, we get:

$$\Delta t = \frac{1344h_oL}{U_{sw}} \left\{ \left[0.008 + \left(\frac{\Delta P(t^*) - \Delta P_w}{\Delta P_i - \Delta P_w} \right) \right] \right\} \tag{5}$$

Other relevant correlations are as follows:

$$\Delta P(t^*) = \Delta P_w + 0.221 [\Delta P_i - \Delta P_w] \tag{6}$$

$$t^* = \frac{12.51h_oL}{U_{sw}} \left[1 - \frac{\Delta P_w + 0.221(\Delta P_i - \Delta P_w)}{\Delta P_i - \Delta P_w} \right] \tag{7}$$

For the first part, a, of the slope, where t < t*, the pressure drop trends can be estimated with

$$\text{Part a : } \Delta P(t) = (\Delta P_i + \Delta P_w) \left[1 - \left(\frac{0.07989U_{sw}t}{h_oL} \right) \right] \tag{8}$$

For the second part, b, of the slope, where t > t*, the pressure drop trends can be calculated with

$$\text{Part b : } \Delta P(t) = (\Delta P(t^*) + \Delta P_w) \left[1 - \left(\frac{0.00275U_{sw}t}{h_oL} \right) \right] \tag{9}$$

The pressure drop, ΔP_w, for the water single-phase flow can be estimated using the standard formula of pressure drop for horizontal pipe:

$$\Delta P_w = \frac{2f_w U_{sw}^2 L}{D} \tag{10}$$

$$f_w = \frac{16}{Re} \quad \text{for } Re < 2100 \tag{11}$$

$$f_w = \frac{0.079}{Re^{0.25}} \quad \text{for } Re > 2100 \tag{12}$$

Fig. 12 Transient pressure drops comparison between experiment and correlations for Test No. 7

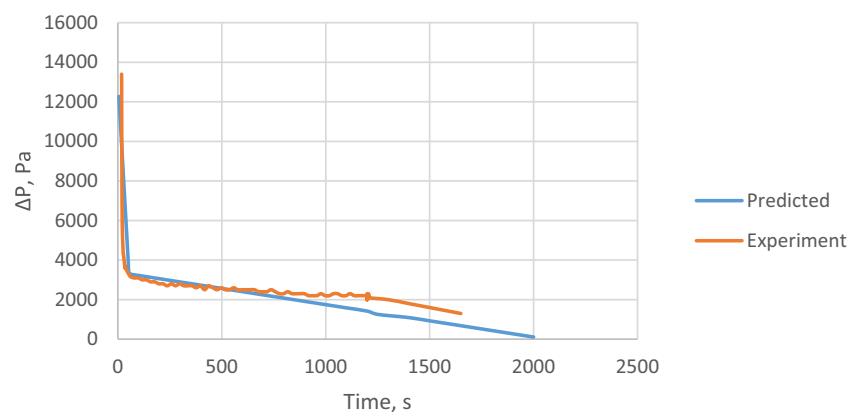

$$Re = \frac{DU_{sw}\rho_w}{\mu_w} \tag{13}$$

The initial pressure drop, ΔP_i , imposed to the blocked pipe at the inception of the restart process can be estimated using a reliable one-dimensional two-phase liquid–liquid pressure drop model for a stratified flow configuration, and assuming that the oil and water superficial velocities are the same.

A typical example of stratified flow of a two-fluid model for horizontal pipe is

$$\frac{\tau_o S_o}{A_o} - \frac{\tau_w S_w}{A_w} + \tau_i S_i \left(\frac{1}{A_w} + \frac{1}{A_o} \right) = 0 \tag{14}$$

τ_w, τ_o, τ_i are the water wall, oil wall and interfacial shear stresses, respectively, while S_i, S_o, S_w are the wall-wetted perimeters of the interfacial, oil and water, respectively, and A_o, A_w represent the areas of the oil and water phases.

Results comparison between experiments and the new correlation

To examine the predictive capabilities of the new correlations, results comparison between the experimental data and the new correlations for predicting the restart process is performed. The data introduced in the correlations are summarized in Table 3. Equations 5, 6, 7, 8, 9 were used in the analyses. The new correlation overpredicts the restart time when compared to the experimental data especially those with the lower superficial velocities (0.2 m/s) of the cleaning water. For the 0.6 m/s superficial velocities, the results were quite in agreement with a very slight deviation of ± 0.13 –11 %. Though the phenomenon involved in the cleaning process is complex and depends upon a lot of several parameters, the significance of the superficial

velocities of the cleaning water is quite high as shown in the results obtained. The predicted restart time results using the above-mentioned correlations are also given in Table 3, along with the data used and percentage error in prediction. New and careful experiments could be conducted to confirm more on the validity of the restart correlations. The error given in Table 3 is the absolute percentage error and is calculated using the following expression:

$$APE = \frac{\Delta t_{Pred.} - \Delta t_{Exp.}}{\Delta t_{Exp.}} \times 100 \tag{15}$$

However, in qualitative terms, the pressure drop trend predictions were in good agreement with the experimental data. This is shown in Figs. 10, 11, 12, 13 and 14.

Conclusion

The laboratory results of shutdown and restart experiments of high-viscous oil conducted in a 5.5-m-long PVC horizontal pipe with internal diameter of 26 mm has been used to formulate correlations for the prediction of restart process of a core annular flow line. The new correlations overpredict the restart time when compared to the experimental data especially those with the lower superficial velocities (0.2 m/s) of the cleaning water, but for the 0.6 m/s superficial velocities, the results were quite in agreement with a very slight deviation of 6 %. In qualitative terms, the pressure drop evolution predictions were in good agreement with the experimental data. New and careful experiments under various pipe and fluid properties should be conducted to confirm more on the validity of the restart correlations. On a wider application, the predictive capability of the new correlations should be checked with experimental results obtained from different cleaning liquids (enhanced water) other than cold water. We also want

Fig. 13 Transient pressure drops comparison between experiment and correlations for Test No. 3

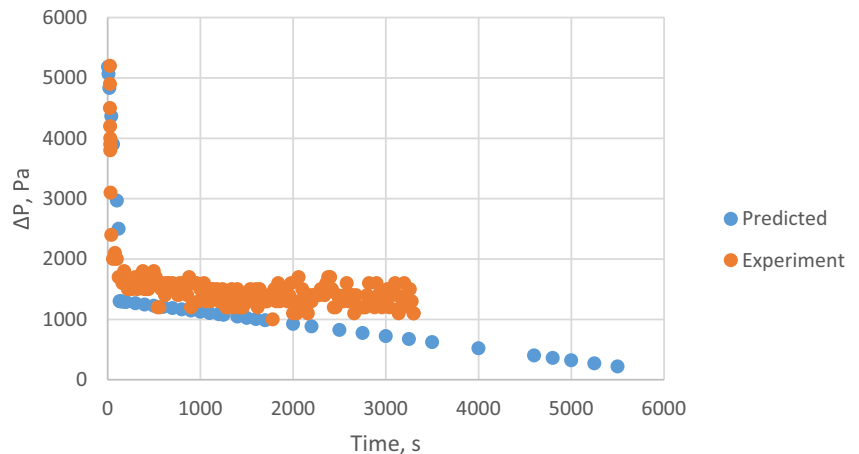
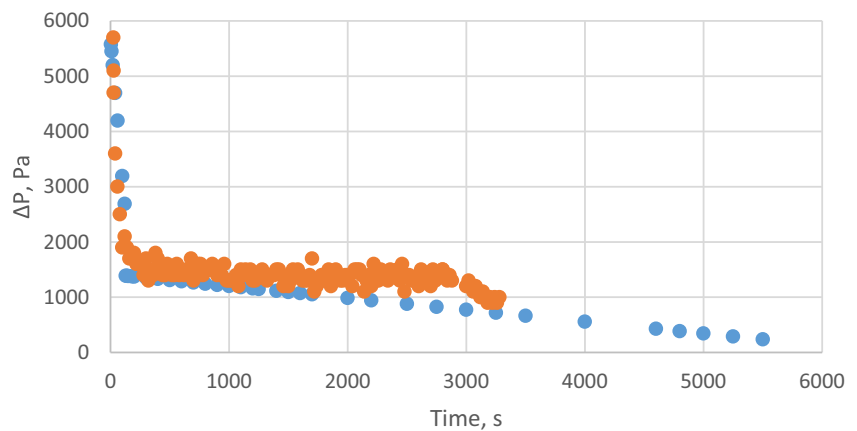

Fig. 14 Transient pressure drops comparison between experiment and correlations for Test No. 2



to state that the new correlation can be better applied to a cold water restart and to heavy oil with API gravity greater than 10° .

Open Access This article is distributed under the terms of the Creative Commons Attribution 4.0 International License (<http://creativecommons.org/licenses/by/4.0/>), which permits unrestricted use, distribution, and reproduction in any medium, provided you give appropriate credit to the original author(s) and the source, provide a link to the Creative Commons license, and indicate if changes were made.

References

- Adeyemi VA, Ogunsola AO (1993) Optimal formulation of caustic systems for emulsion transportation and dehydration of heavy oil. *Chem Eng Res Des* 71:62–68
- Arney MS, Ribeiro GS, Guevara E, Bai R, Joseph DD (1996) Cement-lined pipes for water lubricated transport of heavy oil. *Int J Multiph Flow* 22:207–221
- Bannwart AC, Rodriguez OMH, de Cavalho CHM, Wang IS, Vara RMO (2004) Flow patterns in heavy crude oils. *J Energy Res Tech* 126:184–189
- Barbosa A., Bannwart A.C., and Ribeiro G.S., (2005) Pressure drop and restart time during stop-and-go experiments in core annular flow. In: 18th International Congress of Mechanical Engineering November 6–11, Ouro Preto
- Bannwart AC, Barbosa A, Ribeiro GS (2007) A model for interpretation of a re-start experiment of viscous oil-water annular flow. In: *Proceedings of the IASTED International Conference on Modelling and Simulation*, pp 215–220
- Bensakhria A, Peysson Y, Antonini G (2004) Experimental study of the pipeline lubrication for heavy oil transport. *Oil Gas Sci Technol* 59(5):523–533
- Brauner N (2004) Liquid-liquid two-phase flow systems. In: Bertola V (ed) *Modeling and control of two-phase flow phenomena*. CISM Center, Udine, Italy
- da Silva RCR, Mohamed RS, Bannwart AC (2006) Wettability alteration of internal surfaces of pipelines for use in the transportation of heavy oil via core-flow. *J Pet Prod Sci Eng* 51:17–25
- Dos Santos RG, Mohamed RS, Bannwart AC, Loh W (2006) Contact angle measurements and wetting behaviour of inner surfaces of pipelines exposed to heavy crude oil and water. *J Petrol Sci Eng* 51:9–16
- Ghosh S, Mandal TK, Das G, Das PK (2008) Review of oil water core annular flow. *Renew Sustain Energy Rev* 13:1957–1965
- Joseph DD, Renardy YY (1993) *Fundamentals of two-fluid dynamics*. Springer-Verlag, New York
- Joseph DD, Chen KP, Renardy YY (1997) Core-annular flows. *Annu Rev Fluid Mech* 29:65–90
- Ngan KH, Linnenberg S, Al-Wahibi T, Angeli P (2007) Effect of drag reducing polymers on oil-water flow. In: *6th International Conference on Multiphase Science and Technology vol 2*, pp 427–476
- Oliemans RVA, Ooms G (1986) Core-annular flow of oil and water through a pipeline. In: Hewitt GF, Delhaye JM, Zuber N (eds) *Multiphase science and technology, Vol. 2*. Washington: Hemisphere
- Peysson Y, Bensakhira A, Antonini G (2005) Pipeline lubrication of heavy oil: experimental investigation of flow and restart problems. SPE 97764 first presented at 2005 SPE Internal Thermal Operations and Heavy Oil Symposium, Calgary, 1-3 November, revised publication, 2007
- Poesio P, Strazza D (2007) Experiments on start-up of an oil-water core annular flow through a horizontal or nearly horizontal pipe. In: *13th International Conference on Multiphase Production Technology BHR Group 2007*, Edinburgh (UK)
- Ramos, Antonio CS (2001) *Asfaltenos em Petroleos Brasileiros: Agregacao em solvents aromaticos, desenvolvimento de aditivos estabilizacao de emulsoes*. Dissertation, University of Campinas, Brasil, (UNICAMP)
- Saniere A, Henaut I, Argillier JF (2004) Pipeline transportation of heavy oils, a strategic, economic and technological challenge. *Oil Gas Sci* 59(5)
- Strazza D, Poesio P (2012) Experimental study on the restart of core-annular flow. *Chem Eng Res Des* 90(11):1711–1718
- Vanegas, JW (1999) *Estudo Experimental do Escoamento Anular oleo-agua (Core-Flow) na Elevacao de oleos Ultrviscosos*. Dissertation, University of Campinas, Brasil, (UNICAMP)
- Zagustin K, Guevara E, Nunez G, (1988) Process for restarting core flow with very viscous oils after a long standstill period. US Patent 4745937